

Specification

System	
Processor	3rd Generation Intel® Quad Core™ i7/i5/i3 Ivy Bridge Processors (6M Cache, up to 3.30 GHz)
Chipset	Intel® Mobile QM77
BIOS	AMI
SIO	IT8783F
Memory	DDR3 1066 / 1333 / 1600 MHz, DDR3L 1066 / 1333 MHz 16GB Max., 2 204-pin SO-DIMM Sockets
I/O Port	
Serial Interface	3 COM RS-232, 1 COM RS-232 / 485 / 422
USB	4 USB 3.0, 2 USB 2.0, 2 Internal USB 2.0
Isolated DIO	8 DI, 8 DO (Optional)
LED	Power, SDD and CFAST LEDs
GPIO	16 GPIO
Expansion	
Mini PCIe	1 miniPCIe Socket: PCIe + USB + SIM Card Socket 1 miniPCIe Socket: PCIe + USB
SUMIT A, B	2 SUMIT Slots (Optional)
JST Connector	1 Internal 6-pin (Internal USB 2.0)
Graphics	
Chipset	Intel® GMA HD 4000
Display Memory	Shared Memory, Up to 1.7GB
Interface	DB-15 VGA / 1920 x 1200 Max. DVI-D / 1920 x 1200 Max. Display Port 1 / 2560 x 1600 Max. Display Port 2 / 1920 x 1200 Max. LVDS / Dual Channel 24-bit / 1920 x 1200 Max.
Storage	
SATA	2 SATA III 6Gbps 1 SATA II 3Gbps - Support Horizontal Type SATA DOM
mSATA	2 SATA II 3Gbps
Storage Expansion	CFAST Slot Push In / Out Ejector
Audio	
Audio Codec	Realtek ALC892, 5.1 Channel HD Audio
Audio Interface	Line-in, Line-out, Mic-in, Front Audio Header
Ethernet	
LAN1	Intel® 82579LM Gigabit LAN, Wake on LAN, PXE Support
LAN2~6	Intel® 82574L Gigabit LAN, Wake on LAN, PXE Support
Power	
Power Input	1 Mini DIN One 3-pin Terminal Block for DC-IN : V+, V-, Frame Ground
Power Input Voltage	DC-IN 6 ~ 36V
Power Adapter	AC to DC +24V / 5A 120W Max. (Optional)
Protection	On-board LT4356 for Power Input High Voltage Surge Protection
Other	
Trusted Platform Module (TPM)	Infineon SLB9635, LPC interface (Optional)
Watchdog Timer	Reset: 1 to 255 sec / min Per Step
HW Monitor	Temperature / Voltages Auto Throttling Control When CPU Overheats
Mechanical	
Chassis Construction	Aluminum Housing
Size(W x D x H)	260mm x 175mm x 79mm (10.2" x 6.9" x 3.1")
Weight	2.8Kg (6 lb)
Mounting	Wall-mount by Mounting Bracket
Environment	
Operating Temperature	-25°C to 70°C (-13°F to 157°F)
Storage Temperature	-40°C to 85°C (-40°F to 185°F)
Humidity	10% to 95% Humidity, Non-condensing
Relative Humidity	95% at 70°C
Vibration	Random: 0.5Grms @5~500 Hz according to IEC68-2-64 Sinusoidal: 0.5Grms @5~500 Hz according to IEC68-2-64
Shock	Operating, 20 Grms, Half-sine 11 ms Duration (w / SSD, According to IEC60068-2-27)
EMC	CE / FCC Class A

*All product specifications are subject to change without prior notice.

Order Information

Part Number	Description
ECS-7000-6GDE	6 GbE LAN Fanless Embedded Controller, 2 HDD, Isolated DIO, SUMIT (A, B), iAMT 8.0
ECS-7000-6GD	6 GbE LAN Fanless Embedded Controller, 2 HDD, Isolated DIO, iAMT 8.0
ECS-7000-6R	6 GbE LAN Fanless Embedded Controller, 2 Front Panel Access Removable HDD with Key Lock, iAMT 8.0
ECS-7000-6G	6 GbE LAN Fanless Embedded Controller, 2 HDD, iAMT 8.0
ECS-7000-2R	2 GbE LAN Fanless Embedded Controller, 2 Front Panel Access Removable HDD with Key Lock
ECS-7000-2G	2 GbE LAN Fanless Embedded Controller, 2 HDD
Part Number	Description
i7-3610QE	Ivy Bridge 3rd Gen Intel® Mobile Quad-Core™ i7 Processor
i5-3610ME	Ivy Bridge 3rd Gen Intel® Mobile Core™ i5 Processor
i3-3120ME	Ivy Bridge 3rd Gen Intel® Mobile Core™ i3 Processor
M340S-W28M1	Vecow DDR3 4GB 1333/1066MHz RAM, Wide Temperature -40°C ~ +85°C
KVR1333D3S9/8G	Kingston® DDR3 8GB PC1333 RAM
KVR1333D3S9/4G	Kingston® DDR3 4GB PC1333 RAM
PWA-120WM4P	120W, 24V, 90VAC to 264VAC power adapter
SCSI-20P-100	20-in SCSI Cable, 1M
TMB-SCSI-20P	Terminal Board with One 20-pin SCSI Connector and DIN-Rail Mounting
WiFi Module	Intel® MiniPCIe WiFi Module with Antenna

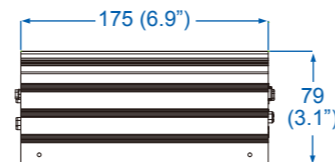
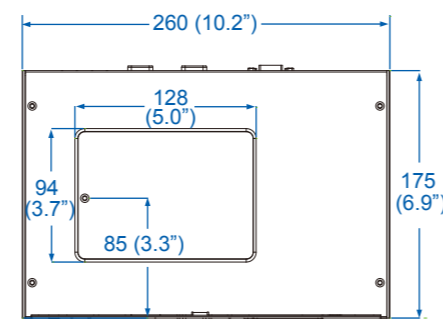
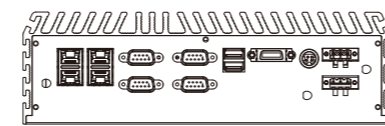
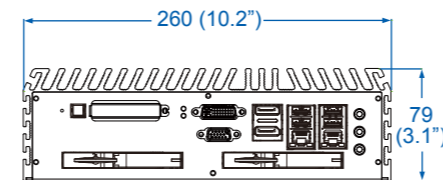
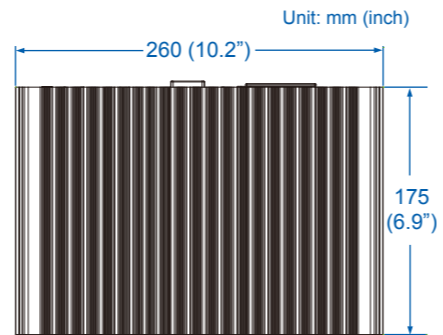

ECS-7000 series

High Performance, Rugged, Extended Temp, Fanless Embedded System with 6 GbE and Intel® QM77 Express Chipset & Choice of 3rd Gen. Intel® Quad Core™ i7/i5/i3 Mobile Processor



- 3rd Gen Intel® Quad Core™ i7/i5/i3 Ivy Bridge Mobile Processor (6M Cache, up to 3.30 GHz)
- Fanless, -25°C to 70°C Operation Temperature
- 6 GbE LANs for Extended Internet Application
- QM77 System Chipset
- Support 2 SO-DIMM DDR3 or DDR3L, up to 16GB
- Isolated 8 DI / 8 DO, GPIO 8 DI / 8 DO
- 2 SATA III (6Gbps) 2.5" HDD / SSD, mSATA
- Built-in Input 80 V_{DC} Overvoltage Protection
- Rich I/O: 4 COM, 4 USB 3.0, 2 USB2.0, 2 Mini-PCIe (1 with SIM Card Socket)
- 5 Display Support: 2 DP, DVI-D, VGA, LVDS
- 3 Independent Displays
- Intel® AMT 8.0 Support
- Onboard Trusted Platform Module (Optional)

ECS-7000 series support 3rd Gen Intel® Quad-Core™ series processor (6M Cache, up to 3.30 GHz), DDR3L and DDR3 maximum dual channel 16GB ram, 3 independent display (DP, DVI-D, and VGA), isolated DIO, maximum 6 GbE LANs, CFAST, two 2.5" SATA 6Gp/s HDD/SSD trays, 4 COM, 4 USB 3.0 ports, JST connector, and 2 miniPCI-express, plus with overvoltage protection and Trusted Platform Module which making ECS-7000 series stand out from others in machine vision and GigE imaging, intelligent automation, surveillance and security, and most of embedded applications. ECS-7000 full series powered by cutting-edge the 3rd Gen Intel® Quad-Core™ i7 Processor (6M Cache, up to 3.3 GHz) not only increasing power efficiency as much as 25% also integrates Intel® HD 4000 graphics and extremely low thermal design power as 35W providing an enhanced reliability, safety and shock resistance for fanless operation required environments. Maximum 6 GbE LAN, ECS-7000 series provide stable and speedy Ethernet with 9.6 kb/s to 1 Gb/s data transmission option for high bandwidth and supports Ethernet Control Automation Technology (EtherCAT).



ECS-7000 series Performance Fanless Embedded System

High Performance, Rugged, Extended Temp, Fanless Embedded System with 6 GbE and Intel® QM77 Express Chipset & Choice of 3rd Gen. Intel® Quad Core™ i7/i5/i3 Mobile Processor

ISOLATED DIO



ECS-7000-6GDE



Ideal industrial system solution, ECS-7000-6GDE model equipped with 6 GbE LAN, Isolated DIO 8 DI, 8 DO, and SUMIT interface to provide greater effective data transfer rates. ECS-7000-6GDE model also enables 3rd Gen Intel® Quad-Core™ series processor (6M Cache, up to 3.30 GHz), 4 COM, 4 USB 3.0 ports, JST connector, and 2 miniPCI-express, plus with overvoltage protection and Trusted Platform Module.



ECS-7000-6GD



Collecting most industrial useful interfaces, ECS-7000-6GD model has designed with isolated DIO 8 DI, 8 DO and GPIO 8DI, 8DO. Like all other ECS-7000 series, ECS-7000-6GD enables 3rd Gen Intel® Quad-Core™ series processor (6M Cache, up to 3.30 GHz), 2 SSD/HDD trays, 4 COM, 4 USB 3.0 ports, JST connector, and 2 miniPCI-express, plus with overvoltage protection and Trusted Platform Module.

GRAND



ECS-7000-6R



Featuring with 6 GbE LAN and 2 front panel accessible SSD/HDD trays, ECS-7000-6R model also enables 3rd Gen Intel® Quad-Core™ series processor (6M Cache, up to 3.30 GHz), 4 COM, 4 USB 3.0 ports, JST connector, and 2 miniPCI-express, plus with overvoltage protection and Trusted Platform Module.



ECS-7000-6G



For the outstanding console functions, ECS-7000-6G model has designed with 6 GbE LAN ports for various devices to communicate with microcontroller. ECS-7000-6G model not only enables 3rd Gen Intel® Quad-Core™ series processor (6M Cache, up to 3.30 GHz), 2 SSD/HDD trays, 4 COM, 4 USB 3.0 ports, JST connector, and 2 miniPCI-express, plus with overvoltage protection and Trusted Platform Module.

STANDARD



ECS-7000-2R



ECS-7000-2R supports 3rd Gen Intel® Quad-Core™ series processor (6M Cache, up to 3.30 GHz), 2 GbE LAN, 2 front panel access removable SSD/HDD trays with key locks, 4 COM, 4 USB 3.0 ports, JST connector, and 2 miniPCI-express, plus with overvoltage protection and Trusted Platform Module.



ECS-7000-2G



ECS-7000-2G supports 3rd Gen Intel® Quad-Core™ series processor (6M Cache, up to 3.30 GHz), 2 GbE LAN, 2 SSD/HDD trays, 4 COM, 4 USB 3.0 ports, JST connector, and 2 miniPCI-express, plus with overvoltage protection and Trusted Platform Module.

CUSTOMISED



Cost-Efficient



Customized

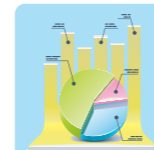

Quality

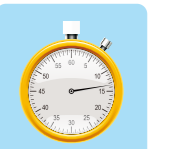
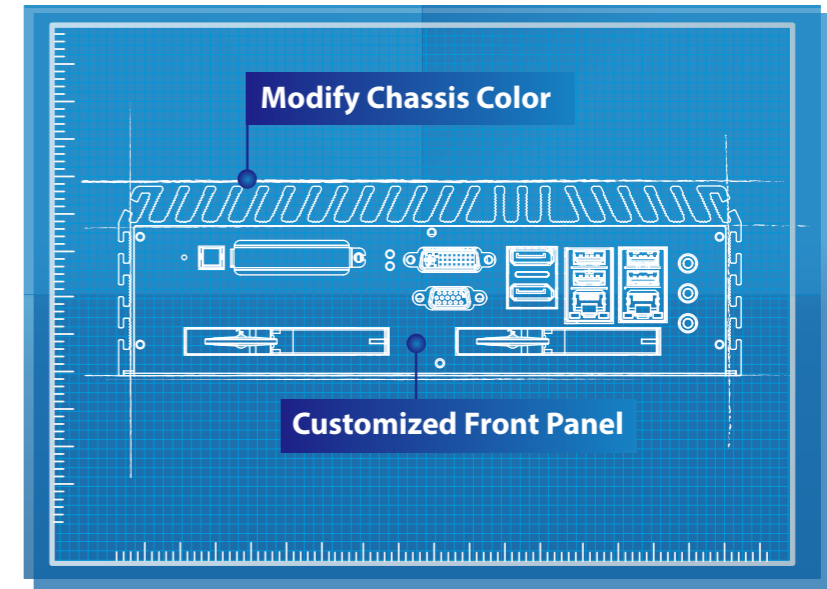

Time-To-Market

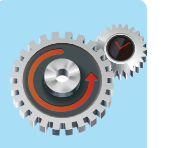

Integrated



Reliability



Industrial Plant



Machine Vision



Intelligent Manufacture System



Intelligent Automation



Medical & Health Care



Surveillance & Security (NVR)