

PC-HELPER

PCI Bus Expansion Chassis

Short x 2Slots

ECH(PCI)BE-H2B

Long x 2Slots

ECH(PCI)BE-F2B

Short x 4Slots

ECH(PCI)BE-H4B

Long x 4Slots

ECH(PCI)BE-F4B

User's Manual

CONTEC CO.,LTD.

Check Your Package

Thank you for purchasing the CONTEC product.

The product consists of the items listed below.

Check, with the following list, that your package is complete. If you discover damaged or missing items, contact your retailer

Product Configuration List

- Expansion chassis(One of the following) ...1
[ECH(PCI)BE-H2B, ECH(PCI)BE-F2B,
ECH(PCI)BE-H4B, ECH(PCI)BE-F4B]
- AC adapter ...1
- Power cable ...1
- This User's Manual ...1
- Slot cover(One of the following)
ECH(PCI)BE-H2B, ECH(PCI)BE-F2B ...2,
ECH(PCI)BE-H4B, ECH(PCI)BE-F4B ...4
- Board fixed screw(One of the following)
ECH(PCI)BE-H2B, ECH(PCI)BE-F2B ...2,
ECH(PCI)BE-H4B, ECH(PCI)BE-F4B ...4

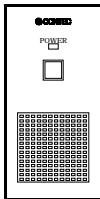

Expansion chassis(one of the following)
[ECH(PCI)BE-H2B, ECH(PCI)BE-F2B,
ECH(PCI)BE-H4B, ECH(PCI)BE-F4B]

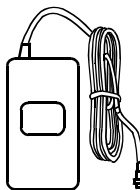

AC adapter

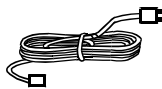

Power cable

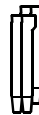

Slot cover(one of the following)
ECH(PCI)BE-H2B, ECH(PCI)BE-F2B x 2
ECH(PCI)BE-H4B, ECH(PCI)BE-F4B x 4



Board fixed screw(one of the following)
ECH(PCI)BE-H2B, ECH(PCI)BE-F2B x 2
ECH(PCI)BE-H4B, ECH(PCI)BE-F4B x 4

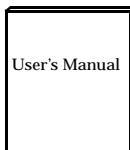

User's Manual

User's Manual

Copyright

Copyright 2004 CONTEC CO., LTD. ALL RIGHTS RESERVED.

No part of this document may be copied or reproduced in any form by any means without prior written consent of CONTEC CO., LTD.

CONTEC CO., LTD. makes no commitment to update or keep current the information contained in this document. The information in this document is subject to change without notice.

All relevant issues have been considered in the preparation of this document. Should you notice an omission or any questionable item in this document, please feel free to notify CONTEC CO., LTD.

Regardless of the foregoing statement, CONTEC assumes no responsibility for any errors that may appear in this document or for results obtained by the user as a result of using this product.

Trademarks

MS, Microsoft, Windows and Windows NT are trademarks of Microsoft Corporation. Other brand and product names are trademarks of their respective holder.

Table of Contents

Check Your Package.....	i
Copyright	ii
Trademarks	ii
Table of Contents.....	iii

1. BEFORE USING THE PRODUCT	1
------------------------------------	----------

About the Chassis	1
Features	1
Expansion adapter (Option).....	1
Combinations of Expansion Adapters and Expansion Chassis.....	2
Restrictions	3
Customer Support	4
Web Site.....	4
Limited Three-Years Warranty	4
How to Obtain Service	4
Liability.....	4
Safety Precautions	5
Safety Information.....	5
Handling Precautions.....	6
Environment.....	8
Inspection.....	8
Storage	8
Disposal	8

2. SETUP	9
-----------------	----------

What is Setup?	9
Step 1 Preparation.....	10
Items to be prepared.....	10
Names of major parts.....	11
Step 2 Installing the Expansion Board	12
Step 3 Connecting the Cable	13
Connecting the connection cable to the Expansion Adapter.....	13
Connecting the connection cable to the ECH(PCI)BE-H2B/F2B/H4B/F4B	13
Connecting the AC Adapter.....	14
Step 4 Installing the expansion adapter board.....	14
Step 5 Setup and Check	15
Starting the system.....	15
Setting up the hardware in Windows.....	16
Checking the hardware in Windows.....	16
Setup Troubleshooting.....	17
Symptoms and Actions	17

3.	ABOUT HARDWARE	19
----	----------------	----

Hardware specification	19
------------------------------	----

1. Before Using the Product

This chapter provides information you should know before using the product.

About the Chassis

The ECH(PCI)BE-H2B/F2B/H4B/F4B is an expansion chassis that adds PCI bus expansion slots to a PC by being connected to the PC via an optional expansion adapter EAD(PCI)BE, EAD(LPCI)BE, EAD(CB)BE, or EAD-BE1-LPE.

Features

- Capable of adding PCI bus (5V/32-bit, 33MHz) slots.
ECH(PCI)BE-H2B/F2B can add 2 slots.
ECH(PCI)BE-H4B/F4B can add 4 slots.
- Accepting PCI bus boards.
ECH(PCI)BE-H2B/H4B : Accepting short-size PCI bus boards.
ECH(PCI)BE-F2B/F4B : Accepting long-size PCI bus boards.
- Power supply controllable in response to the turning on/off of the PC's power supply.
- Built-in cooling fan
- Compact housing that enables a space-saving system to be constructed.

Expansion adapter (Option)

PCI Bus Expansion Adapter for CardBus PC-Slot : EAD(CB)BE
PCI Bus Expansion Adapter for PCI Bus PC-Slot : EAD(PCI)BE
PCI Bus Expansion Adapter for Low Profile PCI PC-Slot : EAD(LPCI)BE
PCI Bus Expansion Adapter for Low Profile PCI Express PC-Slot : EAD-BE-LPE
Check the CONTEC's Web site for more information on these expansion adapters.

Combinations of Expansion Adapters and Expansion Chassis

The expansion adapters and expansion chassis can be used in the following combinations:

Expansion adapter	Expansion chassis ECH(PCI)BE								
	-H2B	-F2B	-H4B	-F4B	-H4A	-H7A	-F7A	-H13A	-F13A
EAD(CB)BE	O	O	O	O	O	×	×	×	×
EAD(PCI)BE	O	O	O	O	O	O	O	O	O
EAD(LPCI)BE	O	O	O	O	O	O	O	O	O
EAD-BE1-LPE	O	O	O	O	O	O	O	O	O

Expansion chassis



ECH(PCI)BE-H2B ECH(PCI)BE-F2B ECH(PCI)BE-H4B ECH(PCI)BE-F4B



ECH(PCI)BE-H4A ECH(PCI)BE-H7A ECH(PCI)BE-F7A



ECH(PCI)BE-H13A ECH(PCI)BE-F13A

Expansion adapter



EAD(CB)BE EAD(PCI)BE EAD(LPCI)BE EAD-BE-LPE

Restrictions

ECH(PCI)BE-H2B/F2B/H4B/F4B has restrictions on the types of PCs and boards that can be used. Be sure to check the following restrictions before use.

< Restrictions of PC >

ECH(PCI)BE-H2B/F2B/H4B/F4B uses the PCI-to-PCI Bridge to extend the bus.

The PCI boards plugged in PCI slots in the ECH(PCI)BE-H2B/F2B/H4B/F4B are recognized if the PCI-to-PCI bridge is recognized by the BIOS in the PC used. Ask the PC vendor for whether the BIOS recognizes the PCI-to-PCI bridge.

< Restrictions on transfer rate >

When the expansion chassis accommodates a board that performs high-speed transfer such as bus mastering, the overall transfer rate may be lower than that of PCI bus slots in the main unit of a desktop PC.

This is caused by bus extension by the PCI-to-PCI Bridge.

The transfer rate may vary with the system configuration and the type of the PC.

< Restrictions of PCI board >

None of the following boards can be plugged into any expansion slot in the ECH(PCI)BE-H2B/F2B/H4B/F4B.

- Video display board (VGA board)
- Board to connect a PCI bus expansion chassis
- Board explicitly stated not to be used with the PCI-to-PCI Bridge
- Some boards, even PCI-compliant ones, may not work depending on their specifications

Customer Support

CONTEC provides the following support services for you to use CONTEC products more efficiently and comfortably.

Web Site

Japanese <http://www.contec.co.jp/>
English <http://www.contec.com/>
Chinese <http://www.contec.com.cn/>

Latest product information

CONTEC provides up-to-date information on products.

CONTEC also provides product manuals and various technical documents in the PDF.

Free download

You can download updated driver software and differential files as well as sample programs available in several languages.

Note! For product information

Contact your retailer if you have any technical question about a CONTEC product or need its price, delivery time, or estimate information.

Limited Three-Years Warranty

CONTEC products are warranted by CONTEC CO., LTD. to be free from defects in material and workmanship for up to three years from the date of purchase by the original purchaser.

Repair will be free of charge only when this device is returned freight prepaid with a copy of the original invoice and a Return Merchandise Authorization to the distributor or the CONTEC group office, from which it was purchased.

This warranty is not applicable for scratches or normal wear, but only for the electronic circuitry and original products. The warranty is not applicable if the device has been tampered with or damaged through abuse, mistreatment, neglect, or unreasonable use, or if the original invoice is not included, in which case repairs will be considered beyond the warranty policy.

How to Obtain Service

For replacement or repair, return the device freight prepaid, with a copy of the original invoice. Please obtain a Return Merchandise Authorization number (RMA) from the CONTEC group office where you purchased before returning any product.

* No product will be accepted by CONTEC group without the RMA number.

Liability

The obligation of the warrantor is solely to repair or replace the product. In no event will the warrantor be liable for any incidental or consequential damages due to such defect or consequences that arise from Safety Precautions.



Understand the following definitions and precautions to use the product safely.

Safety Precautions

Understand the following definitions and precautions to use the product safely.

Safety Information

This document provides safety information using the following symbols to prevent accidents resulting in injury or death and the destruction of equipment and resources. Understand the meanings of these labels to operate the equipment safely.

 DANGER	DANGER indicates an imminently hazardous situation which, if not avoided, will result in death or serious injury.
 WARNING	WARNING indicates a potentially hazardous situation which, if not avoided, could result in death or serious injury.
 CAUTION	CAUTION indicates a potentially hazardous situation which, if not avoided, may result in minor or moderate injury or in property damage.

Handling Precautions

DANGER

Do not use the product where it is exposed to flammable or corrosive gas. Doing so may result in an explosion, fire, electric shock, or failure.

CAUTION

- Do not plug or unplug any board into or from an expansion slot with the PC or ECH(PCI)BE-H2B/F2B/H4B/F4B powered.
Doing so may result in a malfunction, overheating, or fault.
Be sure to turn off the PC or ECH(PCI)BE-H2B/F2B/H4B/F4B and unplug their power cables before plugging or unplugging any expansion board.
- Do not plug or unplug the cable interconnecting the PC and the expansion chassis with the PC or ECH(PCI)BE-H2B/F2B/H4B/F4B powered.
- Do not turn on or off the power switch of the ECH(PCI)BE-H2B/F2B/H4B/F4B with the PC powered. Doing so may result in a malfunction.
- The total current consumption by the boards installed in the expansion slots in the ECH(PCI)BE-H2B/F2B/H4B/F4B must not exceed the maximum power capacity of its power supply.
Failure to supply ample power to expansion boards could result in a malfunction, overheating, or fault.
- The ECH(PCI)BE-H2B/F2B/H4B/F4B must always be used standing vertically.
Doing so may result in a malfunction, overheating, or fault.
- The external supply voltage or drive current must not exceed the rating.
- Do not connect any signal other than specified to the on-board connector.
Doing so may result in a malfunction, overheating, fault, or damage.
- If a specific expansion slot is recommended for a board, plug the board into that slot. Failure to do so may result in a malfunction, overheating, fault, or damage.
- When plugging or unplugging the power cable, be sure to hold it by the plug itself.
- Since the expansion chassis is a precision device, do not store or use it where it is subject to shock or vibration. Also avoid any place where the chassis is exposed to direct sunlight, extremely high humidity, or much dust.
- Do not use or store the chassis where it is exposed to any chemical either directly or as vapor in the air.
- The chassis has ventilating slits to prevent it from overheating. Avoid using the chassis with the ventilating slits blocked or in an ill-ventilated place.
- Do not use the chassis near equipment generating a strong magnetic field or noise.
Doing so may result in a malfunction, overheating, fault, or damage in the chassis, your PC, or both.
- It is very dangerous to use the chassis with water, liquid, or metal (conductive) chips left inside. Be careful not to let such foreign matters in the chassis.

- The specifications of this product are subject to change without notice for enhancement or quality improvement.
Even when using the product continuously, be sure to read the manual and understand the contents.
 - Do not modify this product.
CONTEC will bear no responsibility for any problems, etc., resulting from modifying the product.
 - Regardless of the foregoing statements, CONTEC is not liable for any damages whatsoever (including damages for loss of business profits) arising out of the use of or inability to use this CONTEC product or the information contained herein.
-

Environment

Use this product in the following environment. If used in an unauthorized environment, the chassis may overheat, malfunction, or cause a failure.

Operating temperature

0 - 50°C

Humidity

20 - 80%RH (No condensation)

Corrosive gases

None

Floating dust particles

Not to be excessive

Inspection

Inspect the product periodically as follows to use it safely.

- Ventilating slits must neither be blocked nor have dust or foreign matters adhering.

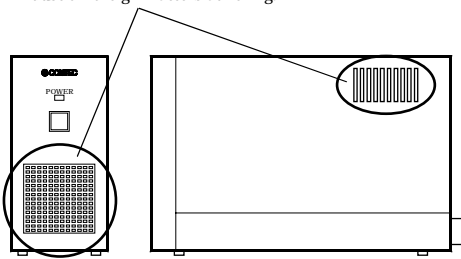

The illustration above is of the ECH(PCI)BE-H2B but the check points are the same as with the ECH(PCI)BE-F2B/H4B/F4B.

Storage

When storing this product, keep it in its original packing form.

- (1) Wrap it in the packing material, then put it in the box.
- (2) Store the package at room temperature at a place free from direct sunlight, moisture, shock, vibration, magnetism, and static electricity.

Disposal

When disposing of the product, follow the disposal procedures stipulated under the relevant laws and municipal ordinances.

2. Setup

This chapter explains how to set up the chassis.

Refer to the user's manual for the expansion adapter EAD(PCI)BE, EAD(LPCI)BE or EAD(CB)BE as required.

What is Setup?

Setup means a series of steps to take before the product can be used.

Taking the following steps in this chapter sets up the ECH(PCI)BE-H2B/F2B/H4B/F4B.

Step 1 Preparation

Step 2 Installing the Expansion Board

Step 3 Connecting the Cable

Step 4 Installing the expansion adapter board

Step 5 Setup and Check

If setup fails to be performed correctly, refer to "Setup Troubleshooting".

Step 1 Preparation

Configuration image



The photo is of the EAD(CB)BE+ECH(PCI)BE-H2B.

Figure 2.1. Configuration image

Items to be prepared

- PC
- Expansion adapter
Expansion adapter board...(a),
Connection Cable ...(b)
- Expansion chassis
Chassis [ECH(PCI)BE- H2B/F2B/H4B/F4B] ...(c), AC adapter...(d), Power cable ...(e)
- PCI board to be installed

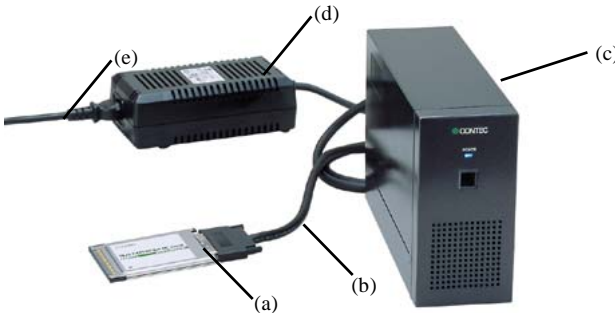

The photo is of the EAD(CB)BE+ECH(PCI)BE-H2B but the check points are the same as with the ECH(PCI)BE-F2B/H4B/F4B.

Names of major parts

ECH(PCI)BE-H2B/F2B

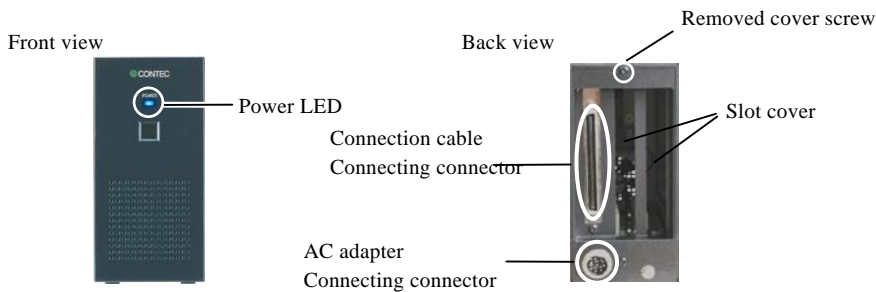

Figure 2.2. Names of major parts < ECH(PCI)BE-H2B/F2B >

ECH(PCI)BE-H4B/F4B

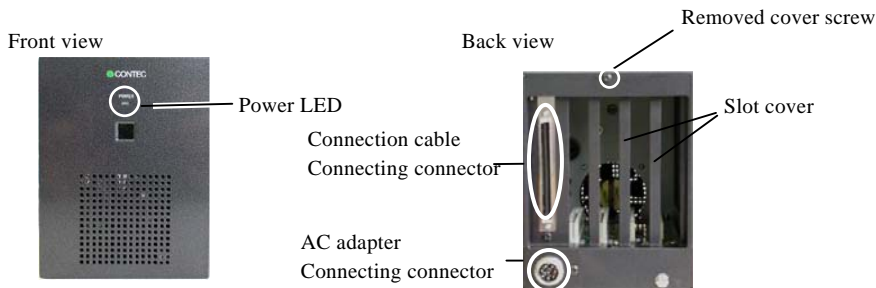

Figure 2.3. Names of major parts < ECH(PCI)BE-H4B/F4B >

Step 2 Installing the Expansion Board



CAUTION

Before installing an expansion board on the ECH(PCI)BE-H2B/F2B/H4B/F4B, be sure to turn off your PC or ECH(PCI)BE-H2B/F2B/H4B/F4B and unplug the power cables from wall outlets.

Follow the procedure below to install the expansion board on the ECH(PCI)BE-H2B/F2B/H4B/F4B.

- (1) Unplug the AC adapter and Connection Cable from the ECH(PCI)BE-H2B/F2B/H4B/F4B.
- (2) Remove one screw from the top of the rear panel, then remove the chassis cover by sliding it to the rear side (in the order of arrows 1 and 2).

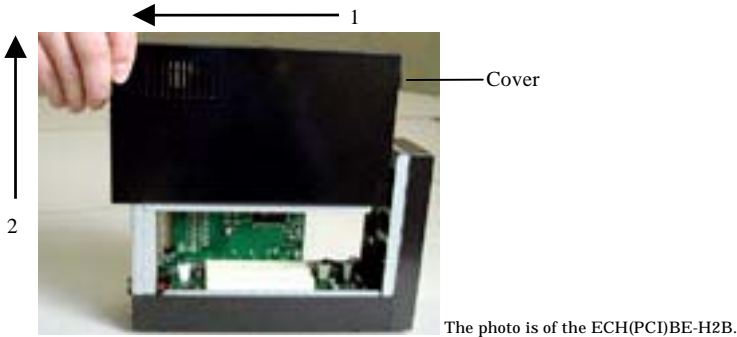

Figure 2.4. Installing the Expansion Board

- (3) Plug the expansion board into a PCI slot and fasten the bracket with the attached screw. Apply slot covers to unused slots and fasten them with screws.
- (4) Put the chassis cover back in place and fasten it with the removed screws.

Step 3 Connecting the Cable

Connecting the connection cable to the Expansion Adapter

Refer to the user's manual for the expansion adapter EAD(PCI)BE, EAD(LPCI)BE, EAD(CB)BE, or EAD-BE1-LPE to connect its connection cable to the expansion adapter.

Connecting the connection cable to the ECH(PCI)BE-H2B/F2B/H4B/F4B

Connect the 96-pin connector at the other end of the connection cable [CB-BF96, CB-CB68/96]] to the interface connector of the ECH(PCI)BE-H2B/F2B/H4B/F4B.

The interface connector is the leftmost connector on the rear panel of the expansion chassis.

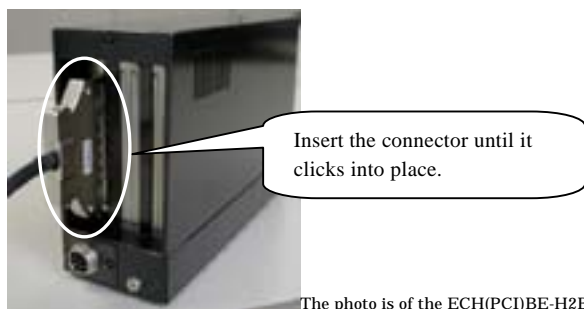

Figure 2.5. Connecting the connection cable to the ECH(PCI)BE-H2B/F2B/H4B/F4B



CAUTION

Do not plug the connection cable into any other connector as doing so can cause a fault.

Connecting the AC Adapter

- (1) Connect the AC adapter to the ECH(PCI)BE-H2B/F2B/H4B/F4B and turn the AC adapter's thumb screw to lock the AC adapter cable.

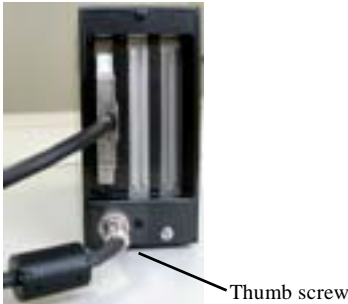

The photo is of the ECH(PCI)BE-H2B.

Figure 2.6. Connecting the AC Adapter

- (2) Plug the power cable into the AC adapter.
- (3) Plug the power cable into a wall outlet.

CAUTION

- Do not connect the AC adapter to the ECH(PCI)BE-H2B/F2B/H4B/F4B after plugging the AC adapter power cable into the wall outlet, or the expansion chassis may cause a fault. Connect the AC adapter to the ECH(PCI)BE-H2B/F2B/H4B/F4B first, then plug the power cable into the wall outlet.
 - Do not connect any adapter other than the attached AC one to the ECH(PCI)BE-H2B/F2B/H4B/F4B.
-

Step 4 Installing the expansion adapter board

Refer to the user's manual for the expansion adapter EAD(PCI)BE, EAD(LPCI)BE, EAD(CB)BE, or EAD-BE1-LPE to install the expansion bus adapter on the PC.

Step 5 Setup and Check

Starting the system

The ECH(PCI)BE-H2B/F2B/H4B/F4B is turned on and off in sync with the PC's power supply. When the PC detects the expansion adapter, the ECH(PCI)BE-H2B/F2B/H4B/F4B is turned on.

Turning on the system

- (1) Plug the power plug of the ECH(PCI)BE-H2B/F2B/H4B/F4B into a wall outlet.
You do not need to press the POWER switch on the front panel (*1).
- (2) The power supply of a PC is turned ON.
- (3) As soon as the expansion adapter is recognized by the PC, the ECH(PCI)BE-H2B/F2B/H4B/F4B is turned on automatically.
- (4) Make sure that the POWER LED on the ECH(PCI)BE-H2B/F2B/H4B/F4B is on.

Turning off the system

- (1) The power supply of a PC is turned OFF.
- (2) The ECH(PCI)BE-H2B/F2B/H4B/F4B is turned off in synchronization with the PC's power supply.

*1 Pressing the POWER switch on the front panel of the ECH(PCI)BE-H2B/F2B/H4B/F4B turns on the ECH(PCI)BE-H2B/F2B/H4B/F4B or puts it to sleep. Use the switch, for example, to turn on only the ECH(PCI)BE-H2B/F2B/H4B/F4B.



CAUTION

Do not turn on or off the ECH(PCI)BE-H2B/F2B/H4B/F4B with the PC main unit powered. Doing so cancels the detection of the bus adapter. When turning the ECH(PCI)BE-H2B/F2B/H4B/F4B on back, restart the PC main unit.

Setting up the hardware in Windows

At startup of Windows, the PCI-to-PCI Bridge used by the ECH(PCI)BE-H2B/F2B/H4B/F4B are detected in sequence and identified automatically by the Windows standard driver.

After that, the PCI boards installed on the ECH(PCI)BE-H2B/F2B/H4B/F4B are detected in sequence.

For setting up and checking the boards used on the expansion chassis, refer to their respective manuals.

Checking the hardware in Windows

You can use Device Manager to check whether the ECH(PCI)BE-H2B/F2B/H4B/F4B has been identified in Windows. Device Manager shows “PCI standard PCI-to-PCI bridge” and “Intel 21152 PCI to PCI bridge” under “System devices”.

Make sure that two entries of “PCI standard PCI-to-PCI bridge” and two entries of “Intel 21152 PCI to PCI bridge” are listed.

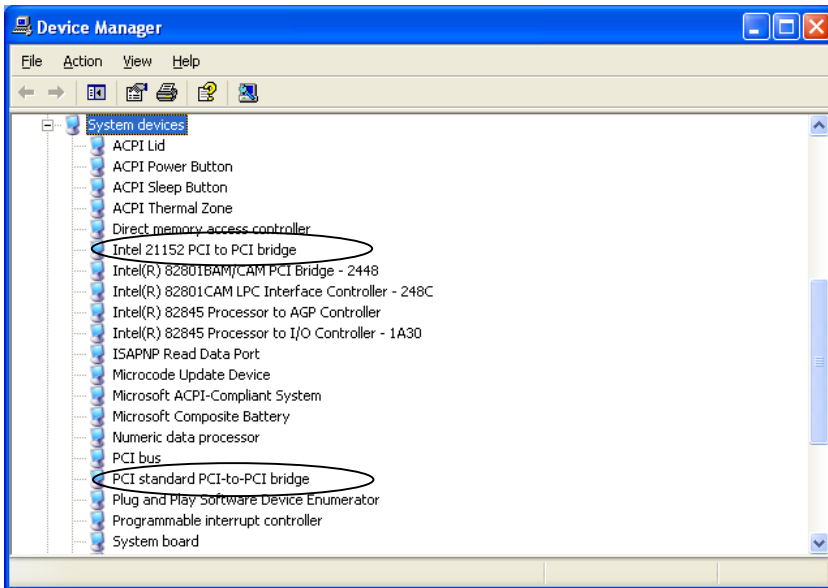

Figure 2.7. Sample screen shot of Device Manager

⚠ CAUTION

The expansion chassis does not depend on the OS in use.

Setup Troubleshooting

Please confirm followings when the ECH(PCI)BE-H2B/F2B/H4B/F4B does not work.

Symptoms and Actions

The chassis won't be turned on.

- a. Make sure that the power cable has been connected correctly.
- b. Make sure that the AC adapter has been connected correctly.
- c. Make sure that the power supplies of the PC or the ECH(PCI)BE-H2B/F2B/H4B/F4B are on.
- d. Make sure that you have followed the procedure in Chapter 2.
- e. Even though the chassis is still not turned on, check whether it is turned on with no board installed. If the chassis is turned on with no board installed, check the total current consumption by the installed boards. The total current consumption must not exceed the power capacity of the ECH(PCI)BE-H2B/F2B/H4B/F4B.

No PCI board on the ECH(PCI)BE-H2B/F2B/H4B/F4B is detected.

- f. Make sure that the expansion adapter has been installed correctly.
- g. Make sure that the connection cable has been installed correctly. When connecting the connection cable to the main chassis, insert the connector until it clicks into place.
- h. Make sure that the POWER LED on the ECH(PCI)BE-H2B/F2B/H4B/F4B is turned on.

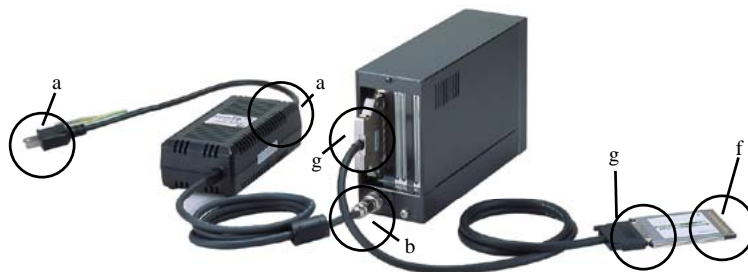

The photo is of the EAD(CB)BE+ECH(PCI)BE-H2B but the check points are the same as with the ECH(PCI)BE-F2B/H4B/F4B.

3. About Hardware

Hardware specification

Table 3.1. Specification < ECH(PCI)BE-H2B/F2B/H4B/F4B >

Item	ECH(PCI)BE-H2B	ECH(PCI)BE-F2B	ECH(PCI)BE-H4B	ECH(PCI)BE-F4B								
Compatible bus	PCI Local Bus Specification Rev2.3 (+5V type)											
Address space	32-bit memory address, I/O address											
Interrupt level	INTA - INTD											
Bus operating clock	33MHz (Max.)											
Number of user-available slots	2 slots (short size)	2 slots (long size)	4 slots (short size)	4 slots (long size)								
Acceptable board sizes (mm)	176.5(L) x 107(H)	313.8(L) x 107(H)	176.5(L) x 107(H)	313.8(L) x 107(H)								
Power supply												
Expansion slot supplied power (The output current must not exceed the value on the right.)	<table border="0"> <tr> <td>-5VDC</td> <td>7A (Max.) *2</td> </tr> <tr> <td>+3.3VDC</td> <td>3A (Max.) *2</td> </tr> <tr> <td>+12VDC</td> <td>1.5A (Max.)</td> </tr> <tr> <td>-12VDC</td> <td>0.3A (Max.)</td> </tr> </table>				-5VDC	7A (Max.) *2	+3.3VDC	3A (Max.) *2	+12VDC	1.5A (Max.)	-12VDC	0.3A (Max.)
-5VDC	7A (Max.) *2											
+3.3VDC	3A (Max.) *2											
+12VDC	1.5A (Max.)											
-12VDC	0.3A (Max.)											
Maximum total power capacity	60W											
AC input line voltage *1	100 - 240VAC											
AC line frequency	47 - 63Hz											
AC power input current	2A(90VAC)											
Outside dimensions (mm)	71.0(W) x 144.0(H) x 222.0(L) (without rubber feet)	71.0(W) x 144.0(H) x 360.0(L) (without rubber feet)	112.0(W) x 144.0(H) x 222.0(L) (without rubber feet)	112.0(W) x 144.0(H) x 360.0(L) (without rubber feet)								
Weight	1.2 kg	1.6 kg	1.5 kg	2.0 kg								
Outside dimensions of AC adapter (mm)	85(W) x 50(H) x 155(L)											
Cable length of AC adapter	1.2m											
AC cable	1.8m with 2P ground											
Weight of AC adapter	0.9 kg											

*1: AC input line voltage range: 90 - 264VAC

*2: The sum of +5VDC and +3.3VDC must not exceed 35W.

Outside dimensions of acceptable board (Max.)

< ECH(PCI)BE-H2B/H4B >

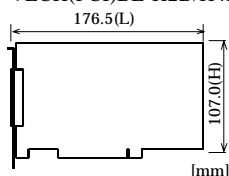

< ECH(PCI)BE-F2B/F4B >

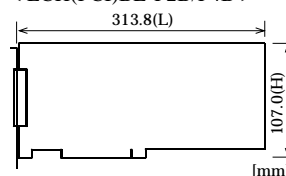

Table 3.2. Environmental specification

Item	Specification
Operating temperature	0 - 50°C
Operating humidity	20 - 80%RH(No condensation)
Storage temperature	0 - 60°C
Storage humidity	10 - 90%RH(No condensation)
Floating dust particles	Not to be excessive
Corrosive gases	None

⚠ CAUTION

The power supply and cooling fan in the ECH(PCI)BE-H2B/F2B/H4B/F4B are consumables, requiring replacement after use for a certain period of time. Although each of the parts should be replaced after use for the following period of time in principle, the life may be shortened depending on the operating environment. Keep in mind that the lives of the parts may be extremely shortened if they are used where it is either exposed to must dirt, metal chips or particles, or dust or affected by oil or corrosive gas.

- Power supply : About 5 years (in an office environment kept at a temperature of 25°C and a humidity of 60%)
 - Fan : About 5 years (in an office environment kept at a temperature of 25°C and a humidity of 60%)
-

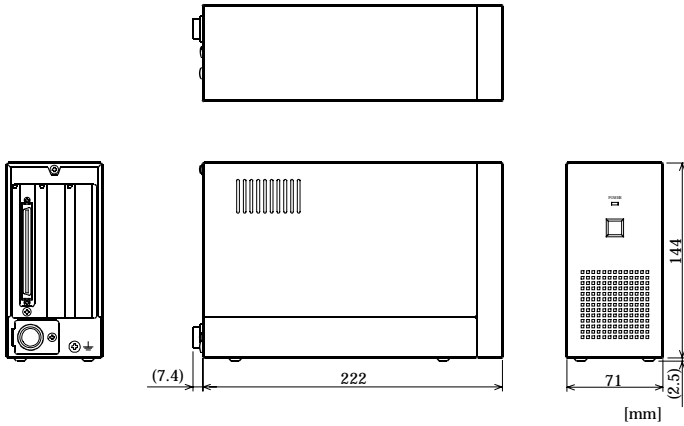

Figure 3.1. Outside Dimensions < ECH(PCI)BE-H2B >



Figure 3.2. Outside Dimensions < ECH(PCI)BE-F2B >

⚠ CAUTION

- When using this chassis, keep it at least 20mm away from any object such as the wall for cooling purposes.

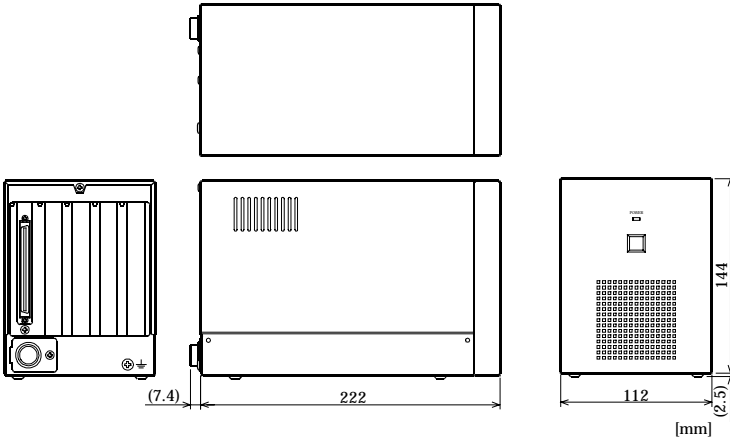

Figure 3.3. Outside Dimensions < ECH(PCI)BE-H4B >

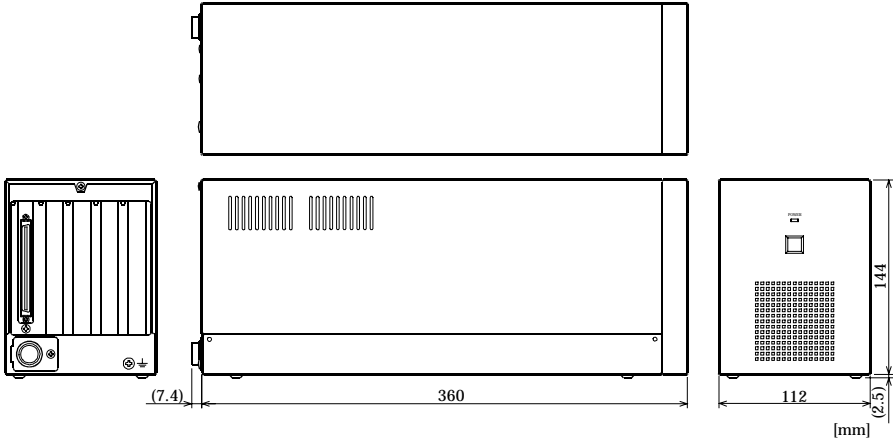

Figure 3.4. Outside Dimensions < ECH(PCI)BE-F4B >

⚠ CAUTION

- When using this chassis, keep it at least 20mm away from any object such as the wall for cooling purposes.
-

ECH(PCI)BE-H2B
ECH(PCI)BE-F2B
ECH(PCI)BE-H4B
ECH(PCI)BE-F4B
User's Manual

CONTEC CO., LTD.

December 2005 Edition

3-9-31, Himesato, Nishiyodogawa-ku, Osaka 555-0025, Japan

Japanese <http://www.contec.co.jp/>

English <http://www.contec.com/>

Chinese <http://www.contec.com.cn/>

No part of this document may be copied or reproduced in any form by any means without prior written consent of CONTEC CO., LTD. [12212005]

[10272003]

Management No. A-46-801

[12212005_rev4]

Parts No. LYDB131