

PC-HELPER

PCI Bus Expansion Chassis

Short x 4Slots

**ECH(PCI)SF-H4A**

Short x 7Slots

**ECH(PCI)SF-H7A**

Long x 7Slots

**ECH(PCI)SF-F7A**

Short x 13Slots

**ECH(PCI)SF-H13A**

Long x 13Slots

**ECH(PCI)SF-F13A**

User's Manual

CONTEC CO.,LTD.

---

# Check Your Package

---

Thank you for purchasing the CONTEC product.

The product consists of the items listed below.

Check, with the following list, that your package is complete. If you discover damaged or missing items, contact your retailer

## Product Configuration List

- Expansion chassis(One of the following) ...1  
[ECH(PCI)SF-H4A, ECH(PCI)SF-H7A,  
ECH(PCI)SF-F7A, ECH(PCI)SF-H13A  
ECH(PCI)SF-F13A]
- Power cable ...1
- Slot cover(One of the following)  
ECH(PCI)SF-H4A ...4,  
ECH(PCI)SF-H7A/F7A ...7,  
ECH(PCI)SF-H13A/F13A ...13
- Board fixed screw(One of the following)  
ECH(PCI)SF-H4A ...4,  
ECH(PCI)SF-H7A/F7A ...7,  
ECH(PCI)SF-H13A/F13A ...13
- Bracket fixed screw for rack-mounted  
(One of the following)  
ECH(PCI)SF-H4A/H7A/H13A ...4,  
ECH(PCI)SF-F7A/F13A ...6
- Rubber feet ...4
- User's Manual (this booklet)...1
- Bracket for rack-mounted ...2

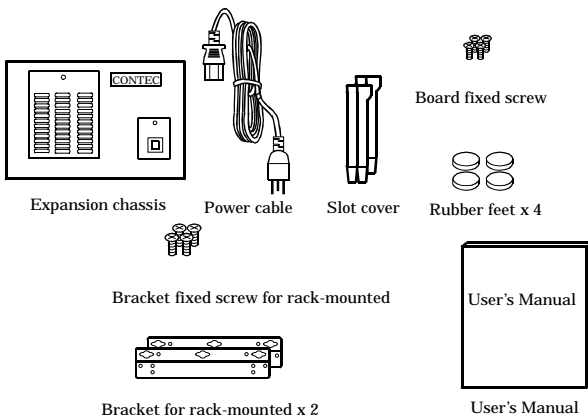

---

# Copyright

Copyright 2004 CONTEC CO., LTD. ALL RIGHTS RESERVED.

No part of this document may be copied or reproduced in any form by any means without prior written consent of CONTEC CO., LTD.

CONTEC CO., LTD. makes no commitment to update or keep current the information contained in this document. The information in this document is subject to change without notice.

All relevant issues have been considered in the preparation of this document. Should you notice an omission or any questionable item in this document, please feel free to notify CONTEC CO., LTD.

Regardless of the foregoing statement, CONTEC assumes no responsibility for any errors that may appear in this document or for results obtained by the user as a result of using this product.

# Trademarks

MS, Microsoft, Windows and Windows NT are trademarks of Microsoft Corporation. Other brand and product names are trademarks of their respective holder.

---

# Table of Contents

Check Your Package.....	i
Copyright .....	ii
Trademarks .....	ii
Table of Contents.....	iii

<b>1. BEFORE USING THE PRODUCT</b>	<b>1</b>
------------------------------------	----------

About the Chassis .....	1
Features .....	1
Expansion adapter (Option).....	1
Connection cable (Option).....	1
Combinations of Expansion Adapters and Expansion Chassis.....	2
Restrictions .....	3
Customer Support .....	4
Web Site.....	4
Limited Three-Years Warranty .....	4
How to Obtain Service .....	4
Liability.....	4
Safety Precautions .....	5
Safety Information .....	5
Handling Precautions.....	5
Environment.....	7
Inspection.....	7
Storage .....	7
Disposal .....	7

<b>2. SETUP</b>	<b>9</b>
-----------------	----------

What is Setup? .....	9
Step 1 Preparation.....	9
Items to be prepared.....	10
Names of major parts.....	11
Step 2 Installing the Expansion Board .....	13
Step 3 Connecting the Connection Cable.....	14
Connecting the connection cable to the Expansion Adapter.....	14
Connecting the connection cable to the ECH(PCI)SF-H4A/H7A/F7A/H13A/F13A.....	14
Plugging the Power Cable .....	15
Step 4 Installing the expansion adapter board.....	15
Step 5 Setup and Check .....	16
Starting the system.....	16
Setting up the hardware in Windows.....	17
Checking the hardware in Windows.....	17
Attaching Rack Mount Brackets .....	18
Setup Troubleshooting.....	19
Symptoms and Actions .....	19

---

### 3. ABOUT HARDWARE

21

Hardware specification .....	21
Outside Dimensions .....	24

# 1. Before Using the Product

This chapter provides information you should know before using the product.

## About the Chassis

The ECH(PCI)SF-H4A/H7A/F7A/H13A/F13A is an expansion chassis that adds PCI bus expansion slots to a PC by being connected to the PC via an optional expansion adapter [EAD(LPCI)SF] or [EAD(CB)SF].

The expansion adapter can connect the expansion chassis to the PC over a distance of up to 12m.

## Features

- Capable of adding PCI bus (5V/32-bit, 33MHz) slots.  
ECH(PCI)SF-H4A can add 4 slots.  
ECH(PCI)SF-H7A/F7A can add 7 slots.  
ECH(PCI)SF-H13A/F13A can add 13 slots.
- Accepting short-size PCI bus boards < ECH(PCI)SF-H4A/H7A/H13A >
- Accepting long-size PCI bus boards < ECH(PCI)SF-F7A/F13A >
- Power supply controllable in response to the turning on/off of the PC's power supply.
- Steel chassis suitable for use in fields.
- Built-in cooling fan.
- Rack-mountable with supplied brackets.

## Expansion adapter (Option)

PCI Bus Expansion Adapter for Low Profile PCI PC-Slot : EAD(LPCI)SF

PCI Bus Expansion Adapter for CardBus PC-Slot : EAD(CB)SF

Check the CONTEC's Web site for more information on these expansion adapters.

## Connection cable (Option)

Connection cables (12-meter, STP-category, 5e straight cables) are bundled with the expansion adapter EAD(CB)SF, EAD(LPCI)SF. The following options can also be available:

UTP-category, 5e straight cables (3m): TP-03 \*1\*2

UTP-category, 5e straight cables (5m): TP-05 \*1\*2

UTP-category, 5e straight cables (10m): TP-10 \*1\*2

\*1: A pair of cables are required for connection.

\*2: When used in an environment susceptible to extraneous noise, UTP cables may cause link connection. It is advisable to use STP cables available on the market.

## Combinations of Expansion Adapters and Expansion Chassis

The expansion adapters and expansion chassis can be used in the following combinations:

Expansion adapter	Expansion chassis ECH(PCI)SF								
	-H2B	-F2B	-H4B	-F4B	-H4A	-H7A	-F7A	-H13A	-F13A
EAD(CB)SF	O	O	O	O	O	x	x	x	x
EAD(LPCI)SF	O	O	O	O	O	O	O	O	O

### Expansion chassis



ECH(PCI)SF-H2B



ECH(PCI)SF-F2B



ECH(PCI)SF-H4B



ECH(PCI)SF-F4B



ECH(PCI)SF-H4A



ECH(PCI)SF-H7A



ECH(PCI)SF-F7A



ECH(PCI)SF-H13A



ECH(PCI)SF-F13A

### Expansion adapter



EAD(LPCI)SF



EAD(CB)SF

## Restrictions

ECH(PCI)SF-H4A/H7A/F7A/H13A/F13A has restrictions on the types of PCs and boards that can be used.

Be sure to check the following restrictions before use.

### < Restrictions of PC >

ECH(PCI)SF-H4A/H7A/F7A/H13A/F13A uses the switch fabric to extend the bus.

The PCI boards plugged in PCI slots in the ECH(PCI)SF-H4A/H7A/F7A/H13A/F13A are recognized if the switch fabric is recognized as the PCI-to-PCI bridge by the BIOS in the PC used. Ask the PC vendor for whether the BIOS recognizes the PCI-to-PCI bridge.

### < Restriction on power interlocking >

Power interlocking does not work well if the PCI bus slots on your PC do not conform to PCI Local Bus Specification Rev. 2.2. Ask the PC vendor for whether the PCI bus slots conform to the specification.

When power interlocking is not needed, the expansion chassis can be used without it by changing the setting of the expansion bus adapter in the chassis. For details on setting up, refer to Chapter2, "Setup".

### < Restrictions on transfer rate >

When the expansion chassis accommodates a board that performs high-speed transfer such as bus mastering, the overall transfer rate may be lower than that of PCI bus slots in the main unit of a desktop PC.

This is caused by bus extension by the PCI-to-PCI Bridge.

The transfer rate may vary with the system configuration and the type of the PC.

### < Restrictions of PCI board >

None of the following boards can be plugged into any expansion slot in the ECH(PCI)SF-H4A/H7A/F7A/H13A/F13A.

- Video display board (VGA board)
- Board to connect a PCI bus expansion chassis
- Board explicitly stated not to be used with the PCI-to-PCI Bridge

Some boards, even PCI-compliant ones, may not work depending on their specifications



## Customer Support

CONTEC provides the following support services for you to use CONTEC products more efficiently and comfortably.

### Web Site

Japanese <http://www.contec.co.jp/>  
English <http://www.contec.com/>  
Chinese <http://www.contec.com.cn/>

Latest product information

CONTEC provides up-to-date information on products.

CONTEC also provides product manuals and various technical documents in the PDF.

Free download

You can download updated driver software and differential files as well as sample programs available in several languages.

Note! For product information

Contact your retailer if you have any technical question about a CONTEC product or need its price, delivery time, or estimate information.

## Limited Three-Years Warranty

CONTEC products are warranted by CONTEC CO., LTD. to be free from defects in material and workmanship for up to three years from the date of purchase by the original purchaser.

Repair will be free of charge only when this device is returned freight prepaid with a copy of the original invoice and a Return Merchandise Authorization to the distributor or the CONTEC group office, from which it was purchased.

This warranty is not applicable for scratches or normal wear, but only for the electronic circuitry and original products. The warranty is not applicable if the device has been tampered with or damaged through abuse, mistreatment, neglect, or unreasonable use, or if the original invoice is not included, in which case repairs will be considered beyond the warranty policy.

## How to Obtain Service

For replacement or repair, return the device freight prepaid, with a copy of the original invoice. Please obtain a Return Merchandise Authorization number (RMA) from the CONTEC group office where you purchased before returning any product.

\* No product will be accepted by CONTEC group without the RMA number.

## Liability



The obligation of the warrantor is solely to repair or replace the product. In no event will the warrantor be liable for any incidental or consequential damages due to such defect or consequences that arise from inexperienced usage, misuse, or malfunction of this device.

# Safety Precautions

Understand the following definitions and precautions to use the product safely.

## Safety Information

This document provides safety information using the following symbols to prevent accidents resulting in injury or death and the destruction of equipment and resources. Understand the meanings of these labels to operate the equipment safely.

 DANGER	DANGER indicates an imminently hazardous situation which, if not avoided, will result in death or serious injury.
 WARNING	WARNING indicates a potentially hazardous situation which, if not avoided, could result in death or serious injury.
 CAUTION	CAUTION indicates a potentially hazardous situation which, if not avoided, may result in minor or moderate injury or in property damage.

## Handling Precautions

### DANGER

Do not use the product where it is exposed to flammable or corrosive gas. Doing so may result in an explosion, fire, electric shock, or failure.

### CAUTION

- Do not plug or unplug any board into or from an expansion slot with the PC or ECH(PCI)SF-H4A/H7A/F7A/H13A/F13A powered. Doing so may result in a malfunction, overheating, or fault. Be sure to turn off the PC and ECH(PCI)SF-H4A/H7A/F7A/H13A/F13A and unplug their power cables before plugging or unplugging any expansion board.
- Do not plug or unplug the cable interconnecting the PC and the expansion chassis with the PC or ECH(PCI)SF-H4A/H7A/F7A/H13A/F13A powered.
- Do not turn on or off the power switch of the ECH(PCI)SF-H4A/H7A/F7A/H13A/F13A with the PC powered. Doing so may result in a malfunction.
- The total current consumption by the boards installed in the expansion slots in the ECH(PCI)SF-H4A/H7A/F7A/H13A/F13A must not exceed the maximum power capacity of its power supply.  
Failure to supply ample power to expansion boards could result in a malfunction, overheating, or fault.
- The external supply voltage or drive current must not exceed the rating.
- Do not connect any signal other than specified to the on-board connector.  
Doing so may result in a malfunction, overheating, fault, or damage.
- If a specific expansion slot is recommended for a board, plug the board into that slot. Failure to do so may result in a malfunction, overheating, fault, or damage.
- When plugging or unplugging the power cable, be sure to hold it by the plug itself.

## 1. Before Using the Product

---

- Since the expansion chassis is a precision device, do not store or use it where it is subject to shock or vibration. Also avoid any place where the chassis is exposed to direct sunlight, extremely high humidity, or much dust.
  - Do not use or store the chassis where it is exposed to any chemical either directly or as vapor in the air.
  - The chassis has ventilating slits to prevent it from overheating. Avoid using the chassis with the ventilating slits blocked or in an ill-ventilated place.
  - Do not use the chassis near equipment generating a strong magnetic field or noise. Doing so may result in a malfunction, overheating, fault, or damage in the chassis, your PC, or both.
  - It is very dangerous to use the chassis with water, liquid, or metal (conductive) chips left inside. Be careful not to let such foreign matters in the chassis.
  - The specifications of this product are subject to change without notice for enhancement or quality improvement.
  - Even when using the product continuously, be sure to read the manual and understand the contents.
  - Do not modify this product.  
CONTEC will bear no responsibility for any problems, etc., resulting from modifying the product.
  - Regardless of the foregoing statements, CONTEC is not liable for any damages whatsoever (including damages for loss of business profits) arising out of the use of or inability to use this CONTEC product or the information contained herein.
-

## Environment

Use this product in the following environment. If used in an unauthorized environment, the chassis may overheat, malfunction, or cause a failure.

Operating temperature

0 - 50°C

Humidity

20 - 80%RH (No condensation)

Corrosive gases

None

Floating dust particles

Not to be excessive

## Inspection

Inspect the product periodically as follows to use it safely.

- Ventilating slits must neither be blocked nor have dust or foreign matters adhering.

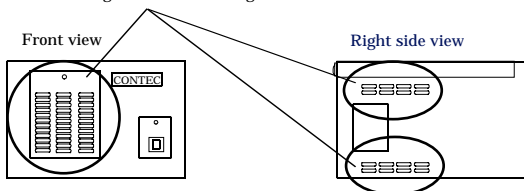

The illustration above is of the ECH(PCI)SF-H4A but the check points are the same as with the ECH(PCI)SF-F7A/F13A.

## Storage

When storing this product, keep it in its original packing form.

- (1) Put the chassis in the storage bag.
- (2) Wrap it in the packing material, then put it in the box.
- (3) Store the package at room temperature at a place free from direct sunlight, moisture, shock, vibration, magnetism, and static electricity.

## Disposal

When disposing of the product, follow the disposal procedures stipulated under the relevant laws and municipal ordinances.



## 2. Setup

This chapter explains how to set up the chassis.

Refer to the user's manual for the expansion adapter EAD(LPCI)SF, EAD(CB)SF as required.

### What is Setup?

Setup means a series of steps to take before the product can be used.

Taking the following steps in this chapter sets up the ECH(PCI)SF-H4A/H7A/F7A/H13A/F13A.

#### Step 1 Preparation

#### Step 2 Installing the Expansion Board

#### Step 3 Connecting the Connection Cable

#### Step 4 Installing the expansion adapter board

#### Step 5 Setup and Check

If setup fails to be performed correctly, refer to "Setup Troubleshooting".

### Step 1 Preparation

Configuration image

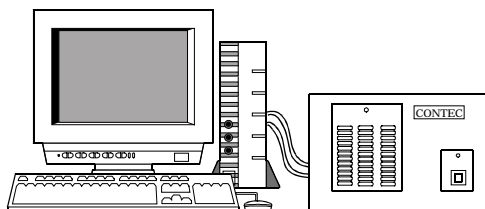

The photo is of the EAD(LPCI)SF+ECH(PCI)SF-H4A.

**Figure 2.1. Configuration image**

## Items to be prepared

- PC
- Expansion adapter  
(The expansion adapter consists of a PC card / board to be plugged on a PC and connection cables.)  
PC card / board to be plugged on a PC ... (a),  
Connection Cable ... (b)  
(The connection cables can be used by UTP- or STP-category 5e straight cables of up to 12m in length.)
- Expansion chassis (This product)  
Chassis [ECH(PCI)SF-H4A/H7A/F7A/H13A/F13A] ... (c), Power cable
- PCI board to be installed

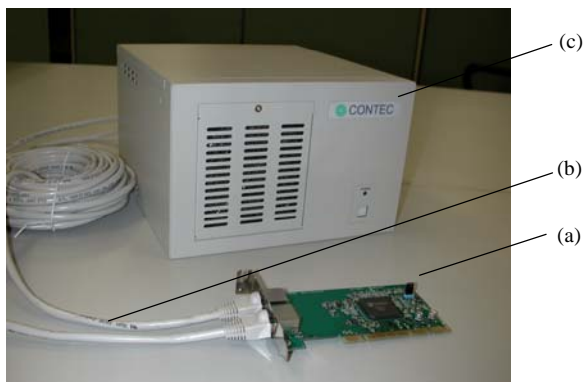

The photo is of the EAD(LPCI)SF+ECH(PCI)SF-H4A but the check points are the same as with the ECH(PCI)SF-H7A/F7A/H13A/F13A.

### CAUTION

When used in an environment susceptible to extraneous noise, UTP cables may cause link connection. It is advisable to use STP cables available on the market.

---

## Names of major parts

ECH(PCI)SF-H4A

Front view

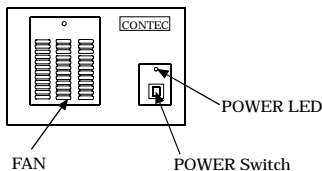

Back view

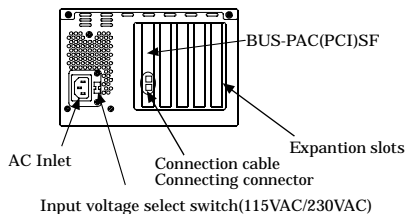

**Figure 2.2. Names of major parts < ECH(PCI)SF-H4A >**

ECH(PCI)SF-H7A/F7A

Front view

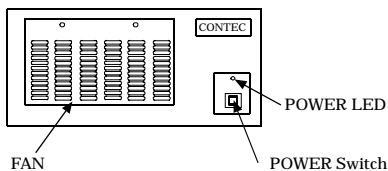

Back view

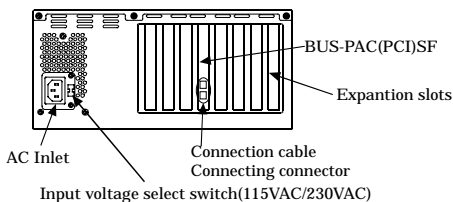

**Figure 2.3. Names of major parts < ECH(PCI)SF-H7A/F7A >**

ECH(PCI)SF-H13A/F13A

Front view

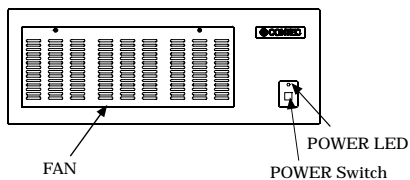

Back view

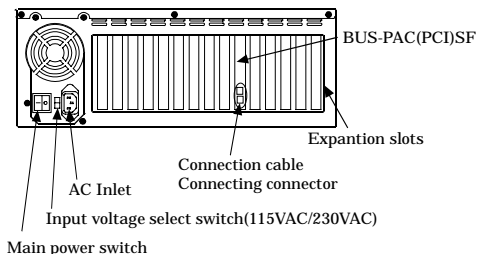

**Figure 2.4. Names of major parts < ECH(PCI)SF-H13A/F13A >**



BUS-PAC(PCI)SF

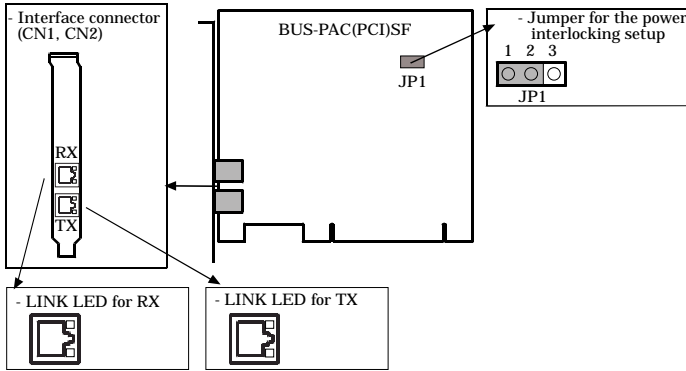

Figure 2.5. Names of major parts < BUS-PAC(PCI)SF >

Power interlocking of the expansion chassis

Power interlocking does not work well if the PCI bus slots on your PC do not conform to PCI Local Bus Specification Rev. 2.2. In that case, move the JP1's jumper plug from the 2-3 position to the 1-2 position.

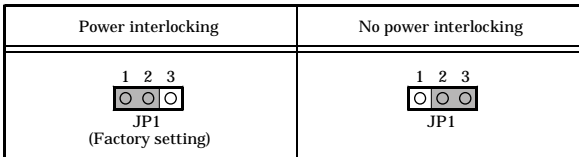

Figure 2.6. Setup for the expansion chassis power interlocking

LINK LED

The LINK LEDs show whether the switch fabric device is working normally.

Both of the TX and RX LEDs remain on when the device is working normally. If they are blinking or off, see "Setup Troubleshooting."

**⚠ CAUTION**

The PC may malfunction if link disconnection occurs with the LINK LED blinking or off.

## Step 2 Installing the Expansion Board

### ⚠ CAUTION

Before installing an expansion board on the ECH(PCI)SF-H4A/H7A/F7A/H13A/F13A, be sure to turn off your PC and the ECH(PCI)SF-H4A/H7A/F7A/H13A/F13A and unplug the power cables from wall outlets.

Follow the procedure below to install the expansion board on the ECH(PCI)SF-H4A/H7A/F7A/H13A/F13A.

- (1) Unplug the power cable and connection cable from the ECH(PCI)SF-H4A/H7A/F7A/H13A/F13A.
- (2) Remove two screws(ECH(PCI)SF-F7A/F13A is three screws) from the top of the rear panel, then remove the chassis cover by sliding it to the rear side (in the order of arrows 1 and 2).

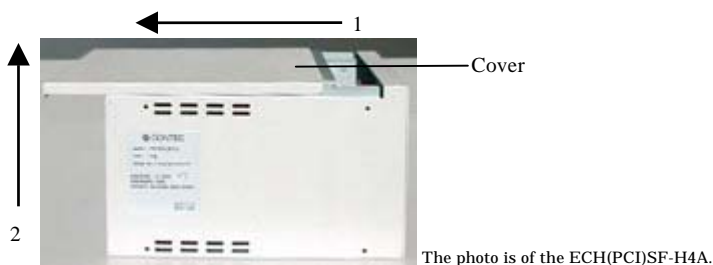

**Figure 2.7. Installing the Expansion Board**

- (3) Plug the expansion board into a PCI slot and fasten the bracket with the attached screw. Apply slot covers to unused slots and fasten them with screws.
- (4) Put the chassis cover back in place and fasten it with the removed screws.

## Step 3 Connecting the Connection Cable

### Connecting the connection cable to the Expansion Adapter

Refer to the user's manual for the expansion adapter EAD(LPCI)SF, EAD(CB)SF to connect its connection cable to the expansion adapter.

### Connecting the connection cable to

#### the ECH(PCI)SF-H4A/H7A/F7A/H13A/F13A

Connect the RJ-45 connector of connection cable to that of ECH(PCI)SF-H4A/H7A/F7A/H13A/F13A.

Connect the ECH(PCI)SF-H4A/H7A/F7A/H13A/F13A to the expansion adapter EAD(LPCI)SF, EAD(CB)SF installed on the PC as shown below.

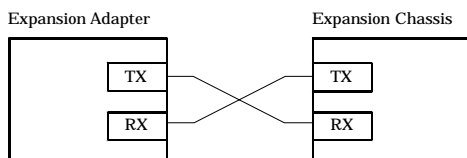

**Figure 2.8. Connecting the expansion bus adapter**

See “Names of Major Parts” in this chapter to confirm the location of the interface connector.

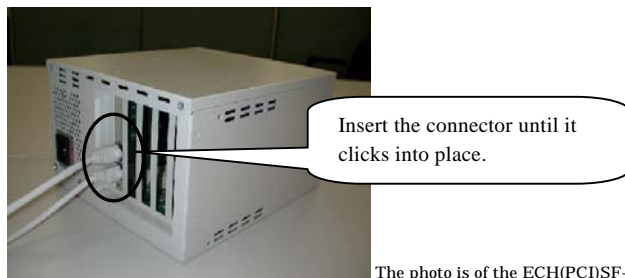

The photo is of the ECH(PCI)SF-H4A.

**Figure 2.9. Connecting the Connection cable to the ECH(PCI)SF-H4A/H7A/F7A/H13A/F13A**

### CAUTION

- Do not connect the connection cable to the other connector. Doing so may result in a malfunction.
- When used in an environment susceptible to extraneous noise, UTP cables may cause link connection. It is advisable to use STP cables available on the market.
- The PC may malfunction if link disconnection occurs with the LINK LED blinking or off.

## Plugging the Power Cable

- (1) Plug the power cable into the ECH(PCI)SF-H4A/H7A/F7A/H13A/F13A.



The photo is of the ECH(PCI)SF-H4A.

**Figure 2.10. Plugging the power cable into the ECH(PCI)SF-H4A/H7A/F7A/H13A/F13A**

- (2) Plug the power cable into a wall outlet.

## Step 4 Installing the expansion adapter board

Refer to the user's manual for the expansion adapter EAD(LPCI)SF, EAD(CB)SF to install the expansion bus adapter on the PC.

## Step 5 Setup and Check

### Starting the system

The ECH(PCI)SF-H4A/H7A/F7A/H13A/F13A is turned on and off in sync with the PC's power supply. When the PC detects the expansion adapter, the ECH(PCI)SF-H4A/H7A/F7A/H13A/F13A is turned on.

#### Turning on the system

- (1) Plug the power plug of the ECH(PCI)SF-H4A/H7A/F7A/H13A/F13A into a wall outlet.  
You do not need to press the POWER switch on the front panel (\*1).
- (2) The power supply of a PC is turned ON.
- (3) As soon as the expansion adapter is recognized by the PC, the ECH(PCI)SF-H4A/H7A/F7A/H13A/F13A is turned on automatically.
- (4) Make sure that the POWER LED on the ECH(PCI)SF-H4A/H7A/F7A/H13A/F13A and the LINK LED on the RJ-45 connector is on.

#### Turning off the system

- (1) The power supply of a PC is turned OFF.
- (2) The ECH(PCI)SF-H4A/H7A/F7A/H13A/F13A is turned off in synchronization with the PC's power supply.

\*1 Pressing the POWER switch on the front panel of the ECH(PCI)SF-H4A/H7A/F7A/H13A/F13A turns on the ECH(PCI)SF-H4A/H7A/F7A/H13A/F13A or puts it to sleep. Use the switch, for example, to turn on only the ECH(PCI)SF-H4A/H7A/F7A/H13A/F13A.



### CAUTION

---

- Do not turn on or off the ECH(PCI)SF-H4A/H7A/F7A/H13A/F13A with the PC main unit powered. Doing so cancels the detection of the bus adapter. When turning the expansion chassis on back, restart the PC main unit.
  - If you turn on the PC after turning it off, keep a time interval of at least 10 seconds in between. If the power OFF-to-ON interval is too short, the expansion chassis may fail to be turned on.
-

## Setting up the hardware in Windows

Upon startup of Windows, the switch fabric devices used by the expansion adapter and the expansion chassis are detected as a PCI-to-PCI Bridge and Other PCI Bridge Device in sequence. PCI-to-PCI Bridges are recognized automatically by a Windows standard driver but Other PCI Bridge Devices are not supported by any Windows standard driver. Therefore the Other PCI Bridge Device requires an INF file before it can be recognized correctly.

(Note that the expansion chassis works normally even without the INF file.)

After that, the PCI boards installed on the ECH(PCI)SF-H4A/H7A/F7A/H13A/F13A are detected in sequence.

For setting up and checking the boards used on the expansion chassis, refer to their respective manuals.

## Checking the hardware in Windows

You can use Device Manager to check whether the ECH(PCI)SF-H4A/H7A/F7A/H13A/F13A has been identified in Windows. Device Manager shows “PCI standard PCI-to-PCI bridge” under “System devices”.

The ECH(PCI)SF-H4A/H7A/F7A/H13A/F13A in use can be identified with the number of “PCI standard PCI-to-PCI bridge” entries. If the number of “PCI standard PCI-to-PCI bridge” is not sufficient, or the boards on the expansion chassis are not recognized, restart Windows. They may not be recognized without restarting.

Two entries: ECH(PCI)SF-H4A

Three entries: ECH(PCI)SF-H7A/F7A

Five entries: ECH(PCI)SF-H13A/F13A

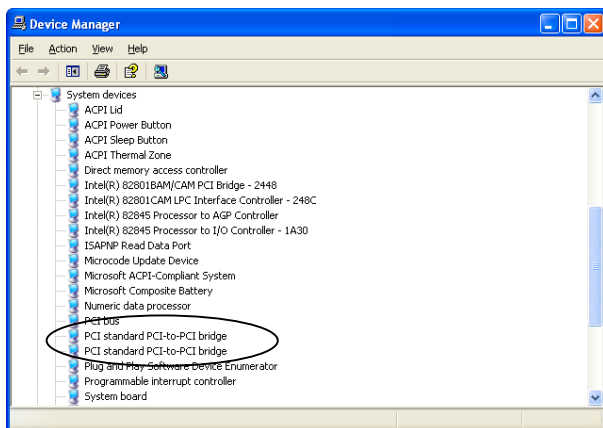

Figure 2.11. Sample screen shot of Device Manager (ECH(PCI)SF-H4A)



### CAUTION

The expansion chassis does not depend on the OS in use.

## Attaching Rack Mount Brackets

The ECH(PCI)SF-H4A/H7A/F7A/H13A/F13A can be rack mounted using the attached brackets. The brackets can be used in two ways as illustrated below. Rack-mount the ECH(PCI)SF-H4A/H7A/F7A/H13A/F13A using the brackets by the appropriate method suitable for the operating environment.

< Horizontally placed >

< Vertically placed >

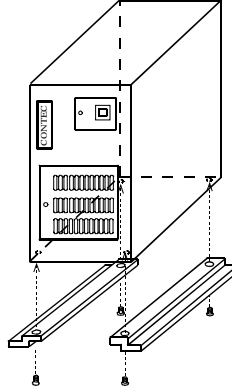
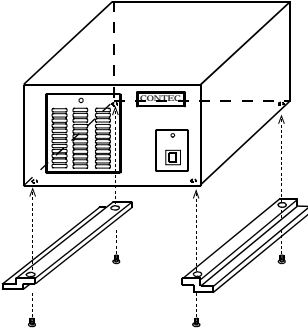

The photo is of the ECH(PCI)SF-H4A but the check points are the same as with the ECH(PCI)SF-H7A/F7A/H13A/F13A.

**Figure 2.12. Attaching the Rack Mount Brackets**

# Setup Troubleshooting

Please confirm followings when the ECH(PCI)SF-H4A/H7A/F7A/H13A/F13A does not work.

## Symptoms and Actions

The chassis won't be turned on.

- a. Make sure that the power cable has been connected correctly.
- b. Make sure that the power supplies of the PC and the ECH(PCI)SF-H4A/H7A/F7A/H13A/F13A are on.
- c. Make sure that you have followed the procedure in Chapter 2.
- d. Even though the chassis is still not turned on, check whether it is turned on with no board installed. If the chassis is turned on with no board installed, check the total current consumption by the installed boards. The total current consumption must not exceed the power capacity of the ECH(PCI)SF-H4A/H7A/F7A/H13A/F13A.

No PCI board on the ECH(PCI)SF-H4A/H7A/F7A/H13A/F13A is detected.

- e. Restart Windows. They may be recognized after restarting.
- f. Make sure that the expansion adapter board has been installed correctly.
- g. Make sure that the JP1 of expansion adapter board has been installed correctly.
- h. Make sure that the connection cable has been installed correctly. When connecting the connection cable to the main chassis, insert the connector until it clicks into place.

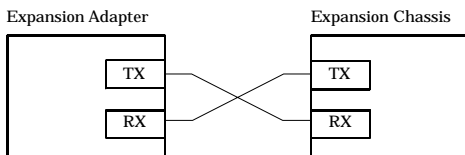

- i. Make sure that the POWER LED on the ECH(PCI)SF-H4A/H7A/F7A/H13A/F13A is turned on. Make sure that the LED (LINK) built in the RJ-45 connector is on. When used in an environment susceptible to extraneous noise, UTP cables may cause link connection. It is advisable to use STP cables available on the market.

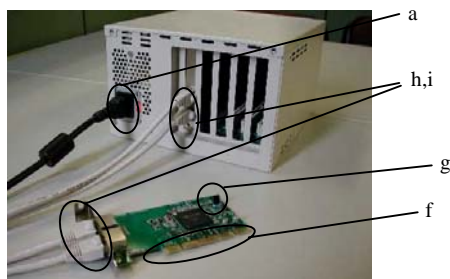

The photo is of the EAD(LPCI)SF+ECH(PCI)SF-H4A but the check points are the same as with the ECH(PCI)SF-H7A/F7A/H13A/F13A.





## 3. About Hardware

### Hardware specification

**Table 3.1. Specification < ECH(PCI)SF-H4A/H7A/F7A >**

Item	ECH(PCI)SF-H4A	ECH(PCI)SF-H7A	ECH(PCI)SF-F7A
Compatible bus	PCI Local Bus Specification Rev2.2 (+5V type)		
Address space	32-bit memory address, I/O address		
Interrupt level	INTA - INTD		
Bus operating clock	33MHz (Max.)		
Number of user-available slots	4 slots (short size)	7 slots (short size)	7 slots (long size)
Acceptable board sizes (mm)	176.5(L) x 107(H)	176.5(L) x 107(H)	313.8(L) x 107(H)
Power supply			
Expansion slot supplied power (The output current must not exceed the value on the right.)	-5VDC 11.3A (Max.) +3.3VDC 6A (Max.) +12VDC 3A (Max.) -12VDC 0.7A (Max.)		
Maximum total power capacity	130W *2		
AC input line voltage *1	115/230VAC (selecting switch)		
AC line frequency	50 - 60Hz		
AC power input current	3A(115VAC)/1.5A(230VAC)		
Outside dimensions of the AC adapter (mm)	210.0(W) x 138.0(H) x 235.0(L) (No fittings)	300.0(W) x 138.0(H) x 255.0(L) (No fittings)	300.0(W) x 138.0(H) x 373.2(L) (No fittings)
Weight	3.5 kg	5.0 kg	6.0 kg
AC cable	2.5m 3P		

\*1: AC input line voltage range: 90 - 132VAC and 180 - 250VAC

\*2: Condition with CE marking: 130W at 40°C.

Outside dimensions of acceptable board (Max.)

&lt; ECH(PCI)SF-H4A/H7A &gt;

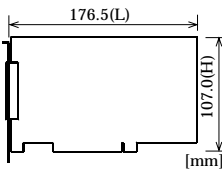

&lt; ECH(PCI)SF-F7A &gt;

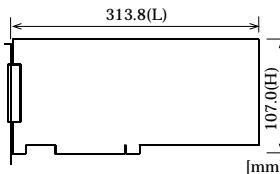

**Table 3.2. Specification < ECH(PCI)SF-H13A/ F13A >**

Item	ECH(PCI)SF-H13A	ECH(PCI)SF-F13A
Compatible bus	PCI Local Bus Specification Rev2.2 (+5V type)	
Address space	32-bit memory address, I/O address	
Interrupt level	INTA - INTD	
Bus operating clock	33MHz (Max.)	
Number of user-available slots	13 slots (short size)	13 slots (long size)
Acceptable board sizes (mm)	176.5(L) x 107(H)	313.8(L) x 107(H)
Power supply		
Expansion slot supplied power (The output current must not exceed the value on the right.)	-5VDC 18A (Max.) *2 +3.3VDC 15A (Max.) *2 +12VDC 9A (Max.) -12VDC 0.8A (Max.)	
Maximum total power capacity	0 - 30°C: 230W 30 - 40°C: 205W 40 - 50°C: 175W *3	
AC input line voltage *1	115/230VAC (selecting switch)	
AC line frequency	50 - 60Hz	
AC power input current	6A(115VAC)/4A(230VAC)	
Outside dimensions of the AC adapter (mm)	424.0(W) x 156.0(H) x 255.0(L) (No fittings)	424.0(W) x 156.0(H) x 373.2(L) (No fittings)
Weight	7.5 kg	9.0 kg
AC cable	2.5m 3P	

\*1: AC input line voltage range: 90 - 132VAC and 180 - 250VAC

\*2: The sum of +5VDC and +3.3VDC must not exceed 90W.

\*3: Condition with CE marking: 175W at 50°C.

Outside dimensions of acceptable board (Max.)

< ECH(PCI)SF-H13A >

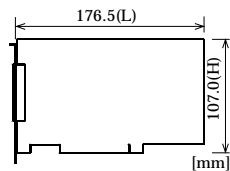

< ECH(PCI)SF-F13A >

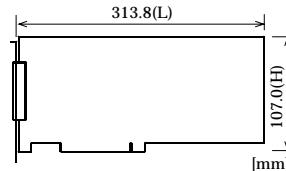

**Table 3.2. Environmental specification**

Item	Specification
Operating temperature	0 - 50°C
Operating humidity	20 - 80%RH(No condensation)
Storage temperature	0 - 60°C
Storage humidity	10 - 90%RH(No condensation)
Floating dust particles	Not to be excessive
Corrosive gases	None

**CAUTION**

The power supply and cooling fan in the ECH(PCI)SF-H4A/H7A/F7A/H13A/F13A are consumables, requiring replacement after use for a certain period of time. Although each of the parts should be replaced after use for the following period of time in principle, the life may be shortened depending on the operating environment. Keep in mind that the lives of the parts may be extremely shortened if they are used where it is either exposed to must dirt, metal chips or particles, or dust or affected by oil or corrosive gas.

- Power supply : About 5 years  
(in an office environment kept at a temperature of 25°C and a humidity of 60%)
- Fan : About 5 years  
(in an office environment kept at a temperature of 25°C and a humidity of 60%)
- Fan Filter : About 1 year  
(in an office environment kept at a temperature of 25°C and a humidity of 60%)

# Outside Dimensions

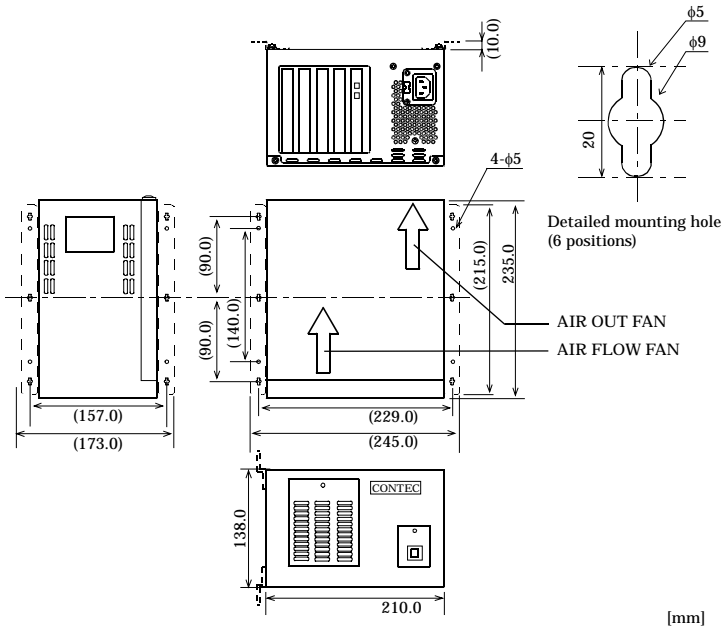

The parenthesized dimensions are measured with the rack mount brackets attached.

**Figure 3.1. Outside Dimensions < ECH(PCI)SF-H4A >**

## ⚠ CAUTION

- When using this chassis, keep it at least 20mm away from any object such as the wall for cooling purposes.
- Attaching rubber feet to the chassis makes it 3.6mm taller.

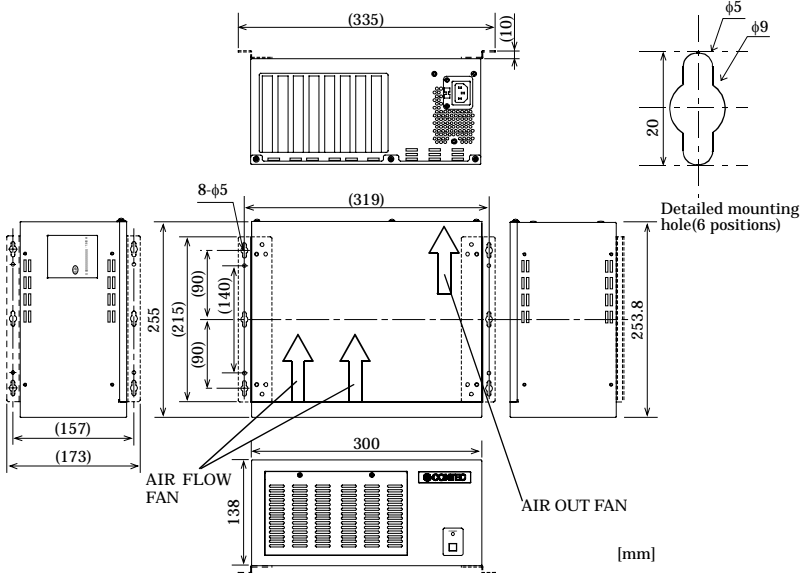

The parenthesized dimensions are measured with the rack mount brackets attached.

**Figure 3.2. Outside Dimensions < ECH(PCI)SF-H7A >**



### CAUTION

- When using this chassis, keep it at least 20mm away from any object such as the wall for cooling purposes.
- Attaching rubber feet to the chassis makes it 7mm taller.

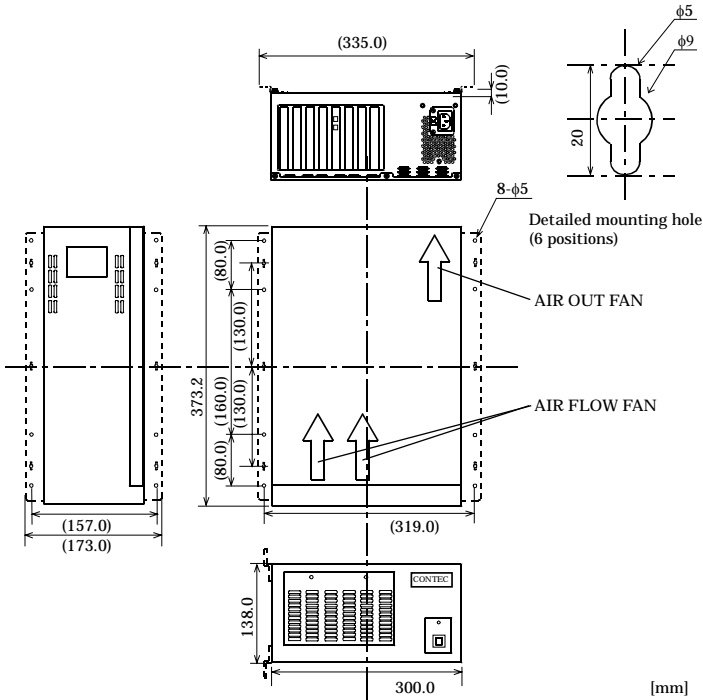

The parenthesized dimensions are measured with the rack mount brackets attached.

**Figure 3.3. Outside Dimensions < ECH(PCI)SF-F7A >**



**CAUTION**

- When using this chassis, keep it at least 20mm away from any object such as the wall for cooling purposes.
- Attaching rubber feet to the chassis makes it 7mm taller.

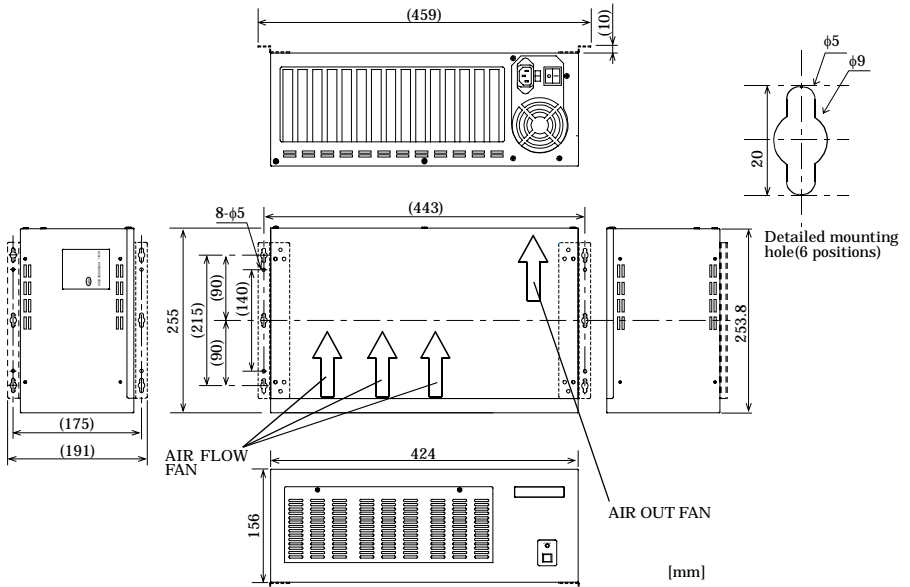

The parenthesized dimensions are measured with the rack mount brackets attached.

**Figure 3.4. Outside Dimensions < ECH(PCI)SF-H13A >**



**CAUTION**

- When using this chassis, keep it at least 20mm away from any object such as the wall for cooling purposes.
- Attaching rubber feet to the chassis makes it 8mm taller.



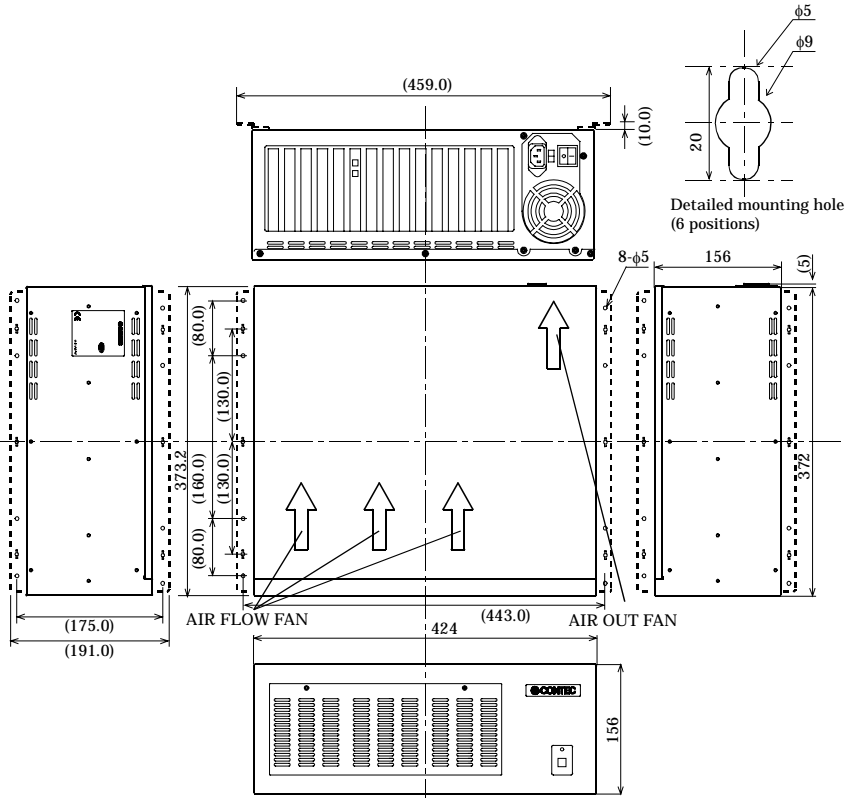

The parenthesized dimensions are measured with the rack mount brackets attached.

[mm]

**Figure 3.5. Outside Dimensions < ECH(PCI)SF-F13A >**

**⚠ CAUTION**

- When using this chassis, keep it at least 20mm away from any object such as the wall for cooling purposes.
- Attaching rubber feet to the chassis makes it 8mm taller.

ECH(PCI)SF-H4A  
ECH(PCI)SF-H7A  
ECH(PCI)SF-F7A  
ECH(PCI)SF-H13A  
ECH(PCI)SF-F13A  
User's Manual

---

CONTEC CO., LTD.

February 2006 Edition

3-9-31, Himesato, Nishiyodogawa-ku, Osaka 555-0025, Japan

Japanese <http://www.contec.co.jp/>

English <http://www.contec.com/>

Chinese <http://www.contec.com.cn/>

No part of this document may be copied or reproduced in any form by any means without prior written consent of CONTEC CO., LTD. [02152006]

---

[04212004]

Management No. A-46-848

[02152006\_rev3]

Parts No. LYDK291