

F&eIT Series

GPIB-Ethernet Media Converter

**RP-GPIB(FIT)GY**

User's Manual

CONTEC CO.,LTD.

---

# Check Your Package

---

Thank you for purchasing the CONTEC product.

The product consists of the items listed below.

Check, with the following list, that your package is complete. If you discover damaged or missing items, contact your retailer.

## Product Configuration List < RP-GPIB(FIT)GY >

- Module [RP-GPIB(FIT)GY] ...1
- First Step Guide ... 1
- CD-ROM [F&eIT Series Setup Disk] \*1...1
- AC Adapter ...1
- Rubber feet ...4
- Piece of Velcro ...2 set

\*1 The CD-ROM contains various software and User's Manual (this manual)

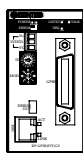

Module

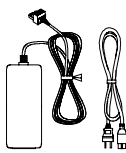

AC adapter



Rubber feet x 4



Piece of Velcro x 2

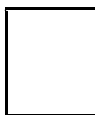

First step guide



CD-ROM

[F&eIT Series Setup Disk]

---

# Copyright

Copyright 2003 CONTEC CO., LTD. ALL RIGHTS RESERVED.

No part of this document may be copied or reproduced in any form by any means without prior written consent of CONTEC CO., LTD.

CONTEC CO., LTD. makes no commitment to update or keep current the information contained in this document.

The information in this document is subject to change without notice.

All relevant issues have been considered in the preparation of this document. Should you notice an omission or any questionable item in this document, please feel free to notify CONTEC CO., LTD.

Regardless of the foregoing statement, CONTEC assumes no responsibility for any errors that may appear in this document nor for results obtained by the user as a result of using this product.

# Trademarks

F&eIT is a registered trademark or trademark of CONTEC CO., LTD. Other company and product names that are referred to in this manual are generally trademarks or registered trade trademark.

---

# Table of Contents

Check Your Package.....	i
Copyright .....	ii
Trademarks .....	ii
Table of Contents.....	iii

<b>1. BEFORE USING THE PRODUCT</b>	<b>1</b>
------------------------------------	----------

About the Board.....	1
Features .....	1
Support Software .....	1
Customer Support .....	2
Web Site.....	2
Limited One-Year Warranty.....	2
How to Obtain Service .....	2
Liability.....	2
Safety Precautions .....	3
Safety Information.....	3
Precautions Related to Service .....	3
Handling Precautions.....	3
Environment.....	5
Inspection.....	5
Storage .....	5
Disposal .....	5

<b>2. MODULE NOMENCLATURE AND SETTINGS</b>	<b>7</b>
--	----------

Nomenclature of Module Components.....	7
LED Indicator .....	7
MODE Switch.....	8
ID Switch.....	8
Input-Output Interface .....	9

<b>3. OPERATION OUTLINE</b>	<b>11</b>
-----------------------------	-----------

Remote control mode.....	11
--------------------------	----

<b>4. INSTALLATION AND CONNECTION</b>	<b>13</b>
---------------------------------------	-----------

Installation Method.....	13
Mounting on a DIN Rail .....	13
Table Top Installation.....	15
Another form of installation .....	15
Connection .....	16
Cable Connection.....	16
Connection of a Power Supply .....	18

---

<b>5.</b>	<b>SETUP</b>	<b>19</b>
-----------	--------------	-----------

Setup Procedures.....	19
Utility Software.....	20
Starting of Utility Software .....	20
Node Registration .....	22
Configuration .....	23
File Management .....	25
Status .....	26
Installing the Driver for Windows.....	28
Correspondence OS .....	28
Installation .....	28
Accessing the Help File .....	28
Using Sample Programs.....	29

<b>6.</b>	<b>TROUBLESHOOTING</b>	<b>31</b>
-----------	------------------------	-----------

When Communication Fails .....	31
When the RP-GPIB(FIT)GY Will Not Start .....	31

<b>7.</b>	<b>SYSTEM REFERENCE</b>	<b>33</b>
-----------	-------------------------	-----------

Product Specifications .....	33
External Dimensions.....	35

# 1. Before Using the Product

This chapter provides information you should know before using the product.

## About the Board

This product is a media converter for converting between GPIB interface and Ethernet interfaces.

This product allows your Windows PC to remotely control a GPIB device conforming to the IEEE-488.1 or IEEE-488.2(GPIB) standard over a LAN.

Please read this manual carefully before performing system configuration such as setting switches or connecting to external devices.

## Features

- Capable of connecting an IEEE-488.1 or IEEE-488.2 compliant device to a wired LAN (Ethernet) within the maximum distance restricted by Ethernet.
- Supplied windows driver allowing a PC to control the connected GPIB device over the LAN.
- Utility software bundled to easily detect the device, load settings, update firmware, and display status information. (Supporting Windows Vista, XP, 2000, Me, 98SE, and 98 etc.)  
For details, read Help supplied on the CD-ROM.
- Rotary switch available to set an ID that determines and visibly indicate the device address (0 - 15). The device address can also be set with software within the range of 0 - 30.
- A series of LEDs including LISTEN, TALK, and SRQ allowing you to check the current GPIB communication status at a glance.
- Like other F&eIT series products, a 35mm DIN rail attachment is fitted to the module as a standard feature.

## Support Software

You should use CONTEC support software according to your purpose and development environment.

Win32 version of RP-GPIB(FIT) driver : **API-RPGPIB(W32)** (Bundled)

API-RPGPIB(W32) is the library software that provides the commands for RP-GPIB(FIT)GY in the form of Windows standard Win32 API functions (DLL). It makes it easy to create high-speed application software taking advantage of the CONTEC hardware using various programming languages that support Win32 API functions, such as Visual Basic and Visual C/C++.

< Operating environment >

OS	Windows Vista, XP, 2000, Me, 98SE, 98etc.. For details, read Help supplied on the CD-ROM.
Adaptation language	Visual C++, Visual Basic, etc..
Others	Each piece of library software requires 20 megabytes of free hard disk space.

# Customer Support

CONTEC provides the following support services for you to use CONTEC products more efficiently and comfortably.

## Web Site

Japanese <http://www.contec.co.jp/>  
English <http://www.contec.com/>  
Chinese <http://www.contec.com.cn/>

Latest product information

CONTEC provides up-to-date information on products.

CONTEC also provides product manuals and various technical documents in the PDF.

Free download

You can download updated driver software and differential files as well as sample programs available in several languages.

Note! For product information

Contact your retailer if you have any technical question about a CONTEC product or need its price, delivery time, or estimate information.

## Limited One-Year Warranty

CONTEC products are warranted by CONTEC CO., LTD. to be free from defects in material and workmanship for up to one year from the date of purchase by the original purchaser.

Repair will be free of charge only when this device is returned freight prepaid with a copy of the original invoice and a Return Merchandise Authorization to the distributor or the CONTEC group office, from which it was purchased.

This warranty is not applicable for scratches or normal wear, but only for the electronic circuitry and original boards. The warranty is not applicable if the device has been tampered with or damaged through abuse, mistreatment, neglect, or unreasonable use, or if the original invoice is not included, in which case repairs will be considered beyond the warranty policy.

## How to Obtain Service

For replacement or repair, return the device freight prepaid, with a copy of the original invoice. Please obtain a Return Merchandise Authorization Number (RMA) from the CONTEC group office where you purchased before returning any product.

\* No product will be accepted by CONTEC group without the RMA number.

## Liability

The obligation of the warrantor is solely to repair or replace the product. In no event will the warrantor be liable for any incidental or consequential damages due to such defect or consequences that arise from inexperienced usage, misuse, or malfunction of this device.

# Safety Precautions

Understand the following definitions and precautions to use the product safely.

## Safety Information

This document provides safety information using the following symbols to prevent accidents resulting in injury or death and the destruction of equipment and resources. Understand the meanings of these labels to operate the equipment safely.

⚠ DANGER	DANGER indicates an imminently hazardous situation which, if not avoided, will result in death or serious injury.
⚠ WARNING	WARNING indicates a potentially hazardous situation which, if not avoided, could result in death or serious injury.
⚠ CAUTION	CAUTION indicates a potentially hazardous situation which, if not avoided, may result in minor or moderate injury or in property damage.

## Precautions Related to Service

Clean the RP-GPIB(FIT)GY by wiping lightly with a soft cloth moistened with water or a cleaning solution.

Take care to avoid the use of benzene, thinners or other volatile solutions which may cause deformation or discoloration.

## Handling Precautions

### ⚠ CAUTION

- Do not modify the module. CONTEC will bear no responsibility for any problems, etc., resulting from modifying this module.
- Do not use or store the equipment in a hot or cold place, or in a place that is subject to severe temperature changes.
- Do not use or store the equipment in a place subject to direct sunlight or near a heating device, such as a stove.
- Do not use or store the equipment in a dusty or humid place.
- Do not use or store the product near equipment generating a strong magnetic field or radio waves.
- As this product contains precision electronic components, do not use or store in environments subject to shock or vibration.
- If you notice any strange odor or overheating, please unplug the power cord immediately.
- In the event of an abnormal condition or malfunction, please consult the dealer from whom the equipment was purchased.
- To avoid electric shock, please do not touch the system with a wet hand.
- Do not open the module casing. CONTEC will disclaim any responsibility for equipment whose casing has been opened.
- To prevent damage, please do not subject the unit to impact or bend it.



## 1. Before Using the Product

---

- To prevent contact malfunction, please do not touch the metallic pins on the external module connector.
  - The module contains switches that need to be properly set. Before using the module, please check its switch settings.
  - To avoid malfunction, please do not change the module switch settings in an unauthorized manner.
  - Do not modify the RP-GPIB(FIT)GY. CONTEC will bear no responsibility for any problems, etc., resulting from modifying this product.
  - Regardless of the foregoing statements, CONTEC is not liable for any damages whatsoever (including damages for loss of business profits) arising out of the use or inability to use this CONTEC product or the information contained herein.
- 

### FCC PART 15 Class A Notice

#### NOTE

This equipment has been tested and found to comply with the limits for a Class A digital device, pursuant to part 15 of the FCC Rules. These limits are designed to provide reasonable protection against harmful interference when the equipment is operated in commercial environment.

This equipment generates, uses, and can radiate radio frequency energy and, if not installed and used in accordance with the instruction manual, may cause harmful interference to radio communications. Operation of this equipment in a residential area is likely to cause harmful interference at his own expense.

#### WARNING TO USER

Change or modifications not expressly approved the manufacturer can void the user's authority to operate this equipment.

## Environment

Use this product in the following environment. If used in an unauthorized environment, the board may overheat, malfunction, or cause a failure.

Operating temperature

0 - 50°C

Operating humidity

10 - 90%RH (No condensation)

Corrosive gases

None

Floating dust particles

Not to be excessive

## Inspection

Inspect the product periodically as follows to use it safely.

- \* Check that the ventilation slit has no obstruction and has no dust or foreign matter adhering.

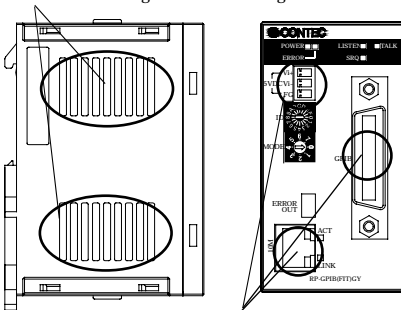

- \* Check that the bus corner of the module and its cable has been plugged correctly.

## Storage

When storing this product, keep it in its original packing form.

- (1) Put this product in the storage bag.
- (2) Wrap it in the packing material, then put it in the box.
- (3) Store the package at room temperature at a place free from direct sunlight, moisture, shock, vibration, magnetism, and static electricity.

## Disposal

When disposing of the product, follow the disposal procedures stipulated under the relevant laws and municipal ordinances.



## 2. Module Nomenclature and Settings

### Nomenclature of Module Components

Figure 2.1 shows the names of module components. In the figure, the indicated switch settings represent factory settings.

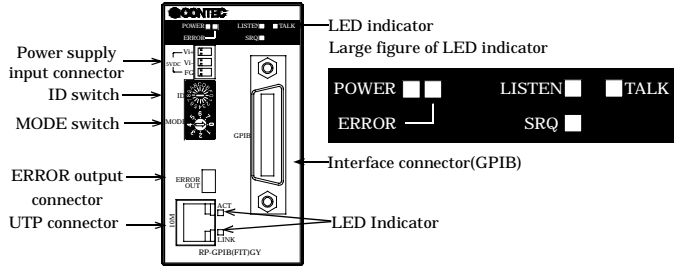

**Figure 2.1. Nomenclature of Module Components**

#### ⚠ CAUTION

Do not block the ventilation vents as this may result in damage or malfunction due to overheating.

## LED Indicator

**Table 2.1. LED Display**

LED Name	Status	Indicator
POWER	Flashing	Indicates that the module is being activated or an activation error has occurred.
	On	Indicates that the module is active.
LISTEN	On	Indicates that the module is receiving data.
TALK	On	Indicates that the module is sending data.
SRQ	On	Indicates that a service request has been generated.
ERROR	On	Indicates that a GPIB interface error has occurred.
ACT	On	Indicates that the module is sending LAN data or is not communicating.
	Flashing	Indicates that the module is receiving LAN data.
LINK	On	Indicates that the module has been connected to a LAN.

## MODE Switch

The operation mode is determined by the value to which the MODE switch is set upon activation of the RP-GPIB(FIT)GY.

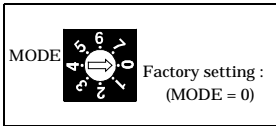

**Figure 2.2. Mode Switch**

**Table 2.2. Mode Switch**

MODE Switch value	Operating mode	Description
0	Remote control mode	Causes the module to operate in remote control mode.
2 - 5	Reserved	Not used.
6	Reset mode	Resets the RP-GPIB(FIT)GY settings to their factory settings. Upon activation of the RP-GPIB(FIT)GY, all the settings return to their factory settings. They will take effect the next time you will start the module. * Before restarting or shutting down, make sure that only the POWER LED is on (with all of the ERROR, LISTEN, TALK, SRQ LEDs off).
7	Firmware update mode	Select this mode to update the module's firmware. Usually, the firmware can be updated in any mode. If the firmware stops getting started normally, update it in this firmware update mode.

## ID Switch

The ID switch is used to set the device address of the RP-GRIB(FIT)GY.

Since the RP-GPIB(FIT)GY loads the value of the ID switch upon startup, set the ID switch before turning on the power.

The setting range is 0 - F (0 - 15).



**Figure 2.3. ID Switch**

You can also set the device address using a bundled utility instead of the ID switch. The device address can be changed temporarily with the bundled Windows driver.

# Input-Output Interface

**Table 2.3. Input-Output Interface**

Name	Function
GPIB connector	Connector to connect the GPIB interface
UTP Port	Port used for networking Connected in full-duplex/half-duplex mode at an automatically detected communication speed of 10 Mbps
ERROR-OUT	Output specification : Opto-coupler-insulated open-collector output Output rating : 30VDC(Max.), 10mA(Min.) Response time : 100μsec(Max.)
Power supply input connector	5VDC±5% Two-piece power input detachable connector equipped with FG pin Coming standard with horizontally accessible, screw-locked dedicated plug (MC1.5/3-ST-3.5 Phoenix Contact Compatible cables : AWG28-16)

GPIB connector

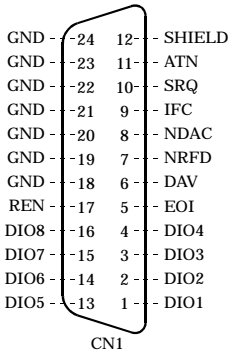
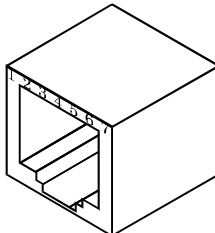

**Figure 2.4. GPIB connector Pin Assignments**

UTP connector

**Table 2.4. UTP Port Pin Assignments**

Pin No.	Signal
1	TD+
2	TD-
3	RD+
4	Not used
5	Not used
6	RD-
7	Not used
8	Not used



Error-Output connector

**Table 2.5. Error-Output**

Function	Output specification	Response to error detection
The detection circuit remains made. Upon detection of an error, the circuit is broken, turning the output on from off. (The output is normally on.)	Output specification : Opto-coupler-insulated open-collector output Output rating : 30VDC(Max.), 10mA(Min.) Response time : 100μsec(Max.)	The output is switched from on to off upon detection of a GPIB interface error.

Reference equivalent circuit

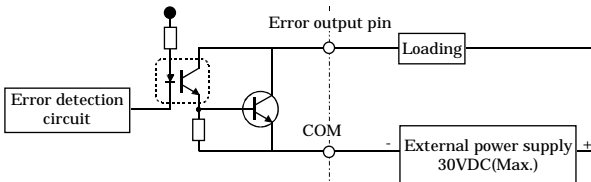

**Figure 2.5. Reference equivalent circuit**

Error-Output connector

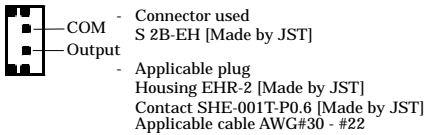

**Figure 2.6. Error-Output connector**

## 3. Operation Outline

### Remote control mode

With the remote control driver for Windows installed on your PC, you can operate the remote GPIB interfaced device connected to the RP-GPIB(FIT)GY over a LAN as if the device were placed by your side

When using an application on the PC to operate the GPIB device, specify the IP address of the RP-GPIB(FIT)GY to be remote-controlled.

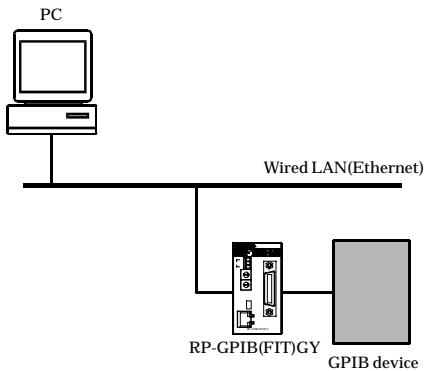

**Figure 3.1. Remote control mode**

#### ⚠ CAUTION

To avoid any adverse effects on other LAN devices, set the IP address, subnet mask, and other network parameters to appropriate values.





## 4. Installation and Connection

### Installation Method

#### Mounting on a DIN Rail

Mounting procedure

- (1) Pushing the fixing hook with a flat-blade screwdriver renders it into a lock-enabled condition (this operation should be done on all connected modules).

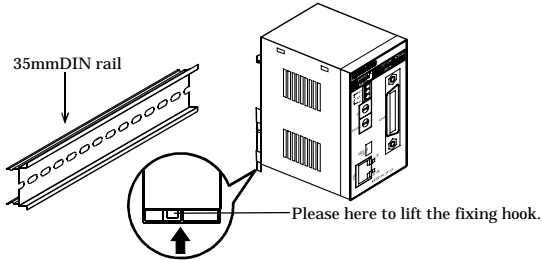

**Figure 4.1. Mounting on a DIN Rail < 1 / 3 >**

- (2) Hook the unit (an object consisting of a controller and a module) from the upper part of the DIN rail, and press the lower part of the unit onto the DIN rail.

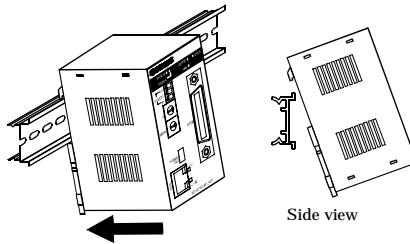

**Figure 4.1. Mounting on a DIN Rail < 2 / 3 >**

- (3) The fixing hook is automatically locked, and the module can be mounted in one-touch.

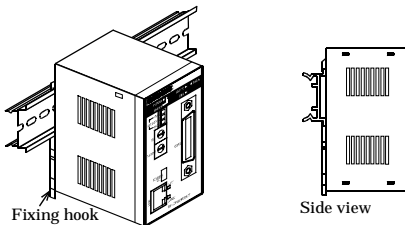

**Figure 4.1. Mounting on a DIN Rail < 3 / 3 >**

Removal procedure

- (1) Lower the fixing hook for the unit to unlock it (this operation should be performed on all connected modules).

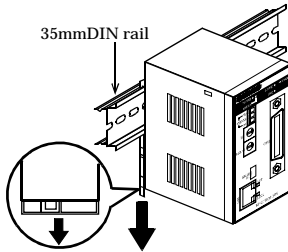

**Figure 4.2. Removing the Module from the DIN Rail <1 / 3 >**

- (2) With the fixing hook unlocked, pull the lower part of the unit toward you.

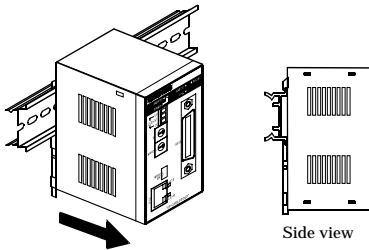

**Figure 4.2. Removing the Module from the DIN Rail <2 / 3 >**

- (3) By lifting the unit, you can easily remove it from the DIN rail.

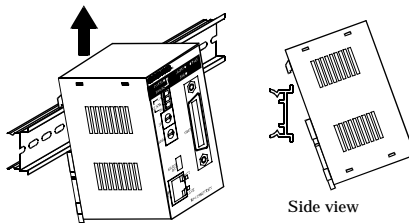

**Figure 4.2. Removing the Module from the DIN Rail <3 / 3 >**

## Table Top Installation

Use the rubber pads included with the unit.

To install on a table top, choose a sturdy, level surface with a well-ventilated space (approx. 5cm.) in all directions.



### CAUTION

---

Do not obstruct the ventilation slits. This can cause the temperature inside the product to rise and can damage the components inside.

---

## Another form of installation

You can attach it to the instrument by using the piece of Velcro with this product.

To install on a table top, choose a sturdy, level surface with a well-ventilated space (approx. 5cm.) in all directions.



### CAUTION

---

- Do not obstruct the ventilation slits. This can cause the temperature inside the product to rise and can damage the components inside.
  - The seal is strongly adhesive but its adhesion may not be enough depending on the material of the target. The Velcro tape can be removed when an excessive force is applied, for example, to the cable. In such cases, the RP-GPIB(FIT)GY may fall, possibly resulting mechanical damages or malfunctions. Use meticulous care not to let the module fall.
-

# Connection

## Cable Connection

### GPIB Cable Connection

The GPIB has restrictions on the number of devices connected and the cable length according to the standard.

- (1) The maximum number of interfaces (external devices) is 15, which can be connected to one system.
- (2) The maximum total length of cables that can be used to interconnect a group of devices in one bus system is “2 m x (the number of devices)” or 20 m, whichever is shorter. (JIS C1901-1987). Some examples are given below.

- **System with a total of two devices**

2 m x (Number of devices = 2) < 20 m. The maximum total length of cables for this system is therefore 4 m.

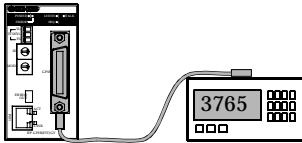

- **System with a total of three devices**

The maximum total length of cables for this system is therefore 6 m. The two cables used in the system must be [2 m + 4 m] or [2 m + 2 m] in length so that neither is longer than 4m.

- **System with a total of fifteen devices**

2 m x (Number of devices = 15) > 20 m. The maximum total length of cables for this system is therefore 20 m.

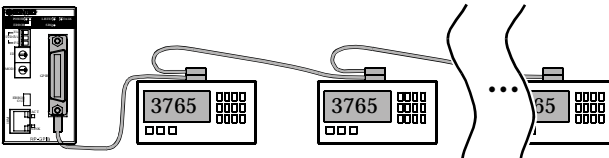

- (3) Unplug the cable from any device which is left off for some reason such as a fault.

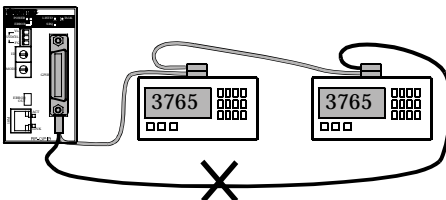

- (4) Unplug the cable from any device which is left off for some reason such as a fault.
- (5) When powering the measurement system, turn on the measuring instrument first and then on the PC.
- (6) Neither unplug/plug the cable nor turn on/off the device during communication. Doing so stops the operation or causes an error, resulting in trouble.
- (7) The talker and listener must be addressed to talk and to listen, respectively, by the controller before the talker can send messages to the listener.
- (8) After completing all the required cable connections, turn on the power to the RP-GPIB(FIT)GY.
- (9) Treat the GPIB cable carefully not to apply an excessive force to the GPIB connector of the RP-GPIB(FIT)GY.

#### UTP Cable Connection

Connect the UTP connector to the UTP cable.

<Cable Specifications>

Cables complying with the following specifications should be used:

Category 3, 4, 5 UTP cable

## Connection of a Power Supply

Connect the supplied AC adapter to the power input connector.

You can also connect a power supply unit (sold separately) (POW-AD13GY, POW-AD22GY, POW-AD25GY, POW-DD10GY, POW-DD42GY). To connect a power supply unit to the RP-GPIB(FIT)GY, connect the cable to the removable connector on the unit or module face.

(Applicable cables: AWG 28 - 16)

### ⚠ CAUTION

Because the power supply unit generates heat, a minimum spacing of 2.cm should be provided between the RP-GPIB(FIT)GY and any adjoining units, and care should be taken so that the ventilation holes are not covered.

<An appending AC adapter is used>

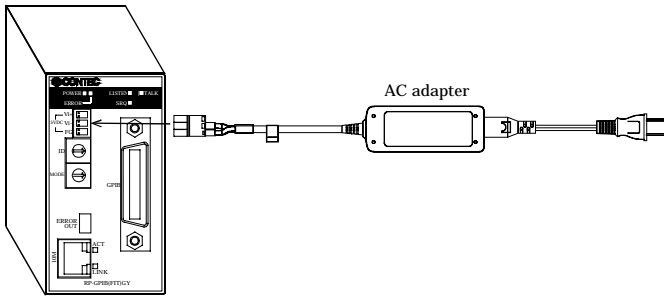

<An optional power supply unit is used>

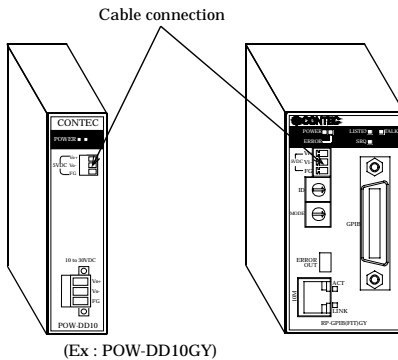

Figure 4.3. Connection of a Power Supply

## 5. Setup

### Setup Procedures

When installing the RP-GPIB(FIT)GY in a network, set the module's unique IP address different from any of the IP addresses of the other networked devices.

Use the bundled utility software to set the IP address.

Setting up the module

- (1) Set the MODE switch.  
Set the MODE switch on the front panel to the desired mode. For details, see "MODE Switch" in Chapter 2 "Module Nomenclature and Settings".
- (2) Set the ID switch.  
Use the ID switch on the front panel to set the device address.  
For the device address, you can use the utility to select whether to use the ID switch value (0 to 15) on the front panel or the address (0 to 31) set with the utility.
- (3) Connect the power cable and network cable to the RP-GPIB(FIT)GY.

Installing the utility software

- (1) Check the utility software installation environment.  
OS            Windows Vista, XP, 2000, Me, 98SE, 98 etc.  
Main body : The PC to install the utility software on must have any of the above operating systems running and can be networked via TCP/IP.  
For details, read Help supplied on the CD-ROM.
- (2) Prepare the PC before installation.  
Close any programs you have running on the PC to install the utility software on. If any screen saver or virus detection software is running, stop them temporarily.
- (3) Start installation.  
Load the bundled CD-ROM on the CD drive.  
Menu will be shown. Select [API-RPGPIB(W32)] and install it.
- (4) Follow the installation instructions on the screen to continue with the installation.  
When the utility software has been installed normally, the program is registered.
- (5) Start the application and check notes on it.

Set the IP address of RP-GPIB(FIT)GY

- (1) From the Start menu, choose "Programs" -> "API-RPGPIB(W32)" and start "Utility".
- (2) Select "Configuration" from the Utility menu.
- (3) Select the "Base" tab and set the IP address and subnet mask.  
See "Utility Software" in this chapter for details on how to use the utility software.

When you have finished setting up the module, restart your PC to make the settings take effect.



# Utility Software

This is a Windows application for detecting devices on the network, reading and writing setup data, upgrading firmware, and displaying status information.

These maintenance operations can be performed from a Windows PC via the LAN port.

## Starting of Utility Software

Upon activation of the “Utility” From the Start menu, choose “Programs” -> “API-RPGPIB(W32)”, “Utility software” is started.

You will see the following main menu.

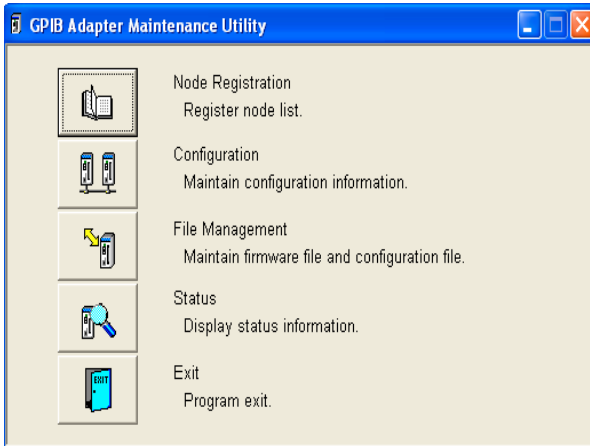

**Figure 5.1. Main menu**

### Node Registration

Edits the access point name list.

This list is used to detect devices connected by wired or wireless connection. Device names are added or deleted using the edit function.

### Configuration

Maintains configuration information.

View or enter settings for the selected devices.

### File Management

Used for firmware maintenance.

View firmware version, or write firmware.

### Status

Displays access point information.

View and verify information about the selected device.

### Exit

Program exit.

## Node Registration

This registers data for the devices on the network. Maintenance operations such as changing settings or upgrading the firmware are performed based on the data registered here. You must always perform node registration

Assigning names to the devices found by the automatic search makes it easier to identify the devices on the network.

Enter a name of up to 32 characters. A maximum of 1024 devices can be registered.

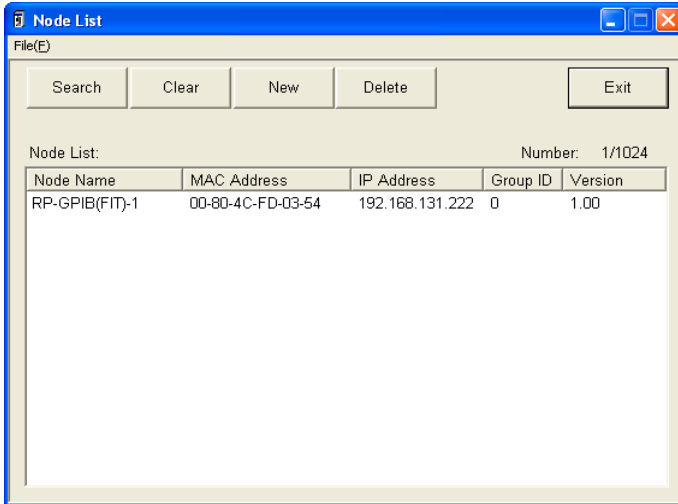

**Figure 5.2. Node Registration**

Button	Description
Search	This automatically detects and registers all devices connected to the same network group. If you also wish to manage devices located on the far side of an IP router, use the "New" button to register each device directly.
Clear	Deletes all registered data.
New	Registers data for a new device to be managed.
Delete	Deletes the data for the device selected in the node list
Exit	Returns to the main menu.

To modify the data displayed in the node list, double click on the node you wish to modify to open an edit window.

You can also use the "File" menu to save the current node list data to the hard disk or load a previously saved file.

## Configuration

This reads and writes the settings for the device selected in the “Node Name” field.

You can set basic parameters such as the operation mode as well as advanced parameters.

To apply your changes, write the settings to the device and then reboot it.

You can also use the “File” menu to save the currently displayed settings to the hard disk or load a previously saved file.

Button	Description
Password	Change the password for the selected device. To change, enter the current password and new password. The new password does not become active until the device is rebooted. The password can be up to 6 alphanumeric characters and is case sensitive.
Read	Read the settings for the selected device.
Write	Write the currently displayed settings to the selected device. The new settings do not become active until the device is rebooted.
Default	Restore the factory default settings. To apply these settings, write the settings to the device and then reboot it.
Reboot	Reboot the selected device.
Exit	Returns to the main menu.

\* Password input is required for the “Password”, “Read”, “Write”, and “Reboot” commands.

The factory default setting is no password. In this case, you do not need to enter anything.

## Base Configuration

This sets the IP parameters and other basic operating settings for the device. You must always set the IP parameters if installing the device in an existing network.

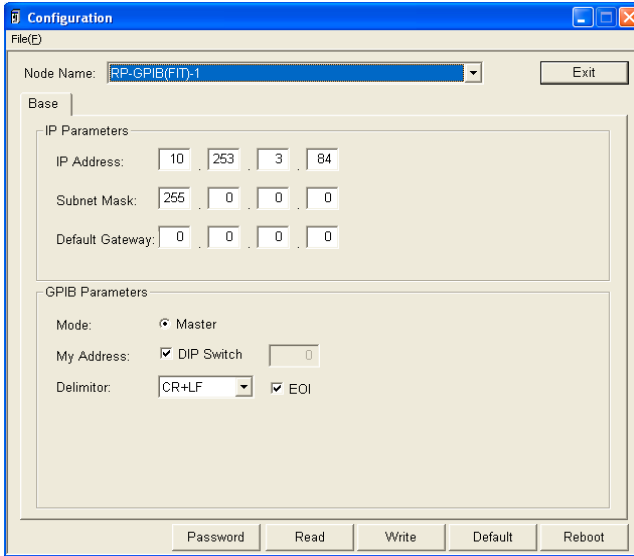

**Figure 5.3. Base Configuration**

Parameter	Factory setting	Input range	Description
IP Address	10.x.x.x*1		Set the IP address mask assigned by the network administrator.
Subnet Mask	255.0.0.0		Set the subnet mask assigned by the network administrator.
Default Gateway	0.0.0.0		Set the IP address of the default gateway.
Mode	Master	Fixed at Master	Specify the operating mode.
My address	0	0 to 30 assigned with ID switch.	Set my address.
Delimiter	CF+LF / Enable EOI	Not used / CR/LF / CR+LF Enable or disable EOI.	Set the delimiter for transmission and reception and enable or disable EOI.

\*1 : Factory setting of IP Address

A unique value is assigned using the lower 3 bytes of the 6-byte Ethernet address.

(Example)	Ethernet address		IP address
	00-80-4C-01-02-03	→	10.1.2.3
	00-80-4C-0D-0E-0F	→	10.13.14.15

The initial '10' is common to all settings.

## File Management

This dialog is used to get the current firmware version of devices on the network, perform firmware upgrades, and read or write the settings file.

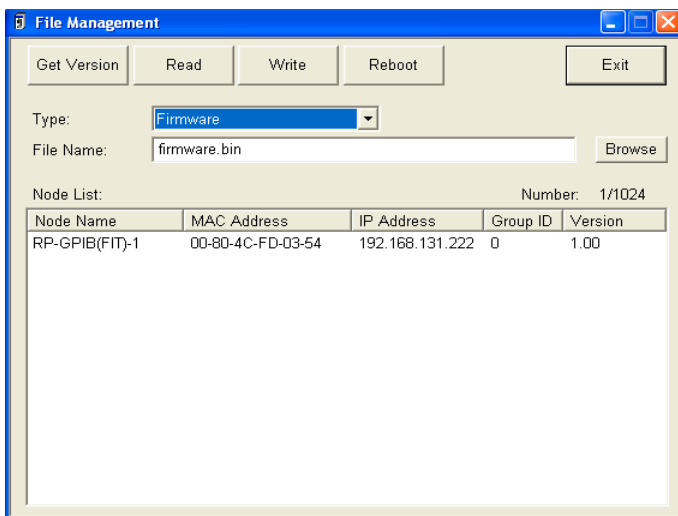

**Figure 5.4. File Management**

Button	Description						
Get Version	Retrieves the version number from all devices connected to the same network group or from a specified device only. To get information from devices on the other side of a router, you need to specify the device explicitly. In this case, the device's IP address must have been set correctly.						
Read	Read the firmware and settings file and save on the hard disk. *1						
Write	Write the firmware and settings file from the hard disk to the selected device. *1						
Reboot	Reboot the selected device.						
Exit	Returns to the main menu.						
Browse	Select the file and directory name. <table border="1" style="margin-left: 20px;"> <thead> <tr> <th>Type</th> <th>Selected File</th> </tr> </thead> <tbody> <tr> <td>Firmware</td> <td>File Name</td> </tr> <tr> <td>Configuration File</td> <td>Directory Name</td> </tr> </tbody> </table>	Type	Selected File	Firmware	File Name	Configuration File	Directory Name
Type	Selected File						
Firmware	File Name						
Configuration File	Directory Name						

\*1: File name

The file name contains the lower 3 bytes of the MAC address of the selected device.

(Example) Ethernet address      IP address  
 00-80-4C-01-02-03 → 010203.TXT

## Status

Reads operating information such as the environment settings and the send and receive counters from the device specified by “Node Name” and displays on the screen. The send and receive counters can also be cleared. However, data can only be cleared when scanning is stopped.

Button	Description
Exit	Returns to the main menu.
Scan Start	Reads data periodically (at the number of seconds specified by “Interval”). If “Interval” is “0”, data is read once only.
Stop	Stops reading data.

### Environment

Displays the current operating environment for the specified device.

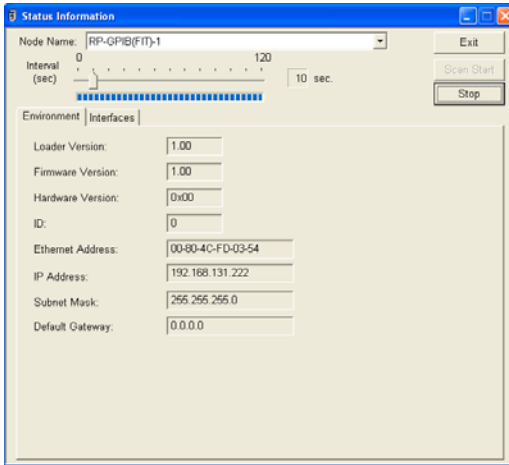
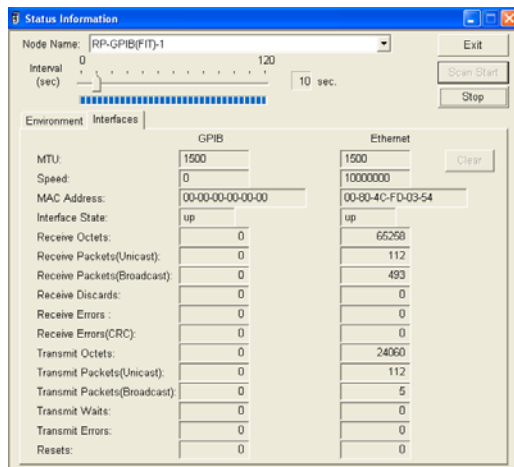

**Figure 5.5. Status (Environment)**

Parameters	Description
Loader Version	Version number of program for executing firmware.
Firmware Version	The version number of a firmware.
Hardware Version	The version number of a hardware.
ID	The device address set by ID switch now.
Ethernet Address	Ethernet address assigned to this device.
IP Address	Current IP address set for device.
Subnet Mask	The subnet mask set up now.
Default Gateway	The IP address of the default gateway set up now.

## Interfaces

Displays data for the device's GPIB and Ethernet interfaces including send and receive counters. The counters can be cleared when scanning is stopped.



**Figure 5.6. Status (Interfaces)**

Parameter	Description
MTU	Maximum data size able to be sent by this interface. The GPIB side is indeterminate.
Speed	Transmission speed for sending data from this interface. The GPIB side is indeterminate.
MAC Address	MAC address assigned to this interface. No MAC address is set for the RS-232C interface. The GPIB side is indeterminate.
Interface	The state of an interface of operation. up : An interface is operating. down : Not operating or no link.
Receive Octets	The number of bytes of the received data.
Receive Packets	The received number of packets
Receive Discards	The number which canceled the receiving packet by the shortage of a memory etc.
Receive Errors	The number of packets which the reception error generated.
Transmit Octets	The number of bytes of the transmitted data.
Transmit Packets	The transmitted number of Packets.
Transmit Waits	The number of the packet which is carrying out waiting for transmission.
Transmit Errors	The number of packets which the transmitting error generated.
Resets	The number of times which reset this interface.



# Installing the Driver for Windows

## Correspondence OS

The “Win32 version of RP-GRIP(FIT) driver” for Windows used in the remote control mode supports Windows Vista, XP, 2000, Me, 98SE and 98 etc.

For details, read Help supplied on the CD-ROM.

For details on API-RPGPIB(W32), refer to the help file.

## Installation

Installation procedure

- (1) Load the bundled CD-ROM on the CD drive.  
Menu will be shown. Select [API-RPGPIB(W32)] and install it.
- (2) Follow the installation instructions on the screen to continue with the installation.  
When the utility software has been installed normally, the program is registered.

Uninstallation procedure

- (1) Select [Add/Remove Program] from [Control Panel].
- (2) Select “API-RPGPIB(W32)” from the “Currently installed programs:” list, then click the [Change/Remove] button.
- (3) Follow the uninstall instructions on the screen to continue with the uninstallation.  
When the driver has been uninstalled normally, the program is deleted.

## Accessing the Help File

- (1) From the Start menu, choose “Programs” -> “API-RPGPIB(W32)” and start “Help”.



## Using Sample Programs

Bundled sample programs cover basic polling in master modes and support ADVANTEST Multimeters, YEW voltage generators, and SONY Tektronix oscilloscopes.

Use these sample programs as references for program development and operation check.

The sample programs are stored in \Program Files\CONTEC\API- RP GPIB(W32)\Samples.

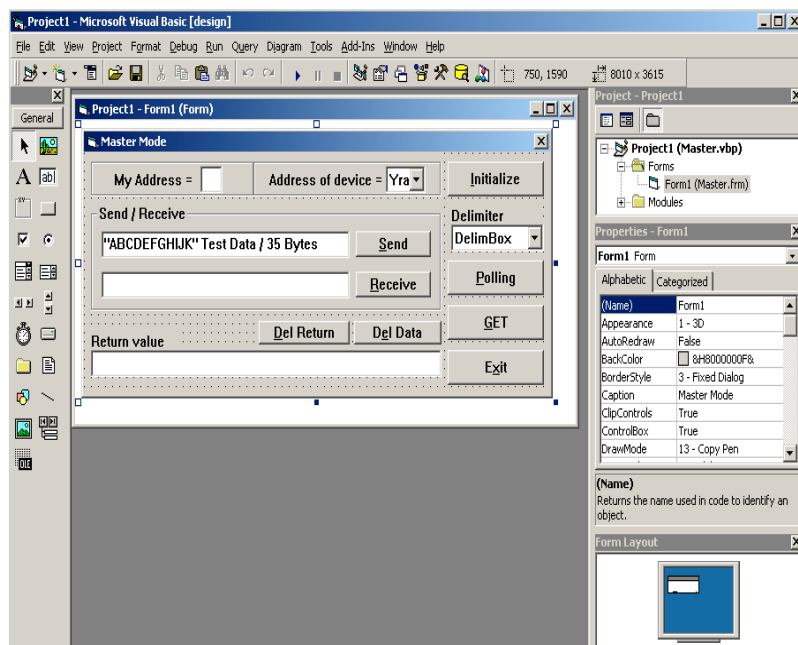

### Running a Sample Program

- (1) From the Start menu, choose “Programs” -> “API-RPGPIB(W32)” and start “Sample.....”.
- (2) A sample program is invoked.

Sample Programs – Examples

- Master Mode : Executes a series of operations in master mode.
- Multi-meter : Triggers a multimeter periodically (based on the timer and events) to sample and display data.
- Voltage Source control : Allows the master to gain control of a digital voltmeter at fixed intervals.
- Oscilloscope 1 : Receives screen data from an oscilloscope and displays it in a graph.
- Oscilloscope 2 : Receives screen data from an oscilloscope and saves it in CSV format.
- MultiLine Message : Send a multiline message for the remote device.

[Master Mode]



[Voltage Source control]

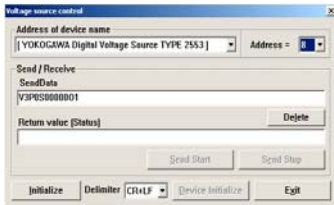

[MultiLine Message]

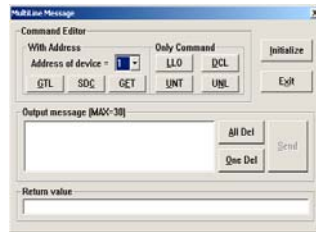

[Oscilloscope]



## 6. Troubleshooting

This chapter describes common problems that may occur with this product and what to do about them. If any problems occur that are not described here, check to confirm that the re-occur, then contact the store where you purchased the product, or the CONTEC information center.

### When Communication Fails

Check hardware

- Check that the LAN cables are connected correctly.
- Check that the GPIB cables are connected correctly.
- Is the MODE switch set correctly?
- Is the ID switch set correctly?
- Is the operating mode set correctly?

Check software

- Are the IP address and subnet mask set correctly?
- Is the device address set by correctly selecting the hardware setting (ID switch) and software setting (utility software)?
- Are the delimiter set correctly?

### When the RP-GPIB(FIT)GY Will Not Start

Check the power LED

- Be sure the power LED is on. If not, check that the AC adapter, power supply connector, and mains power plug are connected correctly.
- If the POWER LED does not illuminate within 3 minutes of turning on the power or resetting via the utility software, first check whether the MODE switch is set to "0".
  - If the MODE switch is not set to "0", change to "0", then restart.
  - If the MODE switch is set to "0", it is possible that the firmware is faulty. In this case, use the utility software to update the firmware.



## 7. System Reference

### Product Specifications

**Table 7.1. Functional Specification**

Specification		RP-GPIB(FIT)GY
GPIB unit	GPIB standard	IEEE488.1 or IEEE488.2
	Channel No.	1ch
	Data transfer	8-bit parallel / 3-lines handshake type
	Signal logic	Negative logic L level ... 0.8V or less H level ... 2.0V or more
Wired LAN unit	Ethernet standard	IEEE802.3
	Data transmission speed	10Mbps
	Access method	CSMA/CD
	Communication system	Half Duplex / Full Duplex
	Number of ports	1(10BASE-T)
Supply voltage		5.0VDC $\pm$ 5% (An AC adapter is provided)
Current consumption		0.6A (Max.)
Dimensions (mm)		50.4(W) x 64.7(D) x 94.0(H) (Not including protruding parts.)
Weight		190g

**Table 7.2. Installation Environment Conditions (Environment Specifications)**

Parameter		Requirement description
Operating temperature		0 - 50°C
Storage temperature		-10 - 60°C
Operating humidity		10 - 90%RH (No condensation)
Floating dust particles		Not extreme
Corrosive gases		None
Line-Noise resistance	Line-noise *	AC line/2kV, Signal line/1kV (IEC1000-4-4Level 3, EN61000-4-4Level 3)
	Static electricity resistance	Contact discharge/4kV (IEC1000-4-2Level 2, EN61000-4-2Level 2)
		Atmospheric discharge/8kV (IEC1000-4-2Level 3, EN61000-4-2Level 3)
Vibration resistance	Sweep resistance	10 - 57Hz/semi-amplitude 0.15mm, 57 - 150Hz/2.0G
		80minutes each in X, Y, and Z directions (JIS C0040-compliant, IEC68-2-6-compliant)
Impact resistance		15G, half-sine shock for 11ms in X, Y, and Z directions (JIS C004-compliant, IEC68-2-27-compliant)
Grounding		Class D grounding (previous class 3 grounding)

\* : At the time of appending AC adapter use

**Table 7.3. Software Specifications**

Specification	RP-GPIB(FIT)GY
Protocols	IP (RFC 791), ICMP (RFC 792), UDP (RFC 768), ARP (RFC 826)

**Table 7.4. AC Adapter Environmental Conditions (Environmental Specs)**

Specification	RP-GPIB(FIT)GY(Accessory)
AC supply voltage	100 - 240VAC 0.3A(Max.)
AC supply frequency	50 - 60Hz
DC supply voltage	5VDC $\pm$ 5% 2.0A(Max.)
Operating temperature	0 - 40°C
Operating humidity	10 - 90%RH (No condensation)
Airborne dust	Not extreme
Corrosive gases	None

**Table 7.5. Interface function**

Code	Function
SH1	Source handshake functions
AH1	Acceptor handshake functions
T6	Basic talker, serial polling, MLA talker release
L4	Basic listener MTA listener release
TE0	No extended talker functions
LE0	No extended listener functions
PP1	Configuration by remote message
C1	System controller function
C2	IFC send, controller in-charge
C3	REN send
C4	Response to SRQ
C26	Interface message send, parallel polling

# External Dimensions

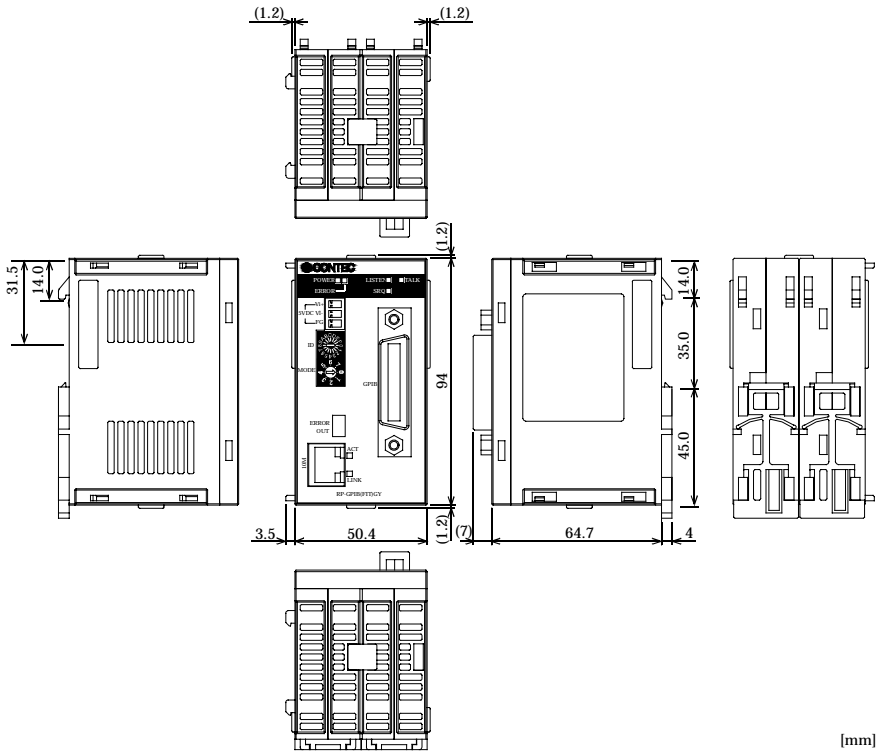

[mm]

Figure 7.1. External Dimensions



# RP-GPIB(FIT)GY

## User's Manual

---

CONTEC CO., LTD.

April 2007 Edition

3-9-31, Himesato, Nishiyodogawa-ku, Osaka 555-0025, Japan

Japanese <http://www.contec.co.jp/>

English <http://www.contec.com/>

Chinese <http://www.contec.com.cn/>

No part of this document may be copied or reproduced in any form by any means without prior written consent of CONTEC CO., LTD. [04122007]

---

[10082003]

Management No. A-46-805

[04122007\_rev4]

PartsNo. LYDB672