

MXE-210 Series

MXE-211/MXE-212

Fanless Embedded Computer

User's Manual



Manual Rev.: 1.0

Revision Date: Nov. 30, 2017

Part No: 50-1Z242-1000

Revision History

Revision	Release Date	Description of Change(s)
1.0	Nov. 30, 2017	Initial Release

Preface

Copyright 2017 ADLINK Technology, Inc.

This document contains proprietary information protected by copyright. All rights are reserved. No part of this manual may be reproduced by any mechanical, electronic, or other means in any form without prior written permission of the manufacturer.

Disclaimer

The information in this document is subject to change without prior notice in order to improve reliability, design, and function and does not represent a commitment on the part of the manufacturer.

In no event will the manufacturer be liable for direct, indirect, special, incidental, or consequential damages arising out of the use or inability to use the product or documentation, even if advised of the possibility of such damages.

Environmental Responsibility

ADLINK is committed to fulfill its social responsibility to global environmental preservation through compliance with the European Union's Restriction of Hazardous Substances (RoHS) directive and Waste Electrical and Electronic Equipment (WEEE) directive. Environmental protection is a top priority for ADLINK. We have enforced measures to ensure that our products, manufacturing processes, components, and raw materials have as little impact on the environment as possible. When products are at their end of life, our customers are encouraged to dispose of them in accordance with the product disposal and/or recovery programs prescribed by their nation or company.

Trademarks

Product names mentioned herein are used for identification purposes only and may be trademarks and/or registered trademarks of their respective companies.

Conventions

Take note of the following conventions used throughout this manual to make sure that users perform certain tasks and instructions properly.



NOTE:

Additional information, aids, and tips that help users perform tasks.



CAUTION:

Information to prevent **minor** physical injury, component damage, data loss, and/or program corruption when trying to complete a task.



WARNING:

Information to prevent **serious** physical injury, component damage, data loss, and/or program corruption when trying to complete a specific task.

Table of Contents

Preface	iii
List of Tables	xi
List of Figures	xiii
1 Introduction	1
1.1 Features	2
1.2 Specifications	3
1.3 Mechanical Drawings	5
1.4 Front Panel I/O Connectors	8
1.4.1 Power Button	8
1.4.2 LED Indicators	9
1.4.3 Reset Button	9
1.4.4 DisplayPort Connector	9
1.4.5 Dual Gigabit Ethernet Ports	11
1.4.6 USB 3.0 Port	12
1.4.7 DB-9P COM Port Connector	12
1.4.8 DC Power Supply Connector	13
1.5 Internal I/O Connectors	14
1.5.1 Internal HUART Interface Wafer	16
1.5.2 USIM Port	16
1.5.3 Internal USB2.0 Interface Wafer	17
1.5.4 Internal I2C Interface Wafer	17
1.5.5 Clear CMOS Jumper	18
1.5.6 +5V GPS Antenna Power Header	19
1.5.7 Internal SATA Interface Wafer	19
1.5.8 Extended Power Wafer	20
1.5.9 Internal I2C Interface Wafer	21
1.5.10 Extended Reset Wafer	21
1.5.11 RTC Battery Header	22

1.5.12	Internal Speaker Wafer (Optional).....	22
1.5.13	Internal MIC-IN & HP-OUT Wafer (Optional).....	23
1.6	Adapters and Other Accessories	23
2	Getting Started	25
2.1	Unpacking Checklist	25
2.2	Installing Mini-PCIe Devices	25
2.3	Installing Mini-PCIe mSATA Module.....	29
2.4	Installing Mini-PCIe WiFi Module.....	31
2.5	Installing Mini-PCIE 3G/4G LTE Module.....	33
2.6	Connecting DC Power	35
2.7	DIN rail Mounting	35
2.8	Wall Mounting	38
2.9	Cooling Considerations.....	39
3	Driver & Application Installation	41
3.1	Installing the Chipset Driver.....	41
3.2	Installing the Graphics Driver.....	42
3.3	Installing the Ethernet Driver.....	42
3.4	Installing the USB 3.0 Driver.....	43
3.5	Installing the I/O Driver	43
3.6	Installing the SEMA Utility, WDT and DI/O Drivers.....	43
A	Appendix: BIOS Setup.....	45
A.1	Main	46
A.1.1	BIOS Information	46
A.1.2	System Time/System Date	46
A.1.3	Board Information	47
A.2	Advanced.....	48
A.2.1	CPU Configuration.....	49
Active Processor Cores	49	
Intel Virtualization Technology	49	
VT-d	49	

	Turbo Mode	49
	Critical Trip Point	50
	Passive Cooling Trip Point	50
A.2.2	Graphics Configuration.....	50
	GTT Size	50
	Aperture Size	50
	DVMT Pre-Allocated	50
	DVMT Total Gfx Mem	51
A.2.3	Onboard Device Configuration	51
	COM1 Control	51
	COM2 Control	51
	HSUART	51
	LAN #1 (Intel I210)	52
	LAN #2 (Intel I210)	52
	Realtek Audio Support	52
	Console Redirection	52
	Console Redirection Settings (COM 1)	53
	Console Redirection	56
	Console Redirection Settings (COM 2)	56
A.2.4	Advanced Power Management	59
	Power Supply Unit	59
	State After G3	59
	RTC Wake system from S5	59
	LAN #1 Wake	60
	LAN #2 Wake	60
A.2.5	USB Configuration.....	60
	XHCI Hand-off	60
	USB Mass Storage Driver Support	60
	USB transfer time-out	61
	Device reset time-out	61
	Device power-up delay	61
A.2.6	SATA Configuration.....	61

Port	61
A.2.7 TPM Configuration.....	62
Security Device Support	62
A.2.8 Network Stack Configuration	63
Network Stack	63
A.2.9 System Management.....	64
Flags	68
Power Up	69
A.2.10 Miscellaneous.....	70
OS Selection	70
A.2.11 Intel® I210 Gigabit Network Connection	71
Blink LEDs	71
A.2.12 NIC Configuration	72
Link Speed	72
Wake On LAN	72
A.3 Security.....	73
Administrator Password	73
User Password	73
BIOS Lock	73
A.3.1 Secure Boot.....	74
A.4 Boot	75
Setup Prompt Timeout	75
Bootup NumLock State	75
Quiet Boot	75
Fast Boot	75
Boot Option Priorities	76
A.5 Save & Exit	76
Save Changes and Exit	76
Discard Changes and Exit	76
Save Changes and Reset	77
Discard Changes and Reset	77
Save Changes	77

Discard Changes	77
Restore Defaults	77
Save as User Defaults	77
Restore User Defaults	77
Launch EFI Shell from filesystem device	77
Important Safety Instructions	79
Getting Service.....	83

This page intentionally left blank.

List of Tables

Table 1-1:	LED Operation Indicators	9
Table 1-2:	DisplayPort Pin Assignment	10
Table 1-3:	Gigabit Ethernet Port LED Function	11
Table 1-4:	DB-9P COM Port Pin Assignment	13
Table 1-5:	Internal I/O Legend	16
Table 1-6:	HSUART Interface Wafer Pin Definitions	16
Table 1-7:	USB2.0 Interface Wafer Pin Definitions.....	17
Table 1-8:	Internal I2C Interface Wafer Pin Definitions	18
Table 1-9:	Clear CMOS Jumper Pin Definition	18
Table 1-10:	+5V GPS Antenna Power Connector Pin Definition .	19
Table 1-11:	SATA Wafer Pin Definition	20
Table 1-12:	Extended Power Header Connector Pin Definition...	20
Table 1-13:	I2C Box Header Connector Pin Definition	21
Table 1-14:	Extended Reset Header Connector Pin Definition ...	22
Table 1-15:	RTC Battery Connector Pin Definition	22
Table 1-16:	Speaker Wafer Pin Definition	23
Table 1-17:	MIC-IN & HP-OUT Wafer Pin Definition	23

This page intentionally left blank.

List of Figures

Figure 1-1:	MXE-210 Functional Block Diagram.....	5
Figure 1-2:	Top View.....	6
Figure 1-3:	Front View	6
Figure 1-4:	(Right) Side View	7
Figure 1-5:	(Left) Side View	7
Figure 1-6:	Front Panel I/O	8
Figure 1-7:	DB-9P COM Port	12
Figure 1-8:	Mainboard Top View.....	14
Figure 1-9:	Mainboard Underside View	15

This page intentionally left blank.

1 Introduction



ADLINK's new Matrix MXE-210 Series compact embedded platform, based on the Intel® Atom x7-E3950/X5-E3930 processor, delivers the most reliable I/O design for maximum connectivity, and a full aluminum alloy enclosure with industry-class construction makes it the embedded system of choice for industrial automation and applications demanding reliability in harsh environments. Utilizing ADLINK's embedded SEMA intelligent middleware, the MXE-210 Series delivers the remote manageability and robustness required by mission critical operations.

The MXE-210 Series accommodates rich industrial I/O variety in an compact system, with DisplayPort, two GbE by Intel network interface controllers, 2 COM ports with BIOS-configurable among RS232/RS422 and RS485, 2 USB 2.0 and 2 USB 3.0 with dedicated bandwidth, optional audio for mic-in/line-out support, one mSATA SSD, one optional 2.5" SATA SSD, and one Micro SD support, and dual mini PCIe slots with USIM socket supporting communication with connections such as WiFi, BT, 3G, LoRa, and 4G LTE, the MXE-210 Series enables seamless interconnection, ensuring interoperability between systems.

Matrix's proven rugged construction assures operation in harsh environments with operating shock tolerance up to 100 G, 5 Grms

vibration resistance, and optionally available extended operating temperature ranges of -20°C to 70°C and -40°C to 85°C.

The MXE-210 Series maximizes manageability and security for a world of applications, delivering efficient remote monitoring of system activity and health in real time via different security building blocks, such as hardware-based root integrity protection and software-based prevention of unauthorized software and malware takeover, system control over a robust secured channel, and complete, fully manageable utilization of system resources.

All told, the MXE-210 presents an intelligent, robust embedded system supporting wide application development and easy service deployment, for outstanding performance in intelligent transportation, facility management, industrial automation, and IoT operations.

1.1 Features

- ▶ Intel® Atom X7-E3950/X5-E3930 processor
- ▶ Extremely compact 140 (W) x 110 (D) x 58 (H) mm
- ▶ Rich I/O:
 - ▷ 1 x DP, 2 x GbE, 2 x COM(RS232/RS422/RS485), 2x USB 3.0
 - ▷ Optional audio with Mic-in and line-out/speaker
 - ▷ 2x full-size Mini PCIe slots (1 x mini PCIe with USIM)
 - ▷ 1x mSATA SSD, 1x 2.5" SATA SSD (Optional), 1x MicroSD slot
 - ▷ 2 x I2C wafer connector, 1 x UART wafer connector, 1 x USB2.0 wafer connector, 1 x USB 2.0 type A dongle
- ▶ DIN rail mounting, optional wall mounting

1.2 Specifications

	MXE-211	MXE-212
System Core		
Processor	Intel® Atom X7-E3950	Intel® Atom X5-E3930
Chipset	SoC	
Video	1 x DisplayPort 1.2 (supports DP++)	
Memory	2 GB DDR3L 1600 MHz SODIMM module (Up to 8 GB support)	
I/O Interface		
Ethernet	2 x GbE ports(2 x Intel I210IT/ co-lay with I210AT)	
Serial Ports	2 x BIOS-configurable RS232/422/485(COM1 to COM2)	
USB	2 x USB 3.0 ports + 2 x USB 2.0 ports	
Audio	Optional 1 mic-in and 1 line-out/speaker	
Mini PCIe	2x full size mini PCIe card slots	
USIM	1 x USIM socket for 3G/4G LTE communication	
WDT	Watchdog timer support from SEMA 3.5	
Internal I/O extension	2 x I2C wafer connector, 1 x UART wafer connector, 1 x USB2.0 wafer connector, 1 x USB 2.0 type A dongle	
Power Supply		
DC Input	Built-in 6 to 36 VDC wide-range DC input 3P pluggable connectors with latch (GND, V-, V+)	
AC Input	Optional 40W external AC/DC adapter for AC input	
Storage		
mSATA	1x mSATA slot with full size mini PCIe	
SATA	Optional 1 x 2.5" SATA SSD (connected via internal SATA wafer)	
Micro SD	1 x micro SD slot (Up to 32GB)	
Physical		
Dimensions	140 (W) x 110 (D) x 58 (H) mm (5.5" x 4.3" x 2.3")	
Weight	0.95 kg (2.06 lb.)	
Mounting	DIN rail, optional wall-mount kit	
Environmental		
Operating Temperature	Standard: 0°C to 50°C	

	MXE-211	MXE-212
Extended Operating Temperature	-20°C to 70°C (with optional industrial mSATA/SATA SSD)	
Ultra-Extended Operating Temperature	N/A	-40°C to 85°C (with optional industrial mSATA/SATA SSD and heat spreader kit)
Storage Temperature	-40°C to 85°C (excl. HDD/MicroSD)	
Humidity	Approx. 95% @ 40°C (non-condensing)	
Vibration	Operating, 5 Grms, 5-500 Hz, 3 axes (w/ mSATA)	
ESD	Contact +/-4 KV and Air +/-8 KV	
Shock	Operating 100 G, half sine 11 ms duration w/ mSATA	
EMC	CE & FCC Class B (EN61000-6-4/EN61000-6-2)	
Safety	UL, CB	



NOTE:

Cold boot of the system at -20°C and operation with 100% loading at 70°C is provided when the industrial solid-state drive storage option is implemented.

Power Consumption		
Power off	3.6W	In shutdown mode with DC input and only USB keyboard/mouse
System Idle	11.2W	Under Windows Desktop with no application programs executed
Processor full load	35.2W	Under Windows with 100% CPU utilization and 2D/3D graphics load
System full load	25W	Under Windows with 100% CPU utilization and simultaneous access to all I/O devices
Recommended power supply	40W	With consideration of voltage de-rating under high environmental temperature

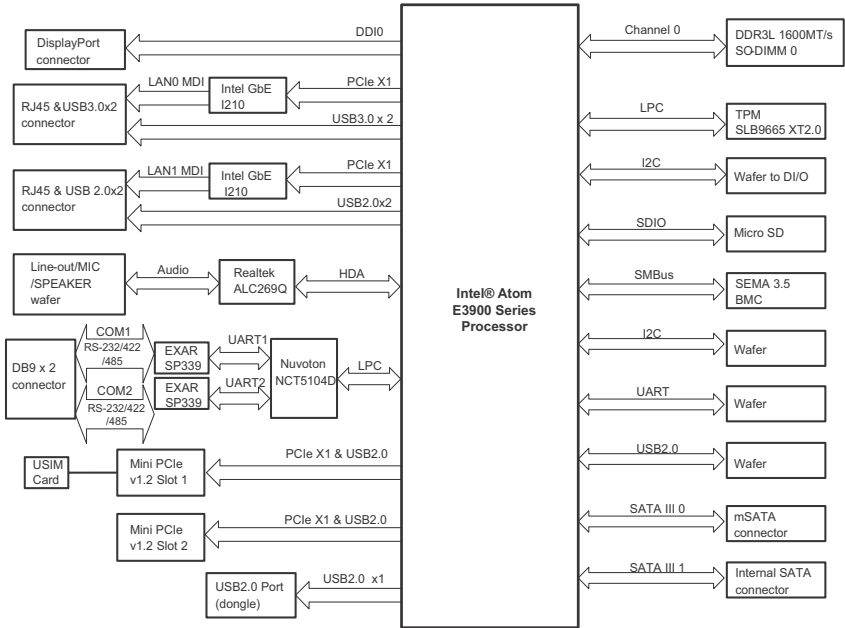

Figure 1-1: MXE-210 Functional Block Diagram

1.3 Mechanical Drawings



NOTE:

All dimensions shown are in millimeters (mm) unless otherwise stated.

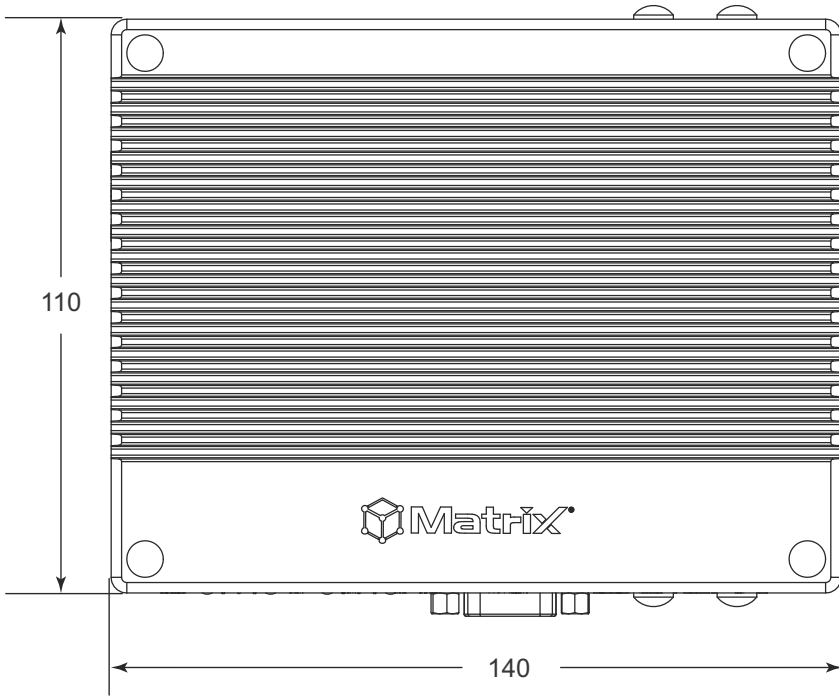

Figure 1-2: Top View

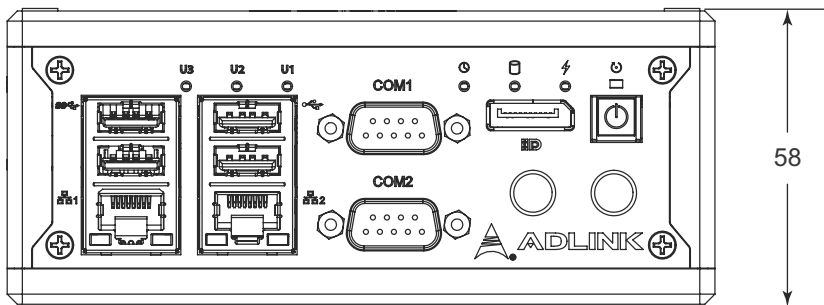

Figure 1-3: Front View

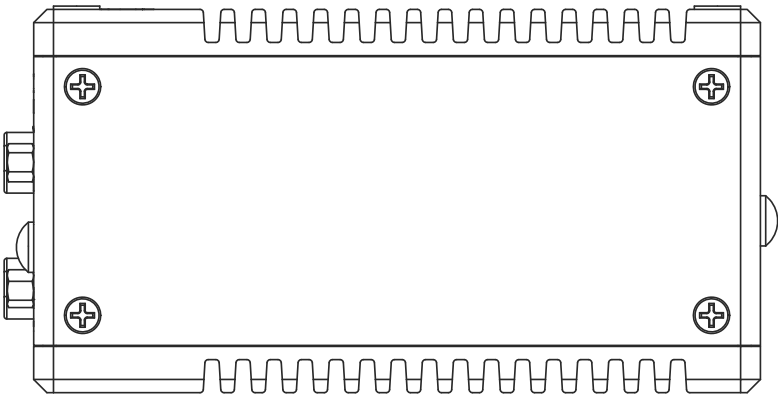

Figure 1-4: (Right) Side View

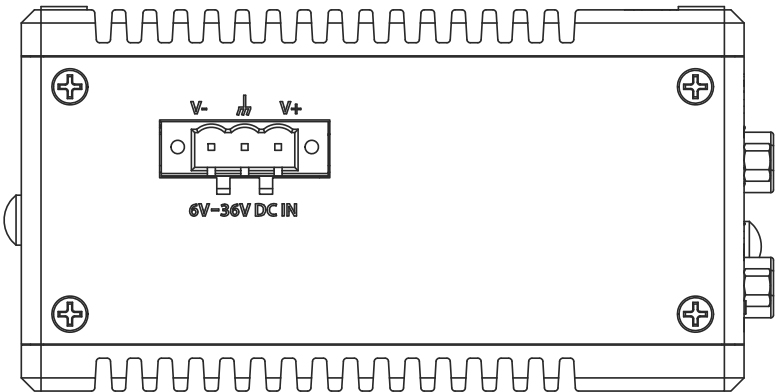

Figure 1-5: (Left) Side View

1.4 Front Panel I/O Connectors

The following lists I/O connectors located on the front panel of the MXE-210, as labeled.



Figure 1-6: Front Panel I/O

- ▶ Power button
- ▶ Reset button
- ▶ Antenna port
- ▶ DP connector
- ▶ LED operation indicators (x3)
- ▶ LED user-defined indicators (x3)
- ▶ DB-9P COM ports (x2)
- ▶ GbE ports (x2)
- ▶ USB2.0 ports (x2)
- ▶ USB3.0 ports (x2)

1.4.1 Power Button

The power button is a non-latched push button with a blue LED indicator. System is turned on when button is pressed, and the power LED lit. If the system hangs, depressing the button for 5 seconds powers down the system.

1.4.2 LED Indicators

In addition to the LED of the power button, three LEDs on the front panel indicate the following operations.

Indicator	Color	Description
Watchdog (WDT)	Yellow	Indicates watchdog timer status. Flashes when watchdog timer starts, and when timer is expired, system will auto-reboots.
HDD	Red	When blinking, indicates the SATA hard driver is active
Standby	Blue	Indicates the system is in power standby mode

Table 1-1: LED Operation Indicators

As well, three user-defined indicators can be configured by GPIO settings.

1.4.3 Reset Button

The reset button executes hard reset for the MXE-210.

1.4.4 DisplayPort Connector

One DisplayPort connector on the front panel supports the DP1.2 standard specification, and can connect to VGA, DVI, HDMI, and Display Port monitors via DisplayPort to VGA adapter cable, DisplayPort to DVI adapter cable, or DisplayPort to HDMI adapter

cable and Display Port cable, with DP1.2 support for resolutions up to 4096 x 2160 at 60Hz.

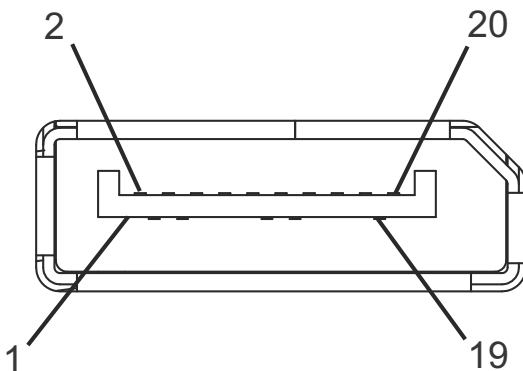

Pin	Signal	Pin	Signal
1	ML_Lane0_P	11	GND
2	GND	12	ML_Lane3_N
3	ML_Lane0_N	13	Config1
4	ML_Lane1_P	14	Config2
5	GND	15	Aux_P
6	ML_Lane1_N	16	GND
7	ML_Lane2_P	17	Aux_N
8	GND	18	Hot Plug
9	ML_Lane2_N	19	Return
10	ML_Lane3_P	20	DP_PWR_+3.3V

Table 1-2: DisplayPort Pin Assignment

1.4.5 Dual Gigabit Ethernet Ports

Two Gigabit Ethernet ports on the front panel support the Intel i210IT GbE controller, which provides:

- ▶ IEEE 802.3az Energy Efficient Ethernet
- ▶ IEEE 1588/802.1AS precision time synchronization
- ▶ IEEE 802.3av traffic shaper
- ▶ Interrupt moderation, VLAN support, IP checksum offload
- ▶ PCIe OBFF (Optimized Buffer Flush/Fill) for improved system power management
- ▶ Four transmit and four receive queues
- ▶ RSS and MSI-X to lower CPU utilization in multi-core systems
- ▶ ECC - error correcting memory in packet buffers
- ▶ Wake-On-LAN
- ▶ NC-SI for greater bandwidth passthrough
- ▶ Preboot eXecution Environment (PXE) flash interface support
- ▶ Jumbo frame support

LED	LED Color	Status	Description
Active/Link	Yellow	OFF	Ethernet port is disconnected
		ON	Ethernet port is connected with no activity
		Flashing	Ethernet port is connected and active
Speed	Green/ Yellow	OFF	10 Mbps
		Green	100 Mbps
		Yellow	1000 Mbps

Table 1-3: Gigabit Ethernet Port LED Function

1.4.6 USB 3.0 Port

The USB 3.0 port supports Type A connection, compatible with SuperSpeed, Hi-Speed, full-speed and low-speed USB devices, with support for multiple boot devices, including USB flash, USB external HDD, and USB CD-ROM drivers and boot priority and boot device configured in BIOS.



NOTE:

When using USB CD-ROM via USB 3.0 port to re-install or repair the OS, cold boot should be utilized

1.4.7 DB-9P COM Port Connector

Through a D-sub 9-pin connector, COM1 or COM2 supports RS-232, with the other selectively supporting RS-232/RS-422/RS-485 mode by BIOS setting.

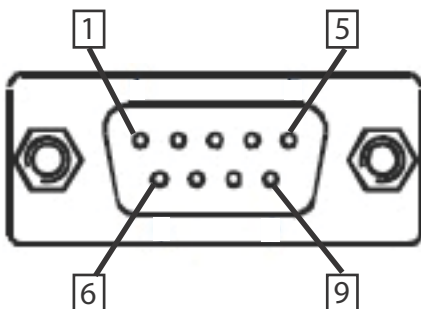

Figure 1-7: DB-9P COM Port

Pin	Signal		
	RS-232	RS-422	RS-485
1	DCD#	TXD422-	485-
2	RXD	TXD422+	485+
3	TXD	RXD422+	N/C
4	DTR#	RXD422-	N/C
5	GND	N/C	N/C

Pin	Signal		
6	DSR#	N/C	N/C
7	RTS#	N/C	N/C
8	CTS#	N/C	N/C
9	RI#	N/C	N/C

Table 1-4: DB-9P COM Port Pin Assignment

1.4.8 DC Power Supply Connector

Located on the left side panel of the MXE-210.

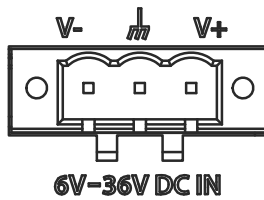

1.5 Internal I/O Connectors

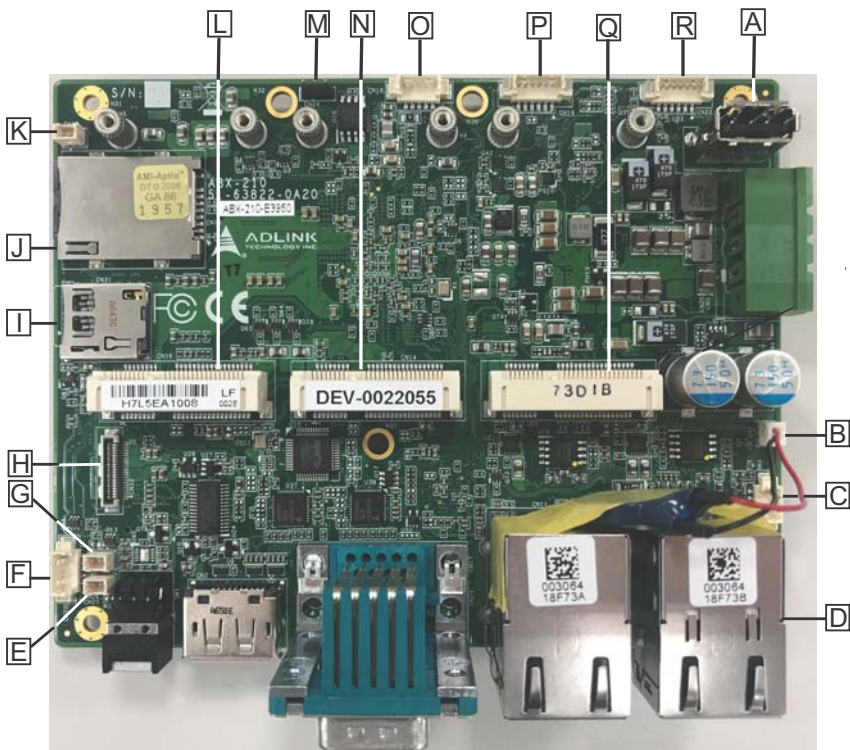

Figure 1-8: Mainboard Top View

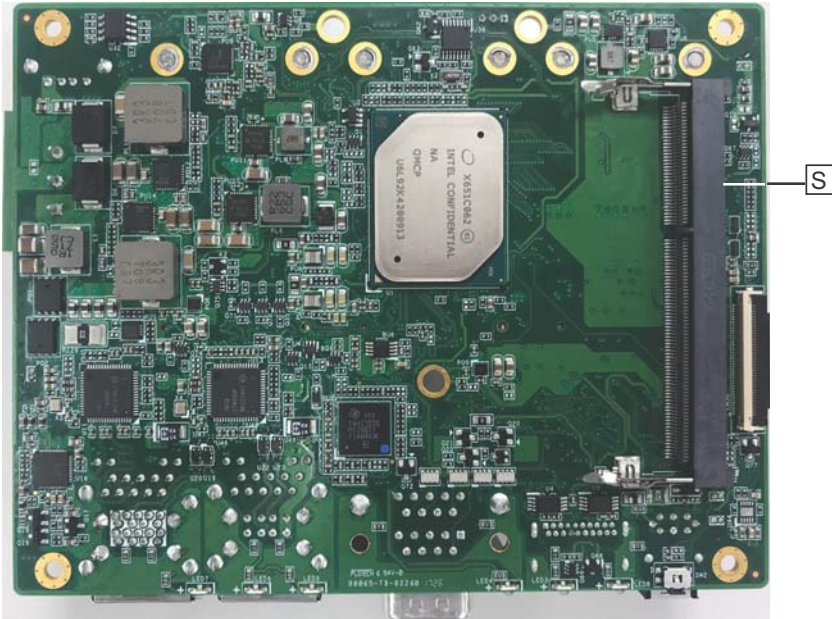

Figure 1-9: Mainboard Underside View

A	USB2.0 internal dongle (CN21)
B	RTC Battery Header (CN_BAT)
C	Internal Speaker Wafer (Optional) (CN8)
D	Internal MIC-IN & HP-OUT Wafer (Optional) (CN6)
E	Extended reset wafer (CN27)
F	Internal I2C Interface Wafer (CN20)
G	Extended power wafer (CN26)
H	Internal SATA Interface Wafer (CN32)
I	Micro SD card socket (CN31)
J	USIM slot (CN15)
K	+5V GPS Antenna Power Header (CN12)
L	Mini-PCIe slot 2 (CN16)
M	Clear CMOS Jumper (CN24)
N	Mini-PCIe slot 1 (CN14)
O	Internal I2C Interface Wafer (CN18)
P	Internal USB2.0 Interface Wafer (CN19)

Q	mSATA slot (CN5)
R	Internal HSUART Interface Wafer (CN22)
S	DDR3L SO-DIMM slot (CN1)

Table 1-5: Internal I/O Legend

1.5.1 Internal HSUART Interface Wafer

HSUART signal and +3.3V power are provided by the connector with cable.

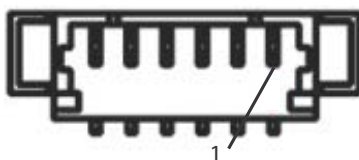

Pin	Signal
1	+3.3V
2	SOC_UART1_RX_CON
3	SOC_UART1_TX_CON
4	SOC_UART1_CTS_CON-L
5	SOC_UART1_RTS_CON-L
6	GND

Table 1-6: HSUART Interface Wafer Pin Definitions

1.5.2 USIM Port

Use of 3G/4G mini-PCIe module requires a SIM card for communication with telecom operator. The MXE-210 provides a USIM port connected to the mini-PCIe connector, with which a SIM card and 3G/4G mini-PCIe module can be installed to facilitate 3G/4G communication.

1.5.3 Internal USB2.0 Interface Wafer

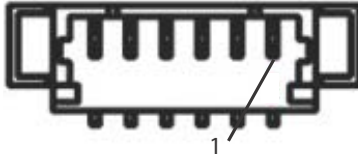

Pin	Signal
1	+5V
2	SOC_USB2_D6_P
3	SOC_USB2_D6_N
4	GND
5	+3.3V
6	USB2_WAFER-L

Table 1-7: USB2.0 Interface Wafer Pin Definitions

1.5.4 Internal I2C Interface Wafer

I2C and +3.3V/+5V power by this connector with cable. are provided by the connector with cable.

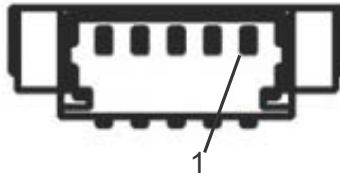

Pin	Signal
1	GND
2	SOC_I2C1_CLK

Pin	Signal
3	SOC_I2C1_DAT
4	+3.3V
5	+5V

Table 1-8: Internal I2C Interface Wafer Pin Definitions

1.5.5 Clear CMOS Jumper

Under conditions in which the MXE-210 fails to boot, clearing the BIOS content stored in CMOS and restoring the default settings may be effective. To clear CMOS, short Pin 1 and Pin 2 of CN24 and remove the jumper, after which the CMOS will be restored to factory default settings.

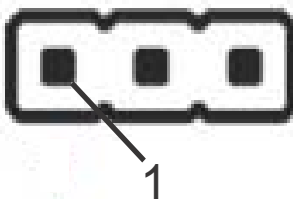

Pin	Signal
1	SOC_RTC_TEST-L
2	GND
3	SOC_RTC_RST-L

Table 1-9: Clear CMOS Jumper Pin Definition

1.5.6 +5V GPS Antenna Power Header

External +5V power is reserved for GPS antenna power, with +5V provided by this connector with cable.

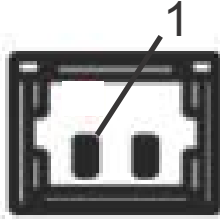

Pin	Signal
1	+5
2	GND

Table 1-10: +5V GPS Antenna Power Connector Pin Definition

1.5.7 Internal SATA Interface Wafer

Reserved for extended 2.5" SSD, providing SATA signal and +3.3V/+5V power with cable.

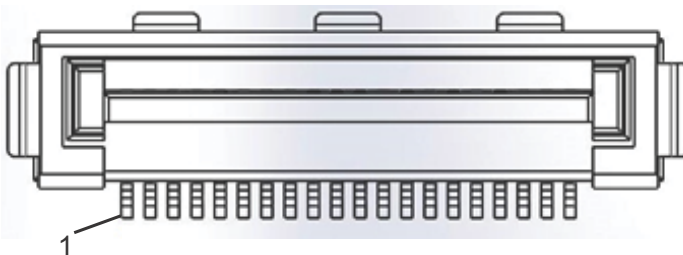

Pin	Signal	Pin	Signal
1	GND	13	+5V
2	SOC_SATA_TX1_P_C	14	+5V
3	SOC_SATA_TX1_N_C	15	+5V
4	GND	16	NC
5	SOC_SATA_RX1_N_C	17	GND
6	SOC_SATA_RX1_P_C	18	GND
7	GND	19	GND
8	NC	20	GND
9	+3.3V	G1	GND
10	+3.3V	G2	GND
11	+3.3V	G3	GND
12	NC	G4	GND

Table 1-11: SATA Wafer Pin Definition

1.5.8 Extended Power Wafer

Providing internal connectors for the power button.

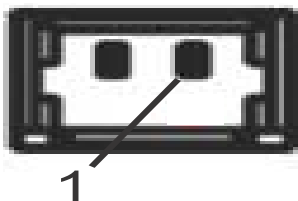

Pin	Signal
1	PWR_BTN_CN-L
2	GND

Table 1-12: Extended Power Header Connector Pin Definition

1.5.9 Internal I2C Interface Wafer

Provides the I2C signal and +3.3V power with cable.

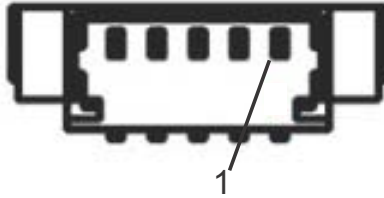

Pin	Signal
1	+3.3V
2	SOC_I2C0_DAT
3	SOC_I2C0_CLK
4	SOC_I2C0_INT
5	GND

Table 1-13: I2C Box Header Connector Pin Definition

1.5.10 Extended Reset Wafer

Provides internal connectors for the reset button.

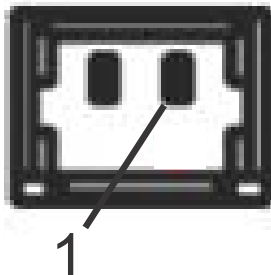

Pin	Signal
1	RESET_BTN_CN-L
2	GND

Table 1-14: Extended Reset Header Connector Pin Definition

1.5.11 RTC Battery Header

Links to the 3V coin battery pack for system RTC function.

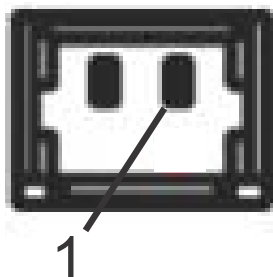

Pin	Signal
1	P_+3V3_VBAT
2	GND

Table 1-15: RTC Battery Connector Pin Definition

1.5.12 Internal Speaker Wafer (Optional)

Provides the audio speaker signal, supporting 2x 2W8Ω speaker.

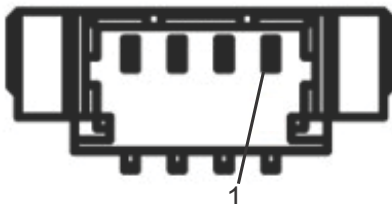

Pin	Signal
1	SPKR_L_P
2	SPKR_L_N
3	SPKR_R_P
4	SPKR_R_N

Table 1-16: Speaker Wafer Pin Definition

1.5.13 Internal MIC-IN & HP-OUT Wafer (Optional)

Provides MIC-IN and HP-OUT signals with cable.

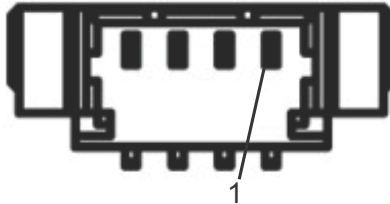

Pin	Signal
1	EX_MIC_CN
2	HP_CN_L
3	HP_CN_R
4	AGND_AUDIO

Table 1-17: MIC-IN & HP-OUT Wafer Pin Definition

1.6 Adapters and Other Accessories

Device adaptors and other optional accessories should only be obtained through your ADLINK dealer. For more information, see “Getting Service” on page 83.

This page intentionally left blank.

2 Getting Started

2.1 Unpacking Checklist

Before unpacking, check the shipping carton for any damage. If the shipping carton and/or contents are damaged, inform your dealer immediately. Retain the shipping carton and packing materials for inspection. Obtain authorization from your dealer before returning any product to ADLINK. Ensure that the following items are included in the package.

- ▶ MXE-210 unit
- ▶ DIN rail brackets
- ▶ Screw pack for DIN rail and storage fixing
- ▶ Quick Start Guide

2.2 Installing Mini-PCIe Devices

Before installing, remove the chassis underside as follows.

1. Remove the 9 screws as shown.







2. Remove the chassis underside.

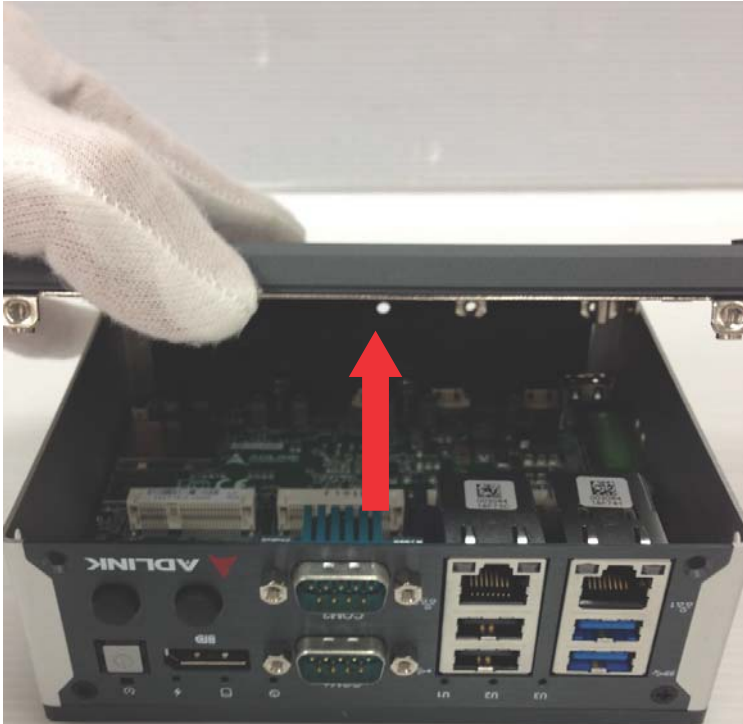

2.3 Installing Mini-PCle mSATA Module

1. Insert the mini-PCIE mSATA module into the slot at an angle



2. Depress the mini-PCI-E mSATA module until seated and fix with two 2 M2.5-P-head-L5 screws.

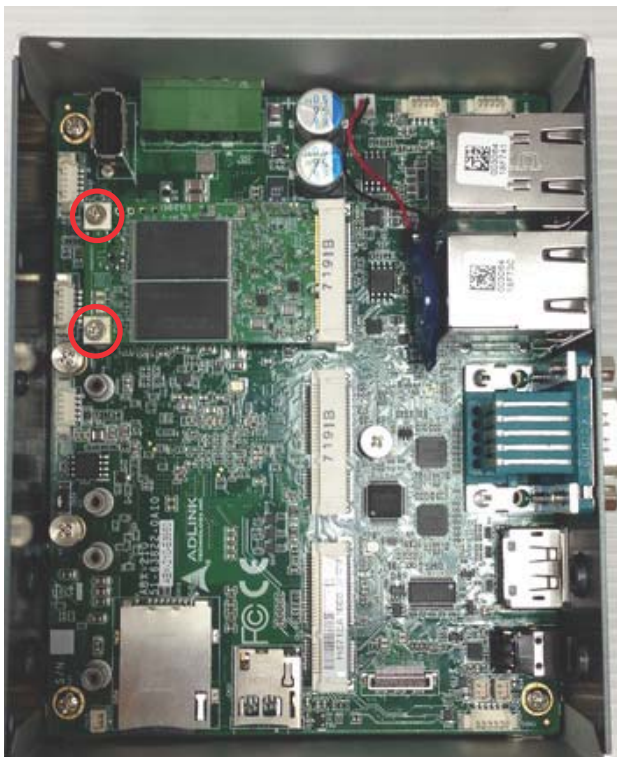

3. Replace the chassis underside.

2.4 Installing Mini-PCle WiFi Module

1. Insert the mini-PCIE WiFi module into the slot at an angle



2. Depress the module until seated and fix with two 2 M2.5-P-head-L5 screws.

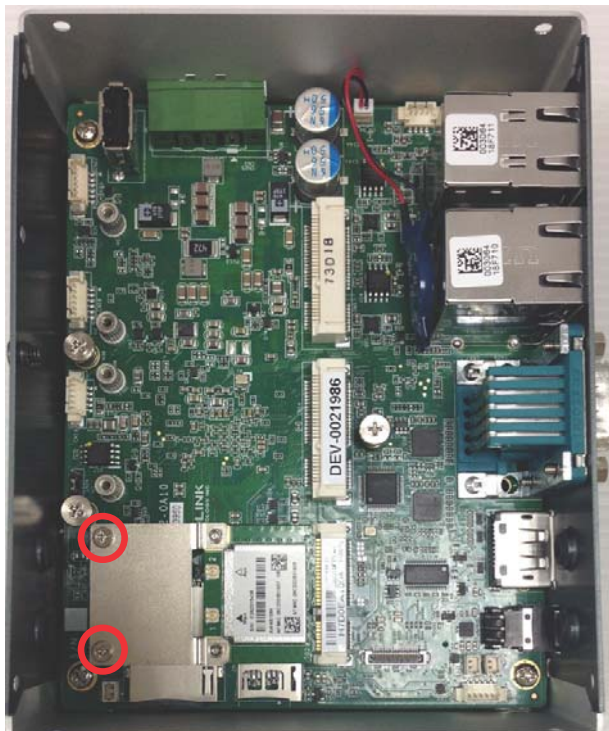

3. Replace the chassis underside.

2.5 Installing Mini-PCIE 3G/4G LTE Module

Use of the mini-PCIE 3G/4G LTE module requires installation of a SIM card.

1. Remove the remaining two screws from the right side panel and remove the panel.



2. Insert the SIM card into the slot.



3. Insert the mini-PCIE 3G/4G LTE module into the slot at an angle



4. Replace the side panel and chassis underside.

2.6 Connecting DC Power



Before providing DC power to the MXE-210, ensure the voltage and polarity provided are compatible with the DC input. Improper input voltage and/or polarity can be responsible for system damage.

Active DC power sources must comply with LPS and SELV circuits with no energy hazard, as well as the following.

- ▶ IEC 60950-1:2005+A1:2009+A2: 2013
- ▶ Output voltage: 6 to 36VDC
- ▶ Output current: 4.2 to 0.7A minimum
- ▶ Tma: 50°C min.

The DC power input connector of the MXE-210 utilizes V+, V-, and chassis ground pins, and accepts input voltage as shown previously.

2.7 DIN rail Mounting

The MXE-210 controller is shipped with DIN rail mounting brackets and accessory screws, with mounting procedures as follows.

1. Prepare the DIN rail mounting bracket and 2 M4-F head screws.

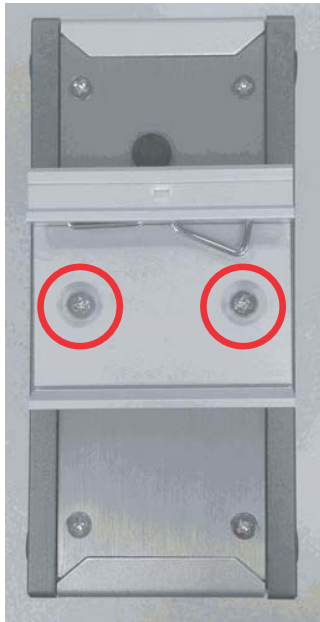

2. Use the 2 included M4-F head screws to fix the DIN rail bracket to the chassis, according to the spacing dimensions of the screw holes and brackets, as shown.

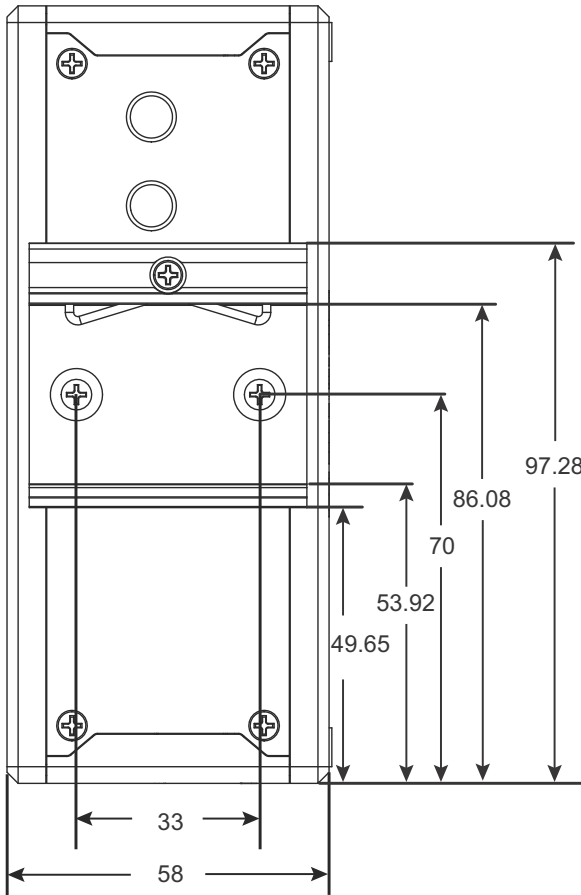

2.8 Wall Mounting



While configuration shown may indicate otherwise, due to the presence of antenna ports, for safety, the device should **ONLY** be wall-mounted with the front and rear panels on the sides, **NEVER** on the top or underside.

Use the 2 M4 screws shipped with the controller to fix the 2 wall-mount brackets, also included, to the chassis, according to the spacing dimensions of the screw holes and brackets.

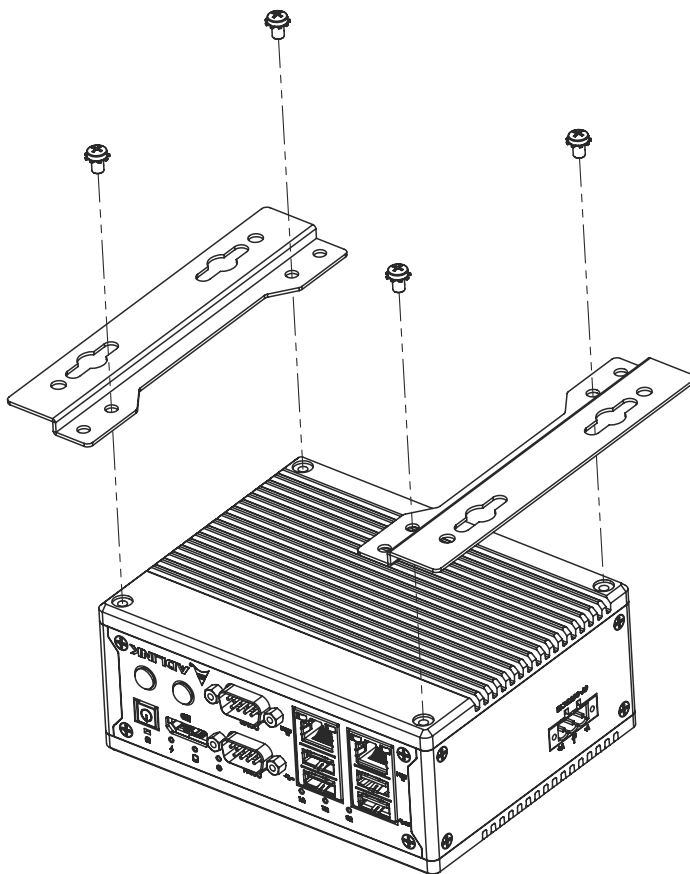

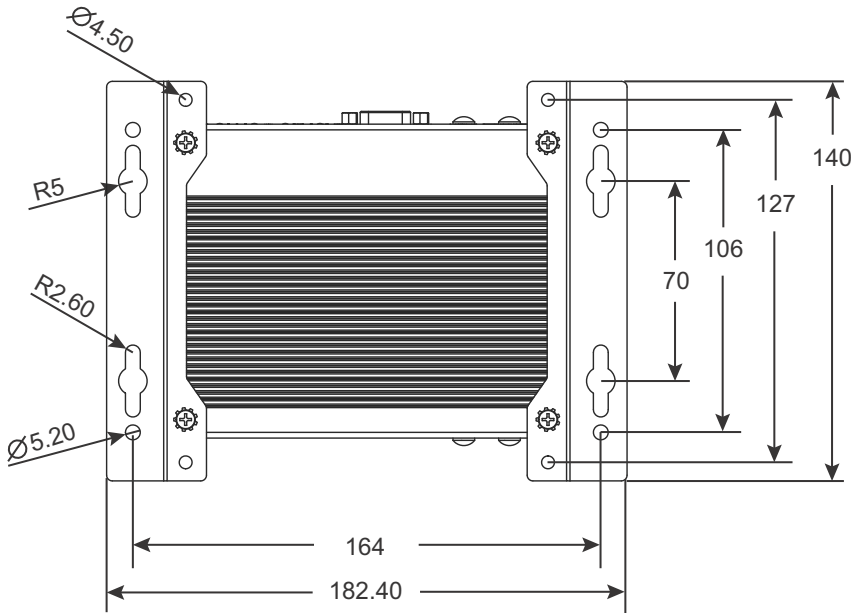

2.9 Cooling Considerations

Heat-generating components of the MXE-210 (such as CPU and PCH) are all situated on the left side of the system. These components directly contact the heat sink via thermal pads and dissipate heat generated by the components. To maximize efficiency of heat dissipation, maintain a minimum of 2 inches (5cm) clearance on the top of the MXE-210.

This page intentionally left blank.

3 Driver & Application Installation

After installing the operating system, all related drivers must be installed for the system to function properly. This section describes the drivers needed for Windows operating systems and the procedures to install them. For other OS support, please contact ADLINK for further information.

Install drivers as follows.

1. Fully install Microsoft Windows OS before installing any drivers. Most standard I/O device drivers have been included in Microsoft Windows OS. For Windows 10 IoT Enterprise users, please note that you need Administrator privilege to install the drivers properly.
2. Install the chipset driver.
3. Install the graphics driver.
4. Install the Ethernet driver.
5. Install the USB 3.0 driver
6. Install the I/O driver.
7. Install the SEMA utility, WDT and DI/O drivers.

3.1 Installing the Chipset Driver

The chipset driver directs the operating system to configure the Intel® chipset components in order to ensure that the following features function properly:

- ▶ SATA Storage Support
- ▶ USB Support
- ▶ Identification of Intel® Chipset Components in the Device Manager

Windows 10 IoT Enterprise must be fully installed and running on the system before installing this software:

To install the chipset driver for the MXE-210

1. Close any running applications.
2. From ADLINK's website, download Windows 10 IoT Enterprise drivers for the MXE-210.
3. Execute Setup.exe and follow onscreen instructions to complete the setup.
4. After installation is complete, reboot the system.

3.2 Installing the Graphics Driver

The MXE-210 is equipped with the Intel® Graphics Media Accelerator Driver package, which supports Windows 10 IoT Enterprise.

To install the graphics driver:

1. Close any running applications.
2. From ADLINK's website, download Windows 10 IoT Enterprise drivers for the MXE-210.
3. Execute Setup.exe and follow onscreen instructions to complete the setup.
4. After installation is complete, reboot the system.

3.3 Installing the Ethernet Driver

To install the driver for the Intel I210 Gigabit Ethernet controller:

1. Close any running applications.
2. From ADLINK's website, download Windows 10 IoT Enterprise drivers for the MXE-210.
3. Execute autorun.exe and follow onscreen instructions to complete the setup.
4. After installation is complete, reboot the system.

3.4 Installing the USB 3.0 Driver

To install the driver for the USB 3.0 controller:

1. Close any running applications.
2. From ADLINK's website, download Windows 10 IoT Enterprise drivers for the MXE-210.
3. Launch setup.exe and follow onscreen instructions to complete the setup.
4. After installation is complete, reboot the system.

3.5 Installing the I/O Driver

To install the driver for the I/O controller:

1. Close any running applications.
2. From ADLINK's website, download Windows 10 IoT Enterprise drivers for the MXE-210.
3. Execute setup.msi and follow onscreen instructions to complete the setup.
4. After installation is complete, reboot the system.

3.6 Installing the SEMA Utility, WDT and DI/O Drivers

The MXE-210 supports ADLINK Smart Embedded Management Utility with features as follows.

- ▶ System Health for real time CPU, system temperature, total/current uptime
- ▶ User-defined 1KB Flash
- ▶ Watchdog Timer
- ▶ Hardware Monitoring for input voltage levels and current power consumption

A WDT (watchdog timer) is a hardware mechanism resetting the system when the operating system or application is halted. A typical usage of WDT is to start the timers and periodically reset the timer, and when timer is expired, the system resets. SEMA utility installation is required to access the WDT function.

To install the SEMA utility, WDT and DI/O drivers:

1. Close any running applications.

From ADLINK's website, download Windows 10 IoT Enterprise drivers for the MXE-210.

2. Execute Setup.exe and follow onscreen instructions to complete the setup.

After installation is complete, reboot the system.



NOTE:

Administrator privilege is required to use the API in Windows 10 IoT Enterprise.

Complete document support for SEMA utility can be found at:

[http://www.adlinktech.com/PD/web/
PD_Manual.php?PDNo=1274&Kind=M&mktg_source=](http://www.adlinktech.com/PD/web/PD_Manual.php?PDNo=1274&Kind=M&mktg_source=)

Appendix A BIOS Setup



NOTE:

BIOS options in the manual are for reference only, and are subject to configuration. Users are welcome to download the latest BIOS version from the ADLINK website.

The Basic Input/Output System (BIOS) is a program that provides a basic level of communication between the processor and peripherals. In addition, the BIOS also contains codes for various advanced features applied to the MXE-210. The BIOS setup program includes menus for configuring settings and enabling features of the MXE-210 series. Most users do not need to use the BIOS setup program, as the MXE-210 ships with default settings that work well for most configurations.



WARNING:

Changing BIOS settings may lead to incorrect controller behavior and possible inability to boot. In such a case, Section 1.5.5 Clear CMOS Jumper on page 18 provides instruction on clearing the CMOS and restoring default settings

A.1 Main

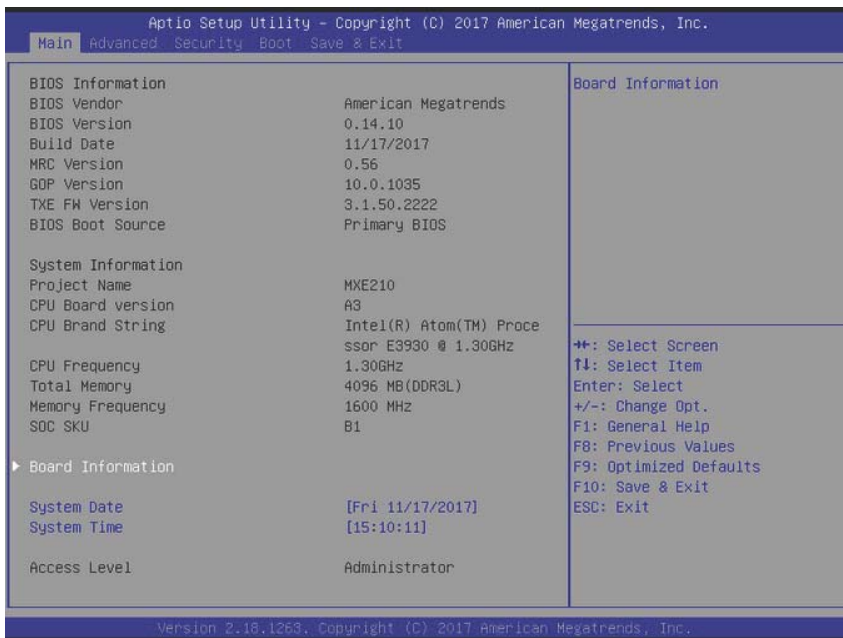

A.1.1 BIOS Information

Shows current system BIOS core version, BIOS version and Board version.

A.1.2 System Time/System Date

Changes system time and date. Highlight System Time or System Date using the up or down <Arrow> keys. Enter new values using the keyboard then <Enter>. Use <Tab > to move between fields. The date must be entered in MM/DD/YY format. The time is entered in HH:MM:SS format.



NOTE:

The time is in 24-hour format, for example, 5:30 A.M. appears as 05:30:00, and 5:30 P.M. as 17:30:00.

A.1.3 Board Information

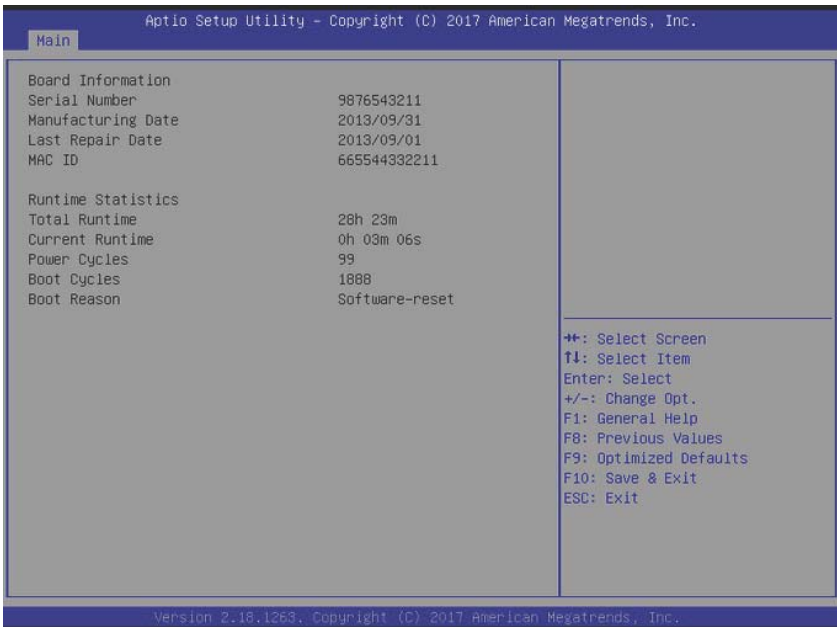

Displays serial number, manufacturing date, last repair date, and MAC ID. As well, Runtime Statistics are listed, including total runtime, current runtime, power cycles, boot cycles, and boot reason.

A.2 Advanced

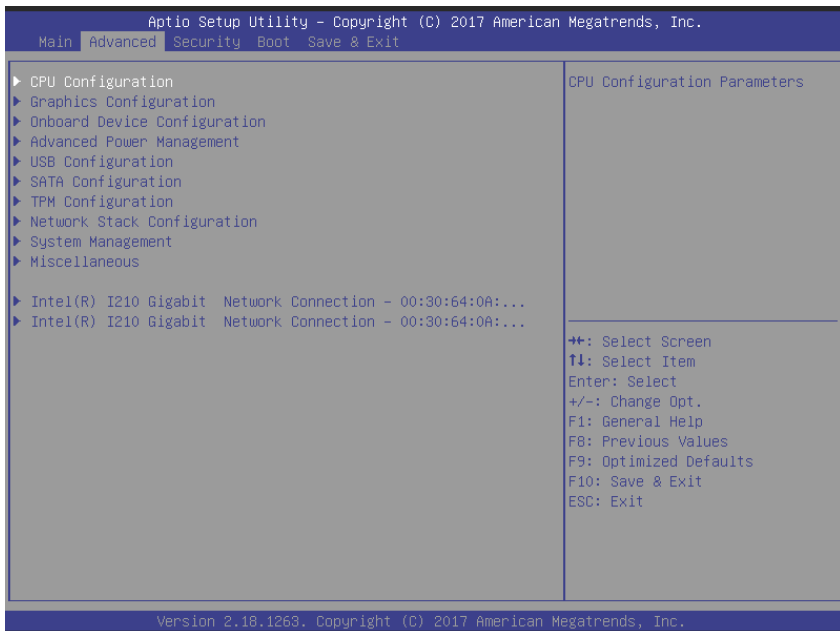

Setting incorrect or conflicting values in Advanced BIOS Setup may cause system malfunction.

A.2.1 CPU Configuration



Active Processor Cores

Number of cores to enable in each processor package.

Intel Virtualization Technology

When enabled, allows a VMM to utilize the additional hardware capabilities provided by Vanderpool Technology

VT-d

Enables/disables CPU VT-d

Turbo Mode

Enables/disables Turbo Mode.

Critical Trip Point

Temperature threshold of the Critical Trip Point.

Passive Cooling Trip Point

Temperature threshold of the Passive Cooling Trip Point.

A.2.2 Graphics Configuration

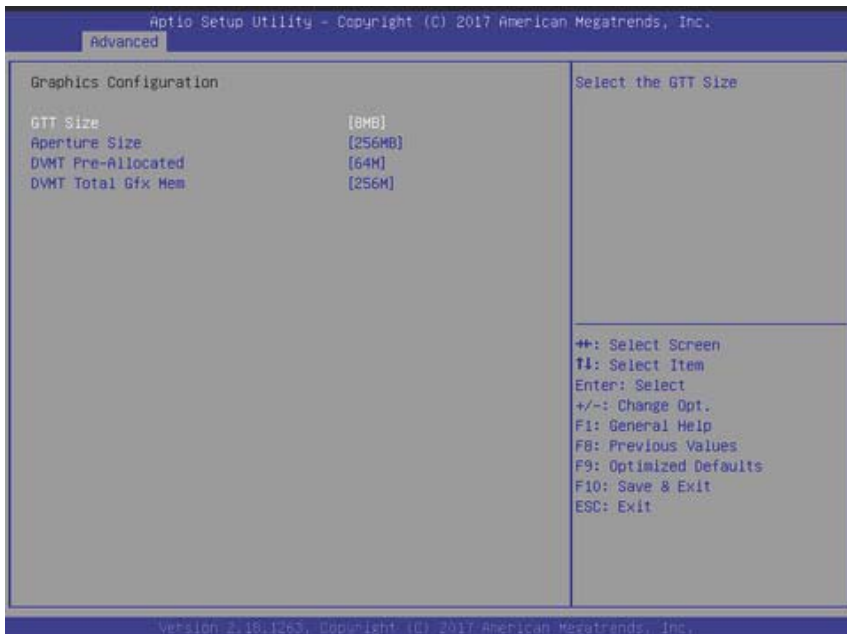

GTT Size

Sets GTT size

Aperture Size

Sets aperture size

DVMT Pre-Allocated

Sets size of DVMT 5.0 pre-allocated (fixed) graphics memory used by internal graphics device

DVMT Total Gfx Mem

Sets size of DVMT5.0 total graphic memory used by internal graphics device

A.2.3 Onboard Device Configuration

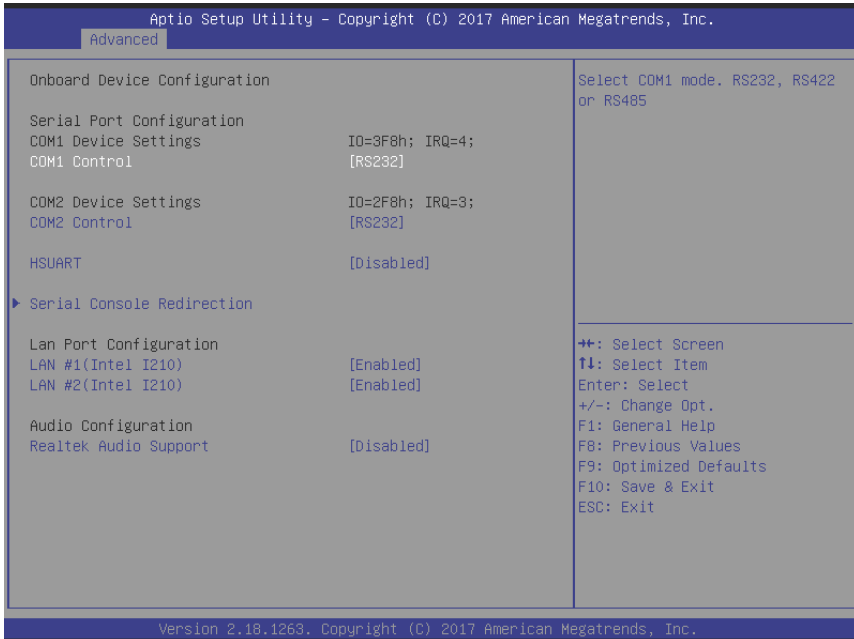

COM1 Control

Selects COM1 mode from among RS232, RS422, and RS485.

COM2 Control

Selects COM2 mode from among RS232, RS422, and RS485.

HSUART

Enables/disables LPSS HSUART support.

LAN #1 (Intel I210)

Enables/disables LAN device #1.

LAN #2 (Intel I210)

Enables/disables LAN device #2.

Realtek Audio Support

Enables/disables Realtek audio device.

Serial Console Redirection

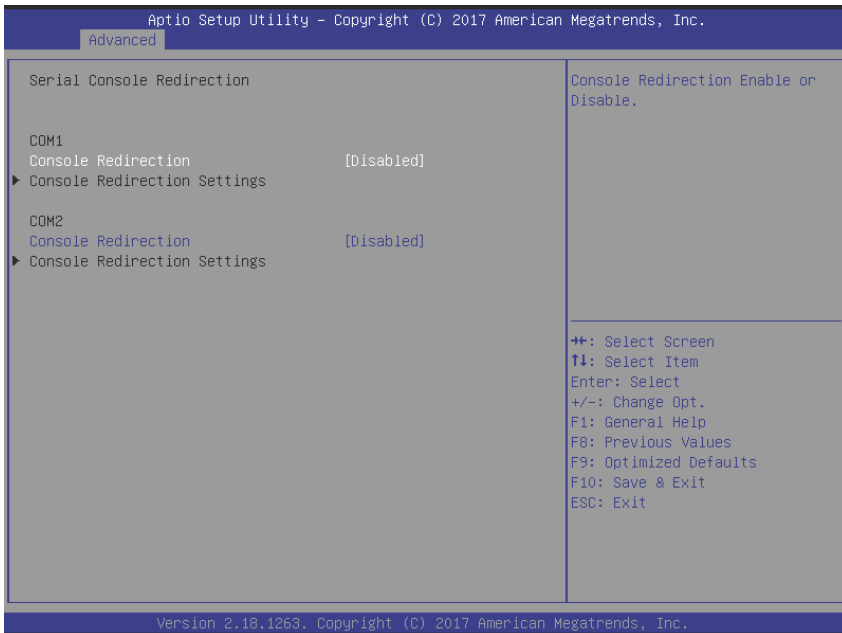

COM 1

Console Redirection

Enables/Disables COM 1 console redirection.

Console Redirection Settings (COM 1)

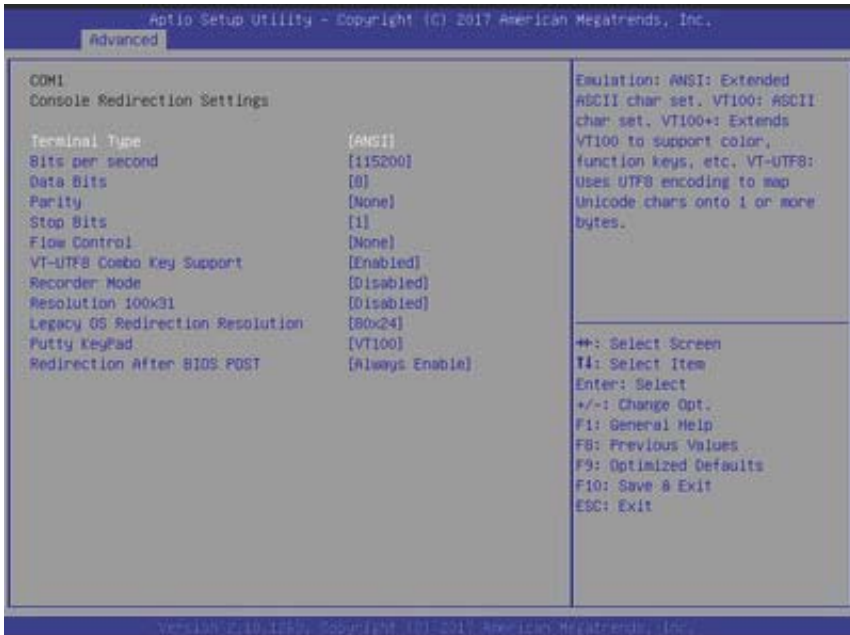

Terminal Type

Emulation:

ANSI: Extended ASCII char set.

VT100: ASCII char set.

VT100+: Extends VT100 to support color, function keys, etc.

VT-UTF8: Uses UTF8 encoding to map Unicode chars onto 1 or more bytes.

Bits per second

Selects serial port transmission speed, which must be matched on the other side, where long or noisy lines may require lower speeds.

Data Bits

Number of data bits

Parity

Parity bit can be sent with data bits to detect transmission errors, where

Even: parity bit is 0 if the number of 1's in the data bits is even

Odd: parity bit is 0 if number of 1's in the data bits is odd.

Mark: parity bit is always 1.

Space: Parity bit is always 0.

Mark and Space Parity do not allow for error detection, and can be used as an additional data bit.

Stop Bits

Indicate the end of a serial data packet (a start bit indicates the beginning), with standard setting 1 stop bit, and communication with slow devices may require more than 1 stop bit.

Flow Control

Can prevent data loss from buffer overflow, where, when sending data, if the receiving buffers are full, a 'stop' signal can be sent to stop the data flow, and once buffers are empty, a Start signal can be sent to re-start the flow. Hardware flow control uses two wires to send start/stop signals.

VT-UTF8 Combo Key Support

Enables VT-UTF8 Combination Key Support for ANSI/VT100 terminals

Recorder Mode

When enabled, only text will be sent, to capture terminal data.

Resolution 100x31

Enables/disables extended terminal resolution

Legacy OS Redirection Resolution

In legacy OS, the number of rows and columns supporting redirection

Putty KeyPad

Selects FunctionKey and KeyPad on PuTTY

Redirection After BIOS Post

When Bootloader is selected, Legacy Console Redirection is disabled before booting to legacy OS.

When Always Enable is selected, Legacy Console Redirection is enabled for legacy OS.

Default is set to Always Enable.

COM 2

Console Redirection

Enables/Disables COM 2 console redirection.

Console Redirection Settings (COM 2)

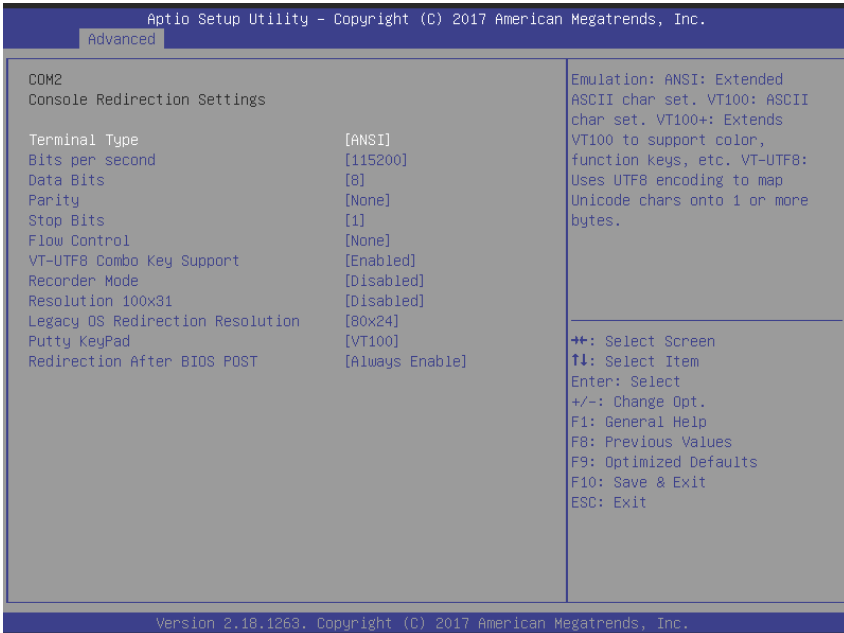

Terminal Type

Emulation:

ANSI: Extended ASCII char set.

VT100: ASCII char set.

VT100+: Extends VT100 to support color, function keys, etc.

VT-UTF8: Uses UTF8 encoding to map Unicode chars onto 1 or more bytes.

Bits per second

Selects serial port transmission speed, which must be matched on the other side, where long or noisy lines may require lower speeds.

Data Bits

Number of data bits

Parity

Parity bit can be sent with data bits to detect transmission errors, where

Even: parity bit is 0 if the number of 1's in the data bits is even

Odd: parity bit is 0 if number of 1's in the data bits is odd.

Mark: parity bit is always 1.

Space: Parity bit is always 0.

Mark and Space Parity do not allow for error detection, and can be used as an additional data bit.

Stop Bits

Indicate the end of a serial data packet (a start bit indicates the beginning), with standard setting 1 stop bit, and communication with slow devices may require more than 1 stop bit.

Flow Control

Can prevent data loss from buffer overflow, where, when sending data, if the receiving buffers are full, a 'stop' signal can be sent to stop the data flow, and once buffers are empty, a Start signal can be sent to re-start the flow. Hardware flow control uses two wires to send start/stop signals.

VT-UTF8 Combo Key Support

Enables VT-UTF8 Combination Key Support for ANSI/VT100 terminals

Recorder Mode

When enabled, only text will be sent, to capture terminal data.

Resolution 100x31

Enables/disables extended terminal resolution

Legacy OS Redirection Resolution

In legacy OS, the number of rows and columns supporting redirection

Putty KeyPad

Selects FunctionKey and KeyPad on PuTTY

Redirection After BIOS Post

When Bootloader is selected, Legacy Console Redirection is disabled before booting to legacy OS.

When Always Enable is selected, Legacy Console Redirection is enabled for legacy OS.

Default is set to Always Enable.

A.2.4 Advanced Power Management

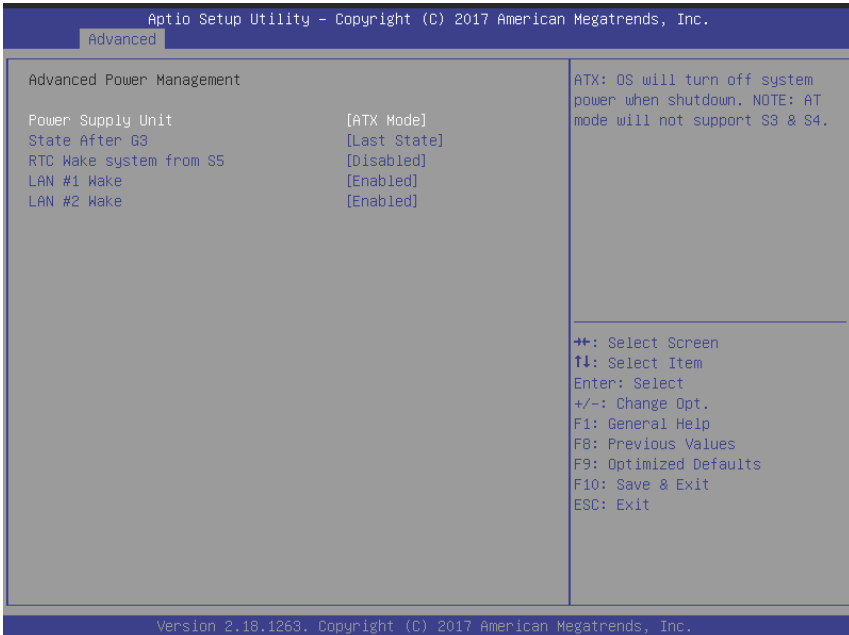

Power Supply Unit

ATX: OS will turn off system power when shutdown, where AT mode does not support S3 & S4.

State After G3

Specifies state to enter when power is re-applied after a power failure (G3 state).

RTC Wake system from S5

Enables/disables System Wake on alarm event, where selecting FixedTime wakes system at hr::min::sec specified, and Dynamic-Time wakes system at the current time + Increase minute(s) specified

LAN #1 Wake

Enables/disables onboard Wake on LAN for #1

LAN #2 Wake

Enables/disables onboard Wake on LAN for #2

A.2.5 USB Configuration

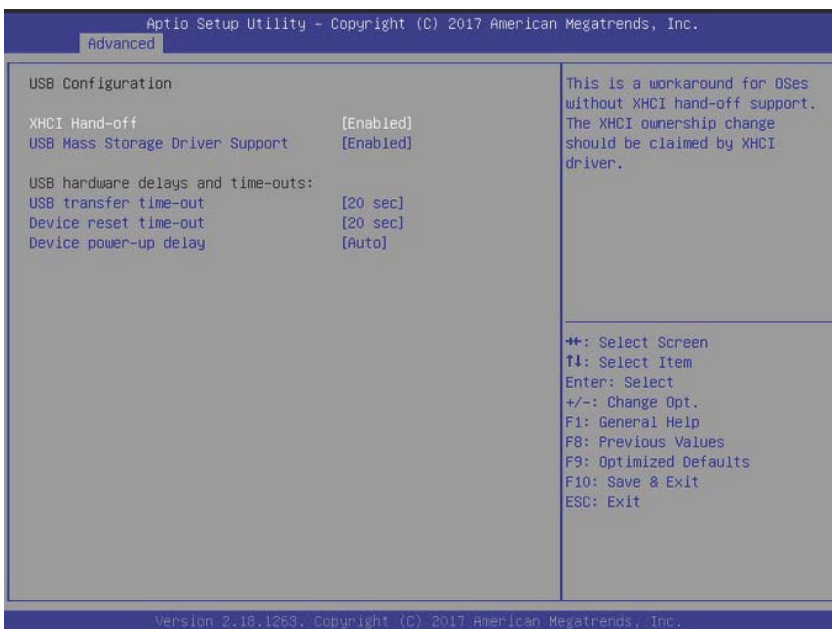

XHCI Hand-off

A workaround for OS without XHCI handoff support, where XHCI ownership change should be claimed by the XHCI driver.

USB Mass Storage Driver Support

Enables/disables USB mass storage driver support.

USB transfer time-out

Timeout value for Control, Bulk, and Interrupt transfers.

Device reset time-out

USB mass storage device Start Unit command timeout.

Device power-up delay

Maximum time the device will take before reporting to the Host Controller, where Auto uses default value, for a Root port 100 ms, and for a Hub port the delay is taken from the Hub descriptor.

A.2.6 SATA Configuration



Port

Enables/disables SATA Port

A.2.7 TPM Configuration



Security Device Support

Enables/disables BIOS support for security device, when enabled, OS will not show the security device, and TCG EFI protocol and INT1A interface will not be available.

A.2.8 Network Stack Configuration

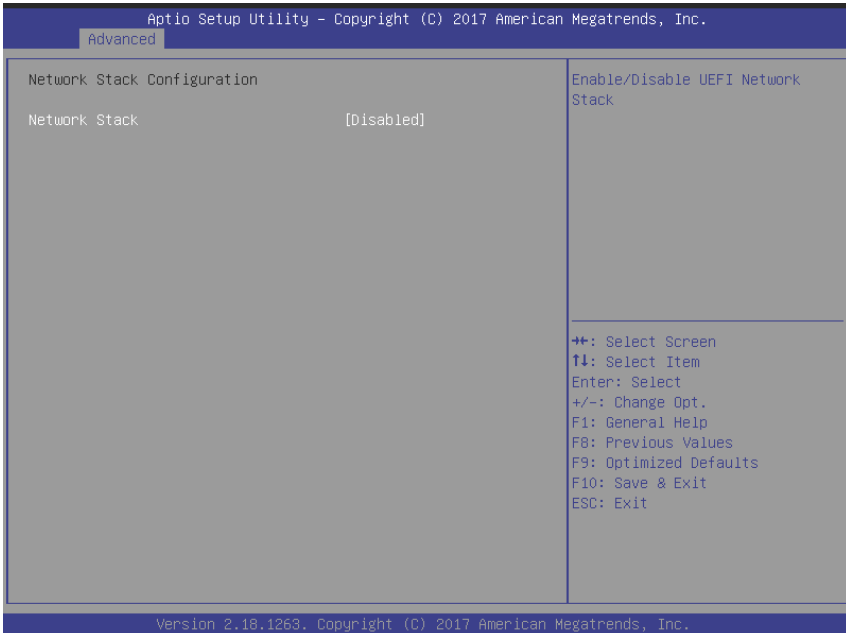

Network Stack

Enables/disables UEFI network stack

A.2.9 System Management

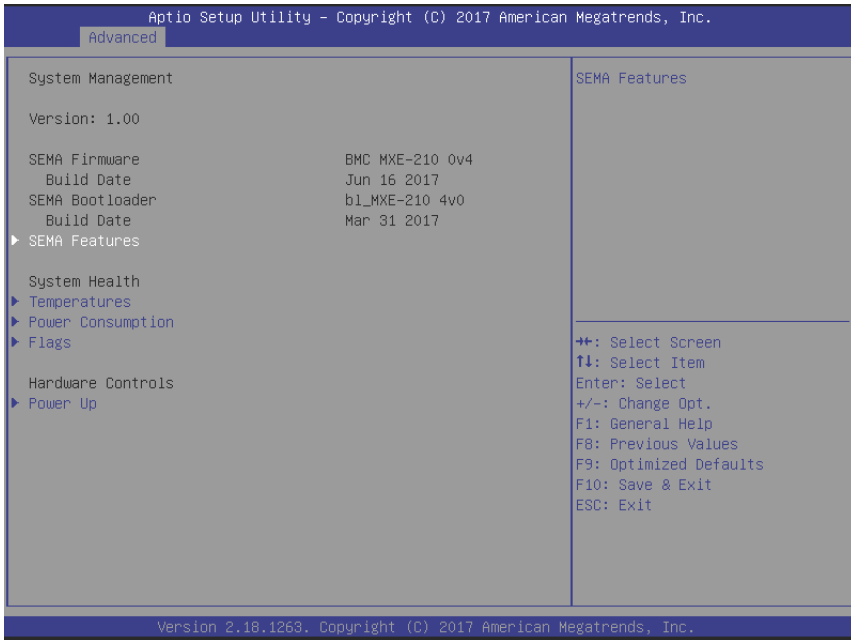

Shows SEMA firmware and bootloader versions and build dates.

SEMA Features

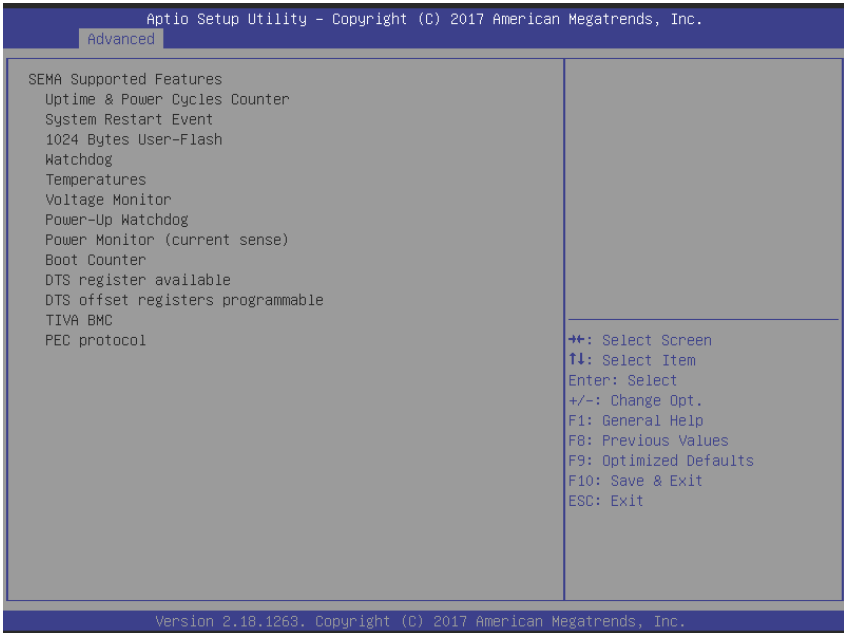

Shows features supported by the SEMA version.

Temperatures

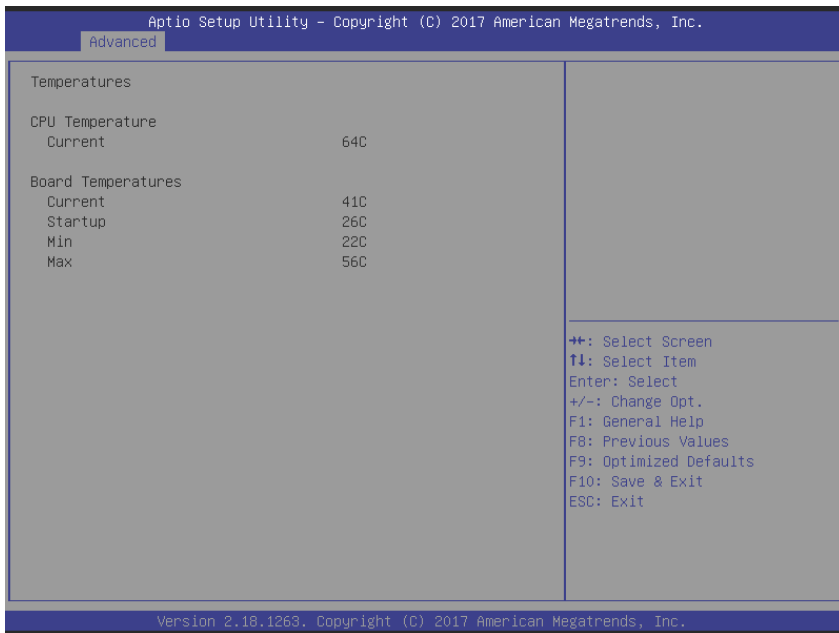

Shows current CPU temperature, and current, startup, minimum, and maximum board temperatures.

Power Consumption

The screenshot shows the 'Advanced' menu of the Aptio Setup Utility. The 'Power Consumption' section is selected, displaying a list of power-related metrics and their values. A legend on the right side of the screen provides navigation instructions for the BIOS interface.

Parameter	Value
Current Input Current	0.200A
Current Input Power	1.000W
V _{CCORE}	0.909V
V _{GFX}	0.880V
V _{1P05S}	1.041V
V _{1P35}	1.332V
V _{RTC}	3.041V
V _{3P3S}	3.303V
V _{3P3A}	3.307V
V _{IN}	4.989V
V _{1P24A}	1.235V
V _{1P8A}	1.793V
V _{5_SBY}	4.965V

Legend:

- : Select Screen
- ↑↓: Select Item
- Enter: Select
- +/-: Change Opt.
- F1: General Help
- F8: Previous Values
- F9: Optimized Defaults
- F10: Save & Exit
- ESC: Exit

Version 2.18.1263. Copyright (C) 2017 American Megatrends, Inc.

Shows current input current and power, as well as system voltages.

Flags

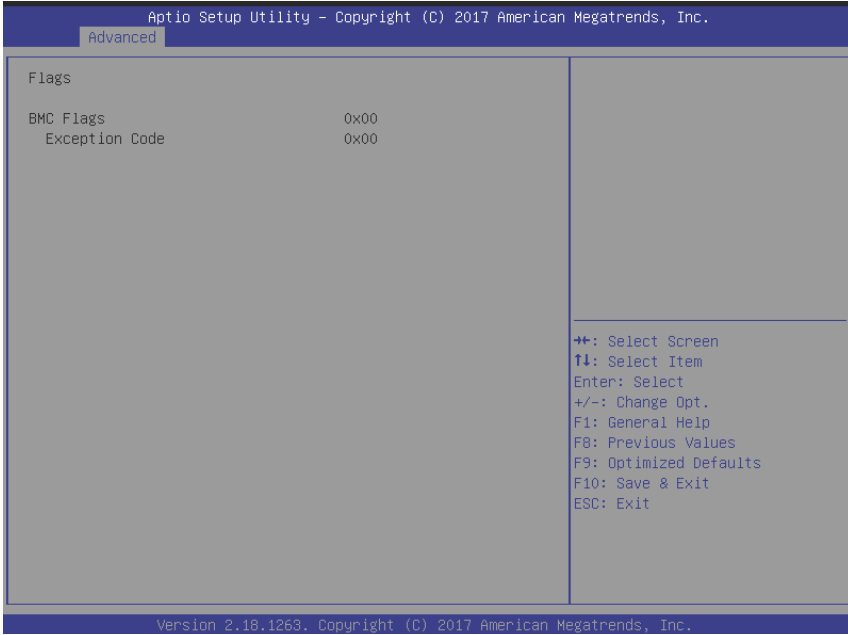

Shows BMC flags with exception codes.

Power Up

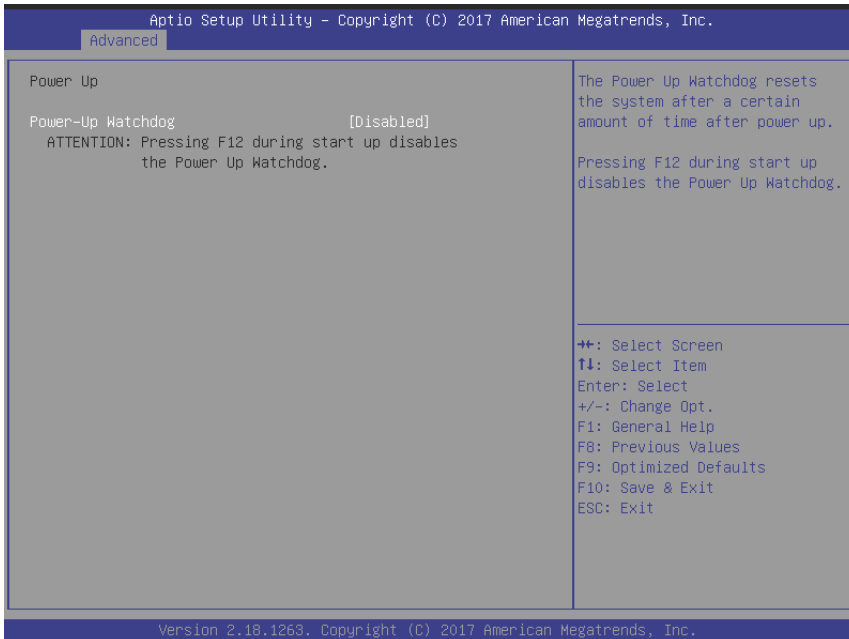

Lists Power-Up Watchdog status.

A.2.10 Miscellaneous

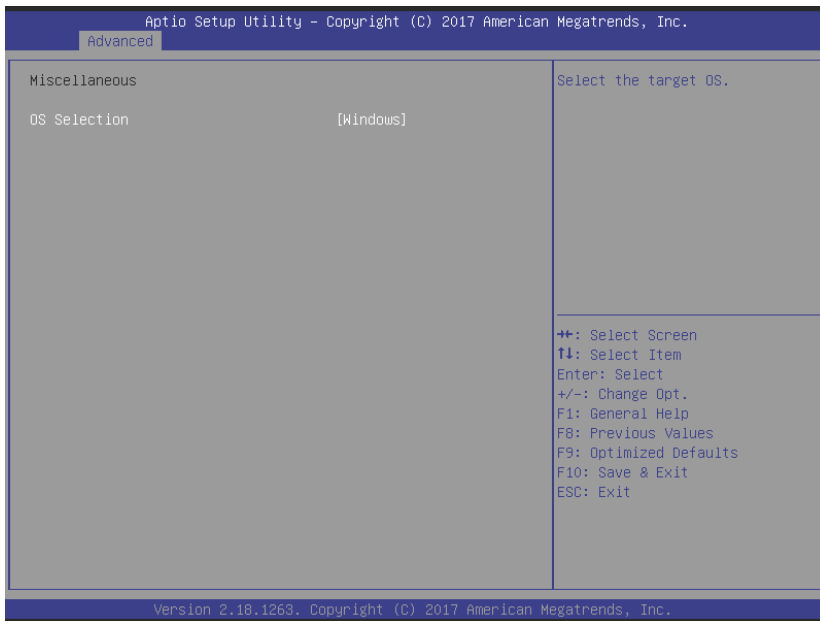

OS Selection

Allows selection of active OS.

A.2.11 Intel® I210 Gigabit Network Connection

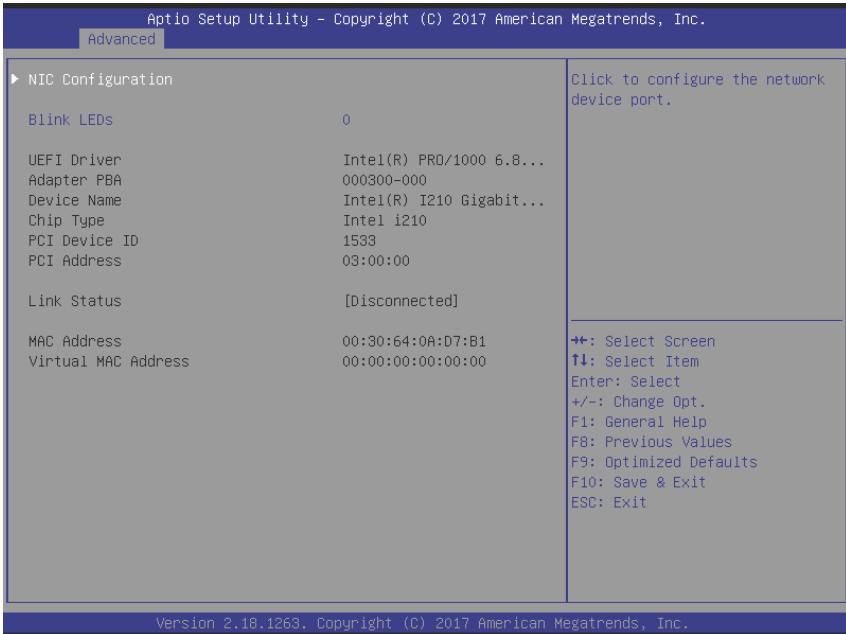

Blink LEDs

Identifies the physical network port by flashing the associated LED.

A.2.12 NIC Configuration

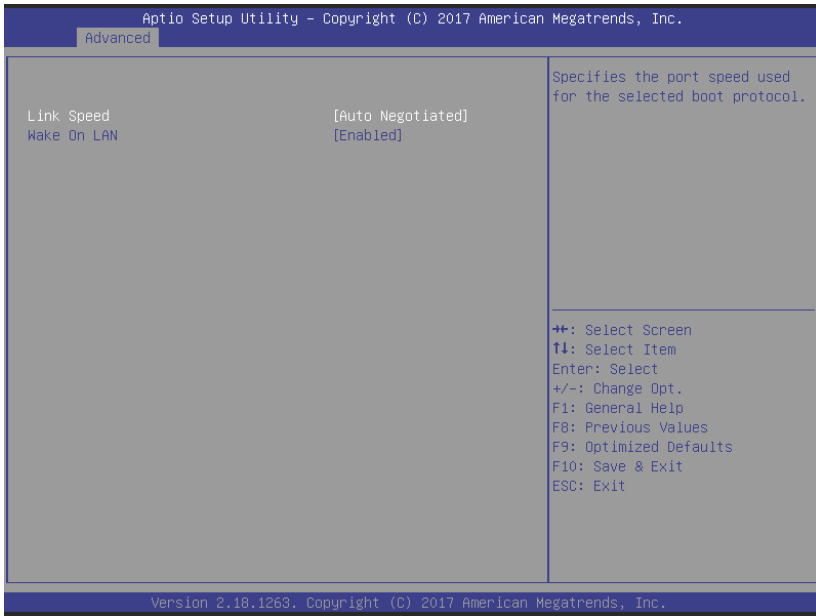

Link Speed

Specifies the port speed used for the selected boot protocol.

Wake On LAN

Enables server power-up using an in-band magic packet.

A.3 Security

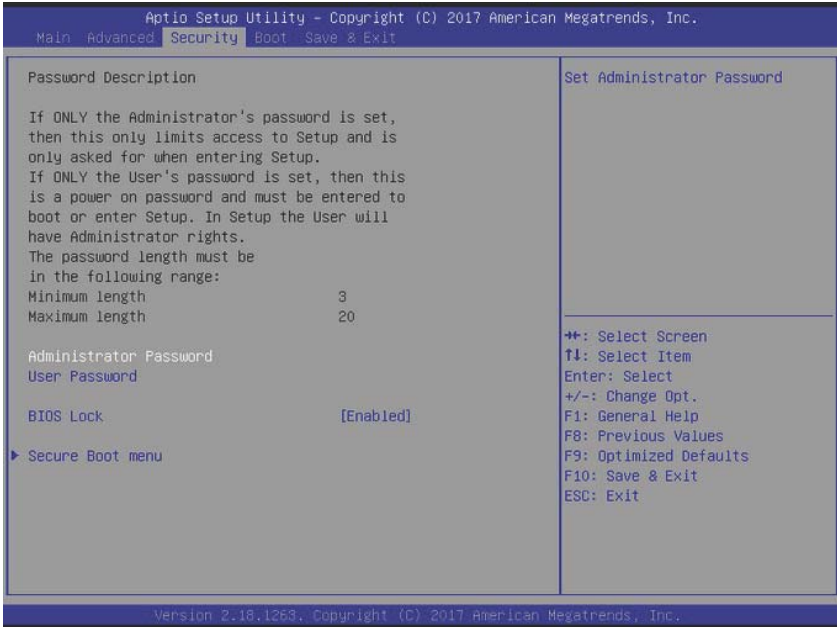

NOTE:

If only the Administrator's password is set, only access to Setup is limited and authorization requested only when entering Setup. If only the User's password is set, a password must be entered to boot or enter setup. In Setup the user has Administrator rights.

Administrator Password

Sets Administrator password.

User Password

Sets User password.

BIOS Lock

Enables/disables SC BIOS Lock, which must be enabled to ensure SMM flash protection.

A.3.1 Secure Boot

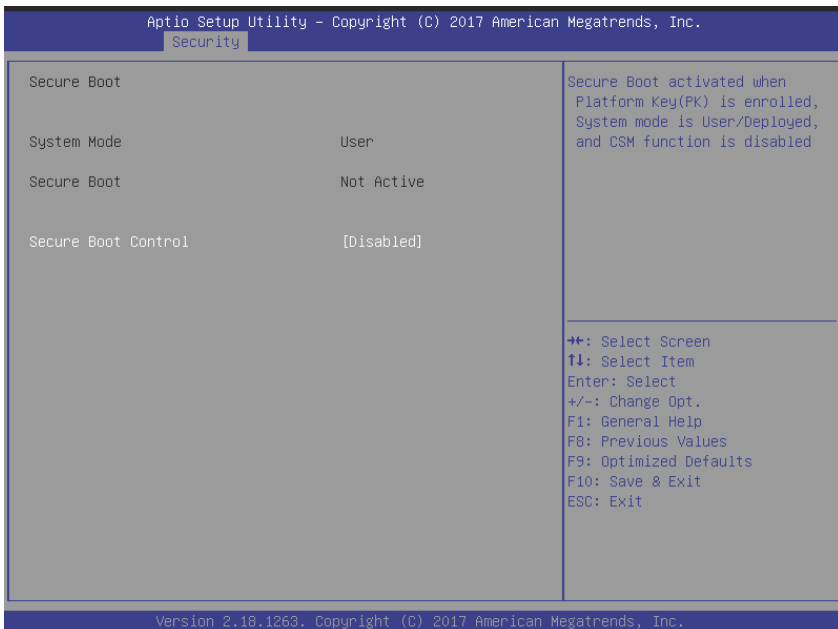

Shows System Mode and Secure Boot status.



NOTE:

Secure Boot is activated when Platform Key (PK) is enrolled, where System Mode is User/Deployed, and CSM function is disabled.

A.4 Boot

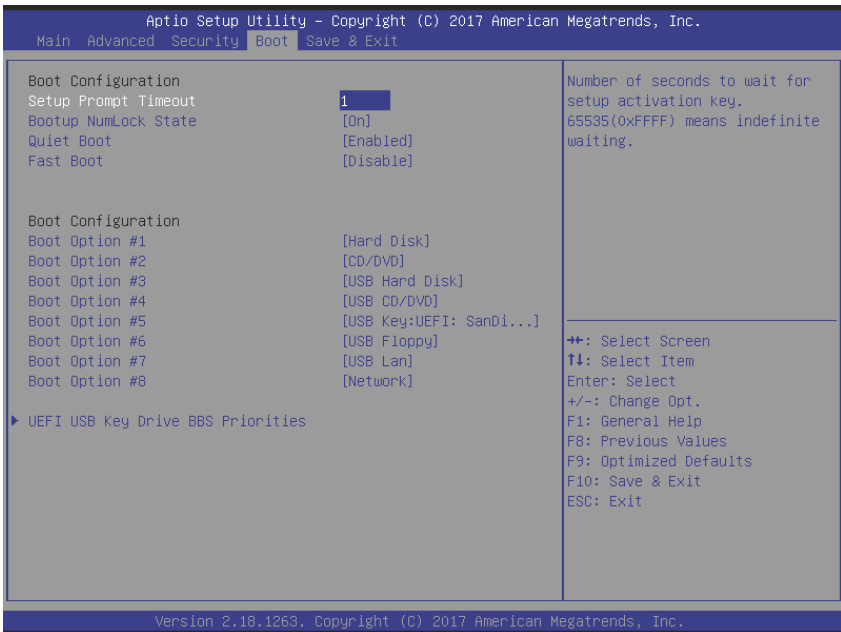

Setup Prompt Timeout

Number of seconds to wait for setup activation key, with 65535(0xFFFF) indicating infinite wait.

Bootup NumLock State

Sets keyboard NumLock status

Quiet Boot

Enables/disables Quiet Boot option

Fast Boot

Enables/disables boot with the minimal device initialization required to launch active boot option, with no effect on BBS boot options.

Sets number of seconds to wait for setup activation key.

Boot Option Priorities

Specifies the priority of boot devices, with all installed boot devices detected during POST and displayed, where selecting Boot Option # specifies the desired boot device.

A.5 Save & Exit

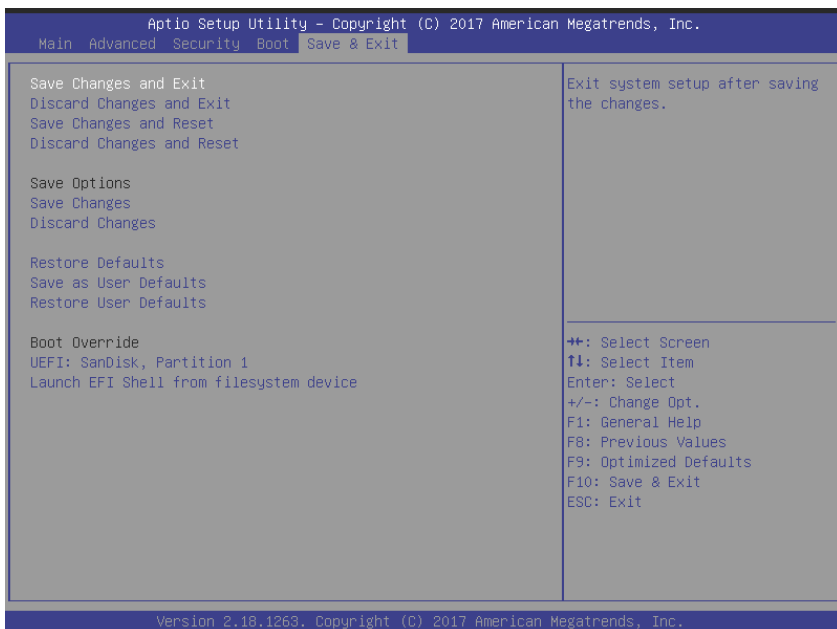

Save Changes and Exit

Exits system setup after saving the changes.

Discard Changes and Exit

Exits system setup without saving any changes.

Save Changes and Reset

Resets the system after saving changes.

Discard Changes and Reset

Resets system setup without saving any changes.

Save Changes

Saves changes to any setup options.

Discard Changes

Discards changes to any of the setup options.

Restore Defaults

Restores/loads default values for all setup options.

Save as User Defaults

Saves changes as User Defaults.

Restore User Defaults

Restores User Defaults to all setup options.

Launch EFI Shell from filesystem device

Attempts to launch EFI Shell application (Shell.efi) from one of the available filesystem devices.

This page intentionally left blank.

Important Safety Instructions

For user safety, please read and follow all instructions, Warnings, Cautions, and Notes marked in this manual and on the associated device before handling/operating the device, to avoid injury or damage.

S'il vous plaît prêter attention stricte à tous les avertissements et mises en garde figurant sur l'appareil , pour éviter des blessures ou des dommages.

- ▶ Read these safety instructions carefully
- ▶ Keep the User's Manual for future reference
- ▶ Read the Specifications section of this manual for detailed information on the recommended operating environment
- ▶ The device can be operated at an ambient temperature of 50°C
- ▶ When installing/mounting or uninstalling/removing device; or when removal of a chassis cover is required for user servicing (See "Getting Started" on page 33.):
 - ▷ Turn off power and unplug any power cords/cables
 - ▷ Reinstall all chassis covers before restoring power
- ▶ To avoid electrical shock and/or damage to device:
 - ▷ Keep device away from water or liquid sources
 - ▷ Keep device away from high heat or humidity
 - ▷ Keep device properly ventilated (do not block or cover ventilation openings)
 - ▷ Always use recommended voltage and power source settings
 - ▷ Always install and operate device near an easily accessible electrical outlet
 - ▷ Secure the power cord (do not place any object on/over the power cord)
 - ▷ Only install/attach and operate device on stable surfaces and/or recommended mountings
- ▶ If the device will not be used for long periods of time, turn off and unplug from its power source

- ▶ Never attempt to repair the device, which should only be serviced by qualified technical personnel using suitable tools
- ▶ A Lithium-type battery may be provided for uninterrupted backup or emergency power.



Risk of explosion if battery is replaced with one of an incorrect type; please dispose of used batteries appropriately.

Risque d'explosion si la pile est remplacée par une autre de type incorrect. Veuillez jeter les piles usagées de façon appropriée.

- ▶ The device must be serviced by authorized technicians when:
 - ▷ The power cord or plug is damaged
 - ▷ Liquid has entered the device interior
 - ▷ The device has been exposed to high humidity and/or moisture
 - ▷ The device is not functioning or does not function according to the User's Manual
 - ▷ The device has been dropped and/or damaged and/or shows obvious signs of breakage
- ▶ Disconnect the power supply cord before loosening the thumbscrews and always fasten the thumbscrews with a screwdriver before starting the system up
- ▶ It is recommended that the device be installed only in a server room or computer room where access is:
 - ▷ Restricted to qualified service personnel or users familiar with restrictions applied to the location, reasons therefor, and any precautions required
 - ▷ Only afforded by the use of a tool or lock and key, or other means of security, and controlled by the authority responsible for the location

	<p>BURN HAZARD</p> <p>Touching this surface could result in bodily injury. To reduce risk, allow the surface to cool before touching.</p> <p><i>RISQUE DE BRÛLURES</i></p> <p><i>Ne touchez pas cette surface, cela pourrait entraîner des blessures.</i></p> <p><i>Pour éviter tout danger, laissez la surface refroidir avant de la toucher.</i></p>
---	--

This page intentionally left blank.

Getting Service

Ask an Expert: <http://askanexpert.adlinktech.com>

ADLINK Technology, Inc.

9F, No.166 Jian Yi Road, Zhonghe District
New Taipei City 235, Taiwan
Tel: +886-2-8226-5877
Fax: +886-2-8226-5717
Email: service@adlinktech.com

Ampro ADLINK Technology, Inc.

5215 Hellyer Avenue, #110
San Jose, CA 95138, USA
Tel: +1-408-360-0200
Toll Free: +1-800-966-5200 (USA only)
Fax: +1-408-360-0222
Email: info@adlinktech.com

ADLINK Technology (China) Co., Ltd.

300 Fang Chun Rd., Zhangjiang Hi-Tech Park
Pudong New Area, Shanghai, 201203 China
Tel: +86-21-5132-8988
Fax: +86-21-5132-3588
Email: market@adlinktech.com

LiPERT ADLINK Technology GmbH

Hans-Thoma-Strasse 11
D-68163 Mannheim, Germany
Tel: +49-621-43214-0
Fax: +49-621 43214-30
Email: emea@adlinktech.com

Please visit the Contact page at **www.adlinktech.com** for information on how to contact the ADLINK regional office nearest you: