

# Neosys Technology Inc.

## Nuvo-6000 Series

***Intel® 6th-Gen Skylake Core™ i7/i5 Fanless Box-PC with  
Multiple PCIe/PCI Expansion Slots***

***Nuvo-6032 / Nuvo-6002***

## User's Manual

**Rev. A2**

Published Feb 17<sup>th</sup>, 2017



## Contents

Disclaimer.....	6
Declaration of Conformity.....	6
FCC.....	6
CE.....	6
Copyright and Trademarks.....	6
Chapter 1 Introduction.....	7
1.1 Overview.....	7
1.2 Product Specification.....	8
1.2.1 Specification of Nuvo-6032.....	8
1.2.2 Specification of Nuvo-6002.....	10
Chapter 2 Getting to know your Nuvo-6000.....	12
2.1 Unpacking your Nuvo-6000.....	12
2.2 Front Panel I/O Functions.....	13
2.2.1 Power Button.....	13
2.2.2 Reset Button.....	13
2.2.3 Speaker-Out Jack.....	14
2.2.4 LED Indicators.....	14
2.2.5 USB 3.0 Connectors.....	15
2.2.6 Gigabit Ethernet Port.....	15
2.2.7 DVI-D Connector.....	16
2.2.8 COM Ports (COM1/COM2).....	17
2.2.9 COM Ports (COM3/COM4/COM5).....	18
2.2.10 3-Pin Terminal Block for DC Input.....	19
2.3 Internal I/O Functions.....	20
2.3.1 Status LED Output & Remote On/Off Control.....	20
2.3.2 DDR4 SODIMM Socket.....	22
2.3.3 Internal USB 2.0 Box Header.....	23
2.3.4 mSATA Socket.....	24
2.3.5 SATA #1 Port.....	25
2.3.6 SATA #2 and SATA #3 Ports (Nuvo-6032 Only).....	26
2.3.7 12 VDC PCIe Power Connector.....	27
2.3.8 Internal USB Port.....	28
2.3.9 PCI Express Slots.....	29
2.3.10 PCI Slots (Nuvo-6032 Only).....	30
2.4 Mechanical Dimension.....	31
2.4.1 Front View of Nuvo-6032.....	31
2.4.2 Back View of Nuvo-6032.....	32
2.4.3 Top View of Nuvo-6032.....	33



2.4.4 Bottom View of Nuvo-6032.....	34
2.4.5 Right View of Nuvo-6032.....	35
2.4.6 Left View of Nuvo-6032.....	35
2.4.7 Front View of Nuvo-6002.....	36
2.4.8 Back View of Nuvo-6002.....	37
2.4.9 Top View of Nuvo-6002.....	38
2.4.10 Bottom View of Nuvo-6002.....	39
2.4.11 Right View of Nuvo-6002.....	40
2.4.12 Left View of Nuvo-6002.....	40
Chapter 3 Getting Start.....	41
3.1 Disassemble your Nuvo-6000 Controller.....	41
3.1.1 Remove the Chassis Cover.....	41
3.1.2 Disassemble the SBC of Nuvo-6000.....	42
3.2 Install and Replace a LGA1151 CPU.....	44
3.2.1 Install a CPU on Nuvo-6000.....	44
3.2.2 Replace the CPU on Nuvo-6000.....	48
3.3 Install DDR4 SODIMM Module.....	51
3.4 Install mSATA SSD.....	52
3.5 Install 2.5" HDD/SSD.....	53
3.5.1 Install 2.5" HDD/SSD to SATA Port #1.....	53
3.5.2 Install 2.5" HDD/SSD to SATA Port #2 & #3 (Nuvo-6032 Only).....	54
3.6 Install PCI/PCIe Add-on Card.....	56
3.7 Install Optional Fan.....	58
3.8 Mount your Nuvo-6000.....	60
3.8.1 Mount your Nuvo-6032 on the Wall.....	60
3.8.2 Mount your Nuvo-6032 on a Flat Surface.....	61
3.8.3 Mount your Nuvo-6032 on the DIN Rail.....	62
3.8.4 Mount your Nuvo-6032 into a Rack.....	63
3.8.5 Mount your Nuvo-6002 on the Wall.....	65
3.8.6 Mount your Nuvo-6002 on a Flat Surface.....	66
3.8.7 Mount your Nuvo-6002 on a DIN Rail.....	67
3.8.8 Mount your Nuvo-6002 into a Rack.....	68
3.9 Connect DC power to you Nuvo-6000.....	70
3.10 Power on your Nuvo-6000.....	71
3.10.1 Power on Nuvo-6000 Using the Power Button.....	71
3.10.2 Power on Nuvo-6000 Using Wake-on-LAN Function.....	71
Chapter 4 BIOS and Driver.....	74
4.1 BIOS Settings.....	74
4.1.1 COM1 & COM2 Operating Mode.....	74
4.1.2 Set Link Speed for x16 PCIe Slot.....	75



4.1.3 Set Link Speed for x8 PCIe Slot.....	76
4.1.4 Set Trip Points for Optional Fan.....	77
4.1.5 Configure CPU SKU Power.....	78
4.1.6 Wake-on-LAN Option.....	79
4.1.7 Power On after Power Failure Option.....	80
4.1.8 Configure Legacy/UEFI Boot Type.....	81
4.1.9 Position New Boot Device.....	82
4.1.10 Watchdog Timer for Booting.....	83
4.1.11 Select a Boot Device.....	85
4.2 Operating System Support.....	86
4.3 Driver Installation.....	87
4.3.1 Install All Drivers Using “One-Click” Driver Installation.....	87
4.3.2 Install Drivers Manually.....	88
4.3.3 Install Driver for WDT Function.....	90
Appendix A Install Windows 7 on Nuvo-6000.....	91
A.1 Before We Start .....	91
A.2 Create USB Flash Drive Installer Step-by-Step.....	91
Step 1 - Create .ISO file from Windows 7 DVD.....	91
Step 2 - Create USB flash drive installer from .ISO.....	92
Step 3 - Create working folder on your local drive.....	93
Step 4 - Execute batch file to patch .wim files.....	94
Step 5 - Install Windows 7 using USB flash drive installer.....	95
Appendix B Using Watchdog Timer.....	97
Install WDT_DIO Library.....	97
WDT Function Reference.....	100



## Revision History

Date	Change List	Version
2016/11/4	First formal release	A1
2017/2/17	Correct typos and pin definition of <ul style="list-style-type: none"> <li>- Specification of internal 16-pin USB 2.0 box header (page 8 &amp; page 10)</li> <li>- Description of color of GbE LED indicator (page 15)</li> <li>- Pin definition of COM1/COM2 connector for RS-422/485 mode (page 17)</li> <li>- Pin definition of status LED output &amp; remote on/off control pin header (page 20)</li> <li>- Description of internal USB 2.0 box header (page 23)</li> </ul>	A2



# Disclaimer

This manual is intended to be used as a practical and informative guide only and is subject to change without prior notice. It does not represent commitment from Neosys Technology Inc. Neosys shall not be liable for direct, indirect, special, incidental, or consequential damages arising out of the use of the product or documentation, nor for any infringements upon the rights of third parties, which may result from such use.

# Declaration of Conformity

## FCC

This equipment has been tested and found to comply with the limits for a Class A digital device, pursuant to part 15 of the FCC Rules. These limits are designed to provide reasonable protection against harmful interference when the equipment is operated in a commercial environment. This equipment generates, uses, and can radiate radio frequency energy and, if not installed and used in accordance with the instruction manual, may cause harmful interference to radio communications. Operation of this equipment in a residential area is likely to cause harmful interference in which case the user will be required to correct the interference at his own expense.

## CE

The product(s) described in this manual complies with all applicable European Union (CE) directives if it has a CE marking. For computer systems to remain CE compliant, only CE-compliant parts may be used. Maintaining CE compliance also requires proper cable and cabling techniques.

# Copyright and Trademarks

This document contains proprietary information protected by copyright. All rights are reserved. No part of this document may be reproduced by any mechanical, electronic, or other means in any form without prior written permission of the manufacturer.

Company/product names mentioned herein are used for identification purposes only and are trademarks and/or registered trademarks of their respective companies.



# Chapter 1 Introduction

## 1.1 Overview.

Nuvo-6000 series is the perfect replacement of your bulky rack-mount or wall-mount IPC systems. Leveraging 6th-Gen Intel® Skylake platform, It delivers the same computing power as traditional IPCs, but in a more compact form-factor and fanless operation.

Nuvo-6000 series supports LGA1151 socket-type CPU, thus you can choose from Core™ i7 to Celeron® depending on your performance and cost consideration. Its 5-slot capacity gives the same level of expandability as most IPCs. The front-accessible I/O design, including 2 GbE, 4 USB 3.0 and 5 COM ports, makes it easier to access your Nuvo-6000 when it's placed inside a cabinet or a rack.

Neosys' proven fanless design on Nuvo-6000 presents extraordinary reliability in all circumstances. And its versatile mounting options make it fit for desktop, cabinet or a 19" rack. With similar performance and cost, better form-factor and reliability, Nuvo-6000 series is speaking for itself on the new horizon of industrial computer.



Nuvo-6032



Nuvo-6002

# 1.2 Product Specification

## 1.2.1 Specification of Nuvo-6032

<b>System Core</b>	
Processor	Supports 6th-Gen Intel® Core™, Pentium® and Celeron® LGA1151 CPU - Intel® Core™ i7-6700TE (8M Cache, 2.4/3.4 GHz, 35W TDP) - Intel® Core™ i5-6500TE (6M Cache, 2.3/3.3 GHz, 35W TDP) - Intel® Core™ i3-6100TE (4M Cache, 2.7 GHz, 35W TDP) - Intel® Pentium® G4400TE (3M Cache, 2.4 GHz, 35W TDP) - Intel® Celeron® G3900TE (2M Cache, 2.3 GHz, 35W TDP)
Chipset	Intel® H110 Platform Controller Hub
Graphics	Integrated Intel® HD 530/510 Controller
Memory	Up to 16 GB DDR4-2133 by one SODIMM socket
<b>Front-panel I/O Interface</b>	
Ethernet	1x Gigabit Ethernet port by Intel I219-LM 1x Gigabit Ethernet port by Intel I210-IT
Video Port	2x DVI-D connectors for DVI/HDMI outputs, supporting 1920x1200 resolution
Serial Port	2x Software-programmable RS-232/422/485 ports 2x 3-wire RS-232 ports (via single DB9 connector)
USB	4x USB 3.0 ports
Audio	1x Speaker-out
<b>Expansion Bus</b>	
PCI Express	1x PCIe x16 slot @ Gen3, 16-lanes PCIE signals 1x PCIe x8 slot @ Gen2, 4-lanes PCIE signals
PCI	3x 33MHz/32-bit 5V PCI slots
<b>Internal I/O Interface</b>	
USB	2x USB 2.0 ports via 16-pin box-header on PCBA 1x USB 2.0 ports via Type-A connector on backplane
<b>Storage Interface</b>	
SATA HDD	3x Internal SATA ports for 2.5" HDD/SSD installation
mSATA	1x full-size mSATA socket
<b>Power Supply</b>	
DC Input	1x 3-pin pluggable terminal block for 8~35 VDC input
Power Consumption	With i7-6700TE: 48.52W@24VDC With i5-6500TE: 44.38W@24VDC With i3-6100TE: 34.83W@24VDC





<b>Mechanical</b>	
Dimension	184 mm (W) x 225 mm (D) x 174 mm (H)
Weight	3.5 kg (with one 2.5" HDD and DDR4 memory module)
Mounting	Wall-mounting (Standard) DIN-Rail mounting clip(Optional) Rack-mounting kit (Optional)
<b>Environmental</b>	
Operating Temperature	-25°C ~ 60°C, 100% CPU loading */**
Storage Temperature	-40°C ~85°C
Humidity	10%~90% , non-condensing
Vibration	Operating, 5Grms, 5-500 Hz, 3 Axes (w/ SSD, w/o add-on card, according to IEC60068-2-64)
Shock	Operating, 50Grms, Half-sine 11ms Duration (w/ SSD, w/o add-on card, according to IEC60068-2-27)
EMC	CE/FCC Class A, according to EN 55022 & EN 55024

\* The high operating temperature specified here is defined under the condition of 100% CPU loading applied using Passmark® BurnInTest 8.0. For detail testing criteria, please contact Neosys Technology

\*\* For sub-zero operating temperature, a wide temperature HDD drive or Solid State Disk (SSD) is required.



## 1.2.2 Specification of Nuvo-6002

<b>System Core</b>	
Processor	Supports 6th-Gen Intel® Core™, Pentium® and Celeron® LGA1151 CPU - Intel® Core™ i7-6700TE (8M Cache, 2.4/3.4 GHz, 35W TDP) - Intel® Core™ i5-6500TE (6M Cache, 2.3/3.3 GHz, 35W TDP) - Intel® Core™ i3-6100TE (4M Cache, 2.7 GHz, 35W TDP) - Intel® Pentium® G4400TE (3M Cache, 2.4 GHz, 35W TDP) - Intel® Celeron® G3900TE (2M Cache, 2.3 GHz, 35W TDP)
Chipset	Intel® H110 Platform Controller Hub
Graphics	Integrated Intel® HD 530/510 Controller
Memory	Up to 16 GB DDR4-2133 by one SODIMM socket
<b>Front-panel I/O Interface</b>	
Ethernet	1x Gigabit Ethernet port by Intel I219-LM 1x Gigabit Ethernet port by Intel I210-IT
Video Port	2x DVI-D connectors for DVI/HDMI outputs, supporting 1920x1200 resolution
Serial Port	2x Software-programmable RS-232/422/485 ports 2x 3-wire RS-232 ports (via single DB9 connector)
USB	4x USB 3.0 ports
Audio	1x Speaker-out
<b>Expansion Bus</b>	
PCI Express	1x PCIe x16 slot @ Gen3, 16-lanes PCIE signals 1x PCIe x8 slot @ Gen2, 4-lanes PCIE signals
<b>Internal I/O Interface</b>	
USB	2x USB 2.0 ports via 19-pin box-header on PCBA 1x USB 2.0 ports via Type-A connector on backplane
<b>Storage Interface</b>	
SATA HDD	1x Internal SATA ports for 2.5" HDD/SSD installation
mSATA	1x full-size mSATA socket
<b>Power Supply</b>	
DC Input	1x 3-pin pluggable terminal block for 8~35 VDC input
Power Consumption	With i7-6700TE: 48.52W@24VDC With i5-6500TE: 44.38W@24VDC With i3-6100TE: 34.83W@24VDC
<b>Mechanical</b>	
Dimension	124 mm (W) x 225 mm (D) x 174 mm (H)
Weight	2.8 kg (with one 2.5" HDD and DDR4 memory module)



Mounting	Wall-mounting (Standard) DIN-Rail mounting clip(Optional) Rack-mounting kit (Optional)
<b>Environmental</b>	
Operating Temperature	-25°C ~ 60°C, 100% CPU loading */**
Storage Temperature	-40°C ~85°C
Humidity	10%~90% , non-condensing
Vibration	Operating, 5Grms, 5-500 Hz, 3 Axes (w/ SSD, w/o add-on card, according to IEC60068-2-64)
Shock	Operating, 50Grms, Half-sine 11ms Duration (w/ SSD, w/o add-on card, according to IEC60068-2-27)
EMC	CE/FCC Class A, according to EN 55022 & EN 55024

\* The high operating temperature specified here is defined under the condition of 100% CPU loading applied using Passmark® BurnInTest 8.0. For detail testing criteria, please contact Neosys Technology

\*\* For sub-zero operating temperature, a wide temperature HDD drive or Solid State Disk (SSD) is required.



# Chapter 2 Getting to know your Nuvo-6000

## 2.1 Unpacking your Nuvo-6000

When you receive the package of Nuvo-6000 series, please check immediately if the package contains all the items listed in the following table. If any item is missing or damaged, please contact your local dealer or Neosys Technology Inc. for further assistance.

### For Nuvo-6032

Item	Description	Qty
1	Nuvo-6032 fanless BoxPC (According to the configuration you order, the Nuvo-6032 may contain CPU, HDD and DDR4. Please verify these items if necessary.)	1
2	Accessory box, which contains <ul style="list-style-type: none"> <li>● SATA HDD tray (for dual HDD installation)</li> <li>● SATA HDD bracket (for single HDD installation)</li> <li>● Wall-mounting bracket</li> <li>● Neosys Drivers &amp; Utilities DVD</li> <li>● Screw package</li> </ul>	1 1 2 1 1

### For Nuvo-6002

Item	Description	Qty
1	Nuvo-6002 fanless BoxPC (According to the configuration you order, the Nuvo-6002 may contain CPU, HDD and DDR4. Please verify these items if necessary.)	1
2	Accessory box, which contains <ul style="list-style-type: none"> <li>● SATA HDD bracket (for single HDD installation)</li> <li>● Wall-mounting bracket</li> <li>● Neosys Drivers &amp; Utilities DVD</li> <li>● Screw package</li> </ul>	1 2 1 1



## 2.2 Front Panel I/O Functions

On Nuvo-6000, we design all general-purpose I/O functions on the front panel so you can easily access them. In this section, we'll illustrate each I/O function on the front panel.

### 2.2.1 Power Button



The power button is a non-latched switch for ATX mode on/off operation. To turn on the Nuvo-6000, press the power button and the PWR LED is lighted up. To turn off the Nuvo-6000, you can either issue a shutdown command in OS, or just simply press the power button. In case of system halts, you can press and hold the power button for 5 seconds to compulsorily shut down the system. Please note that a 5 seconds interval is kept by the system between two on/off operations (i.e. once turning off the system, you shall wait for 5 seconds to initiate another power-on operation).

### 2.2.2 Reset Button



The reset button is used to manually reset the system in case of any abnormal condition. To avoid unexpected operation, the reset button is hidden behind the front panel. You need to use a pin-like object to push the reset button.

## 2.2.3 Speaker-Out Jack



Nuvo-6000 provides audio function using Intel® High Definition Audio (built-in in H110 PCH) and Realtek ALC262 codec. There is an audio jack available on the front panel for speaker output. To utilize the audio function in Windows, you need to install corresponding drivers for both Intel® H110 PCH and Realtek ALC262 codec. Please refer to section 4.3 for information regarding driver installation.

## 2.2.4 LED Indicators



There are four LED indicators on the front panel: PWR, UID, WDT and HDD. The descriptions of these three LED are listed in the following table.

Indicator	Color	Description
PWR	Green	Power indicator, lighted-up when system is on.
UID	Green	Reserved for future usage.
WDT	Yellow	Watchdog timer indicator, flashing when watchdog timer is started.
HDD	Red	Hard drive indicator, flashing when SATA HDD is active.



## 2.2.5 USB 3.0 Connectors



Nuvo-6000 series offers four USB 3.0 (SuperSpeed USB) ports on its front panel. They are implemented by native xHCI (eXtensible Host Controller Interface) controller in H110 chipset and are compatible with USB 3.0, USB 2.0, USB 1.1 and USB 1.0 devices. Legacy USB support is also provided so you can use USB keyboard/mouse in DOS environment. Due to the nature that XHCI driver is not included natively in Windows 7, you may encounter the issue of USB keyboard/mouse not working when installing Windows 7. Neosys offers a Windows-based batch file and step-by-step guide to help you. Please refer to Appendix A for information of installing Windows 7 on Nuvo-6000 series.

## 2.2.6 Gigabit Ethernet Port

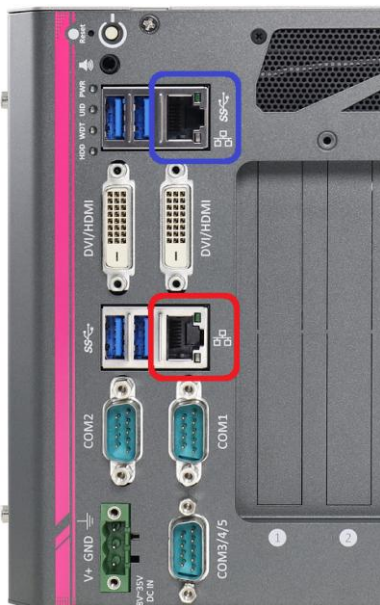

Nuvo-6000 series offers 2 GbE ports on its front panel. The GbE port marked in blue is implemented with Intel® I219-LM and port marked in red is implemented with Intel® I210-IT Gigabit Ethernet controllers. Each port has one dedicated PCI Express link to present maximal network performance. When plugging in the Ethernet cable, you can tell the Ethernet status and speed from the LED indicators on the RJ45 connector as following:

### Active/Link LED

LED Color	Status	Description
Green	Off	Ethernet port is disconnected
	On	Ethernet port is connected and no data transmission
	Flashing	Ethernet port is connected and data is transmitting/receiving

## Speed LED

LED Color	Status	Description
Green or Orange	Off	10 Mbps
	Green	100 Mbps
	Orange	1000 Mbps

The port implemented using Intel® I219-LM supports Wake-on-LAN function. To utilize the GbE port in Windows, you need to install corresponding driver for Intel® I210-IT/I219-LM GbE controller. Please refer to section 4.3 for information of driver installation.

## 2.2.7 DVI-D Connector

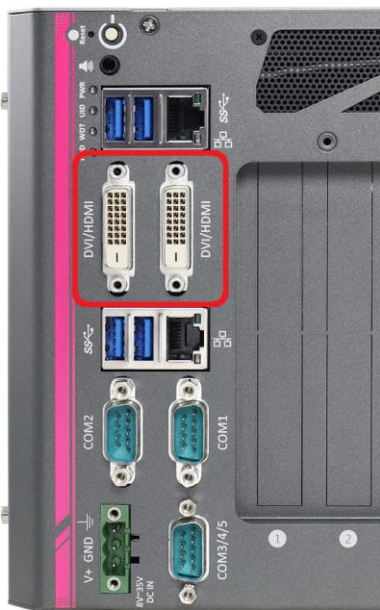

Nuvo-6000 series has two DVI-D connectors on its front panel to support dual independent display outputs. DVI/HDMI transmits graphics data in digital format and therefore can deliver better image quality at high resolution. The DVI/HDMI connectors can either output DVI signals or HDMI signals depending on the display device connected. It supports up to 1920 x 1200 resolution. You can use a DVI to HDMI cable to connect a HDMI display device.



For users who need VGA output, Neousys also offers a DVI-to-VGA adapter as an optional accessory, so you can use Nuvo-6000 with a VGA monitor.



The feature of dual independent display outputs is only available in Windows 7/8/10 with corresponding graphics driver installed. Please refer to section 4.3 for information regarding driver installation.



## 2.2.8 COM Ports (COM1/COM2)

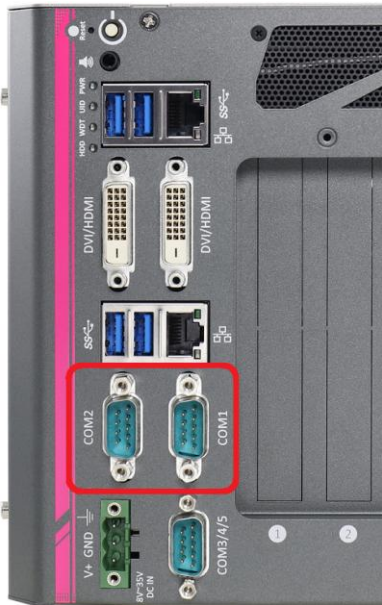

Nuvo-6000 provides totally five COM ports for communicating with external devices. These COM ports are implemented using industrial-grade ITE8786 Super IO chip (-40 to 85°C) and provide up to 115200 bps baud rate.

COM1 and COM2 are software-selectable RS-232/422/485 ports. The operation mode of COM1 and COM2 can be set in BIOS setup utility (refer to section 4.1.1 for detail). The following table describes the pin definition of COM ports.

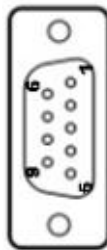

	COM1 & COM2		
Pin#	RS-232 Mode	RS-422 Mode	RS-485 Mode (Two-wire 485)
1	DCD		
2	RX	422 TXD+	485 TXD+/RXD+
3	TX	422 RXD+	
4	DTR	422 RXD-	
5	GND	GND	GND
6	DSR		
7	RTS		
8	CTS	422 TXD-	485 TXD-/RXD-
9	GND		

## 2.2.9 COM Ports (COM3/COM4/COM5)



Nuvo-6000 provides totally five COM ports for communicating with external devices. These COM ports are implemented using industrial-grade ITE8786 Super IO chip (-40 to 85°C) and provide up to 115200 bps baud rate.

COM3, COM4 and COM5 are 3-wire RS-232 ports share single DB9 connector. You can directly connect this to one external device with 3-wire RS-232 interface, or use an optional 1-to-3 Y-cable to have three DB9 connectors for more devices. The following table describes the pin definition of the DB9 connector as well as the Y-cable.

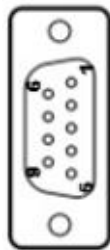

	COM3/4/5 DB9		
Pin#	COM3	COM4	COM5
1			
2	RX		
3	TX		
4		TX	
5	GND	GND	GND
6		RX	
7			TX
8			RX
9			

	Y-Cable DB9
Pin#	COM3 (A) COM4 (B) COM5 (C)
1	
2	RX
3	TX
4	
5	GND
6	
7	
8	
9	

## 2.2.10 3-Pin Terminal Block for DC Input

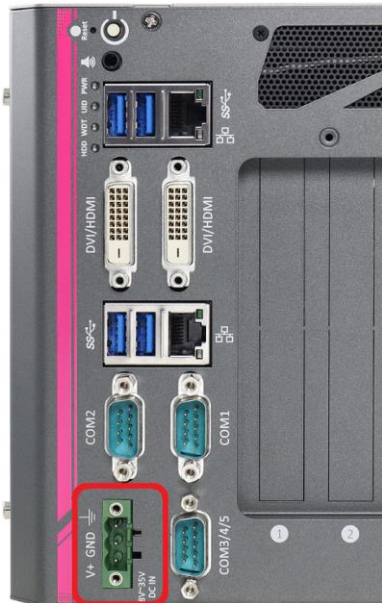

Nuvo-6000 series allows a wide range of DC power input from 8 to 35V via a 3-pin pluggable terminal block, which is fit for field usage where DC power is usually provided. And the screw clamping connection of the terminal block gives a very reliable way of wiring DC power. For detail information of supplying DC power via pluggable terminal block, please refer to section 3.9.

Symbol	Description
	Chassis ground (connect to the earth ground)
GND	Negative polarity (ground) of DC input
V+	Positive polarity of DC input

### Caution

1. Please make sure the voltage of DC power is correct before you connect it to Nuvo-6000 controller. Supplying a voltage over 35V will damage the system.

## 2.3 Internal I/O Functions

In addition to I/O connectors on the front panel, Nuvo-6000 provides more useful features via its on-board connectors, such as remote on/off control, LED status output, internal USB 2.0 ports, 12V power and etc. In this section, we'll illustrate these internal I/O functions.

### 2.3.1 Status LED Output & Remote On/Off Control

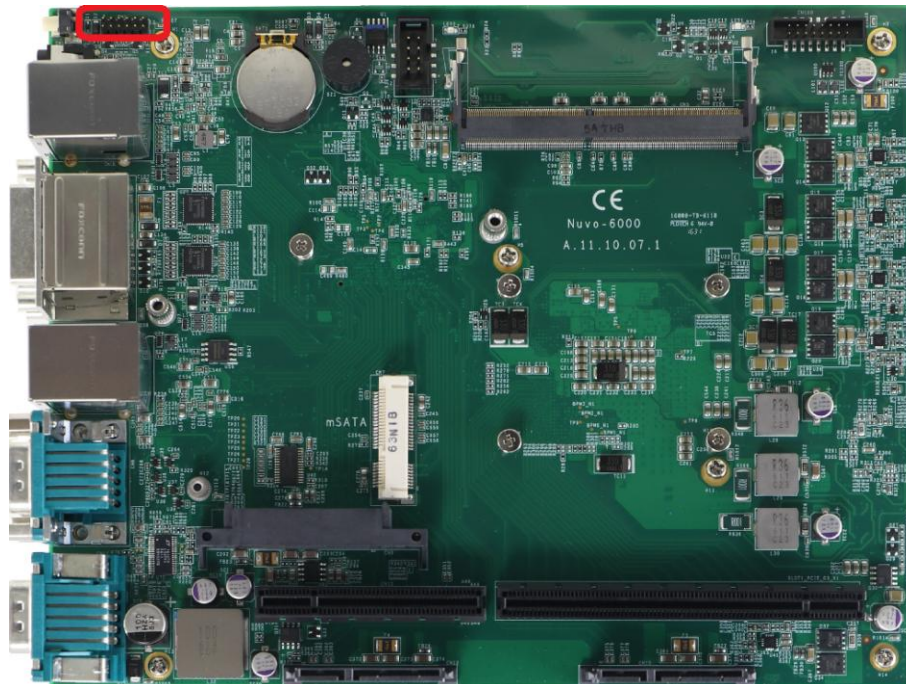

For an application which places Nuvo-6000 inside a cabinet, it's useful to output the system status to external LED indicators so that users can check how the system's running. Nuvo-6000 provides a 2x6, 2.0mm pitch pin header to output system status such as power, HDD, watchdog timer, and control system on/off remotely.

The status LED output has a built-in series-resistor and provides 10mA current to directly drive the external LED indicators. System on/off control is also provided so you can use an external non-latched switch to turn on/off the system exactly the same as the power button on the front panel. The following table describes the pin definition of the status LED output.

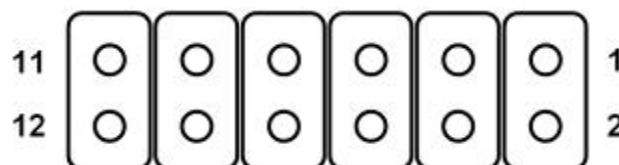

Pin#	Definition	Description
1	WDT_LED-	<b>[Output]</b> Watchdog timer indicator, flashing when watchdog timer is started.
2	WDT_LED+	
3	UID_LED-	<b>[Output]</b> User defined LED, reserved for future usage
4	UID_LED+	
5	HDD-	<b>[Output]</b> Hard drive indicator, flashing when SATA hard drive is active.
6	HDD+	
7	Power_LED-	<b>[Output]</b> System power indicator, on if system is turned on, off if system is turned off.
8	Power_LED+	
9	Ctrl-	<b>[Input]</b> Remote on/off control, connecting to an external switch to turn on/off the system. (polarity is negligible).
10	Ctrl+	
11	NA	Un-used pin
12	NA	

**Note**

*Please make sure the polarity is correct when you connect the external LED indicator to the Status LED Output.*



## 2.3.2 DDR4 SODIMM Socket

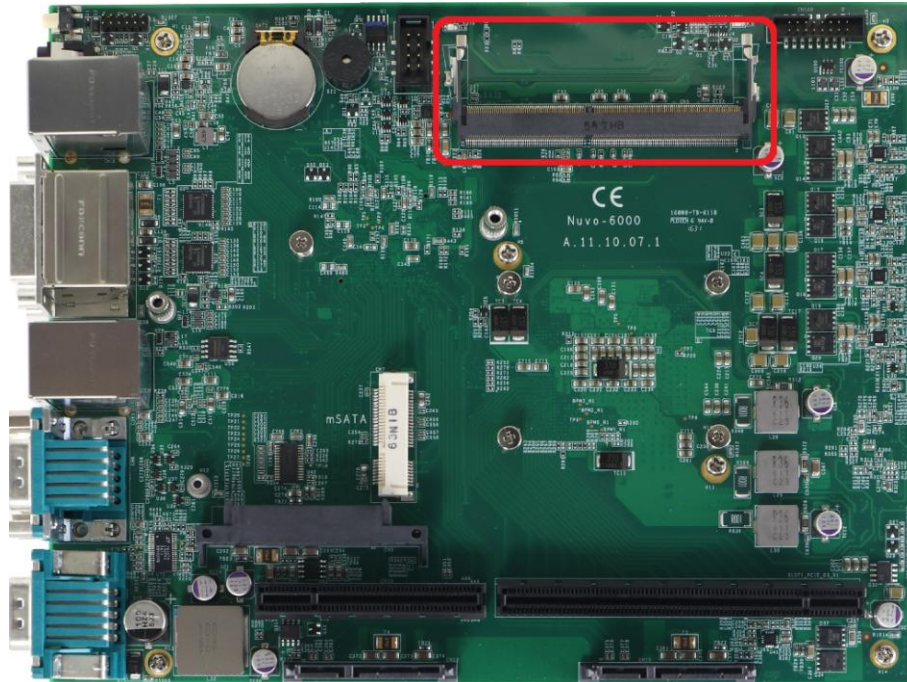

Nuvo-6000 series provides one 260-pin, SODIMM socket for installing DDR4 memory module. It supports maximal 16GB capacity by installing one 16GB DDR4 2133 MHz SODIMM modules. For information of installing DDR4 memory modules, please refer to section 3.3 for details.

## 2.3.3 Internal USB 2.0 Box Header

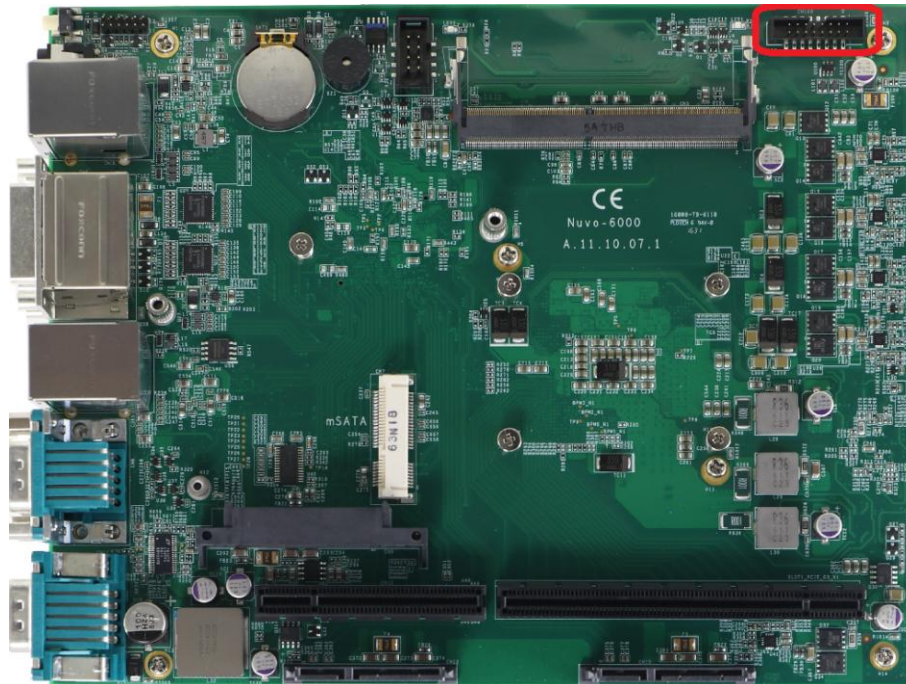

Nuvo-6000 provides additional two USB 2.0 ports internally via a 2x8 pins, 2.0mm pitch box header. The internal USB ports are designed to allow users attaching additional USB devices inside the chassis. To use the internal USB port, you shall need a dedicated box-header to USB cable. Please contact Neosys for further information.

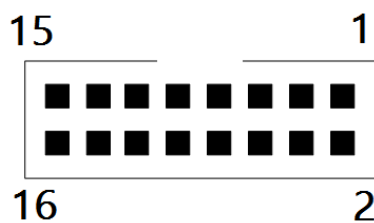

Pin#	Pin Definition
1	USB 5V Power, Max 500mA
2	USB 5V Power, Max 500mA
3	USB6 D-
4	USB7 D-
5	USB6 D+
6	USB7 D+
7	Ground
8	Ground
9 ~ 16	N/C

## 2.3.4 mSATA Socket

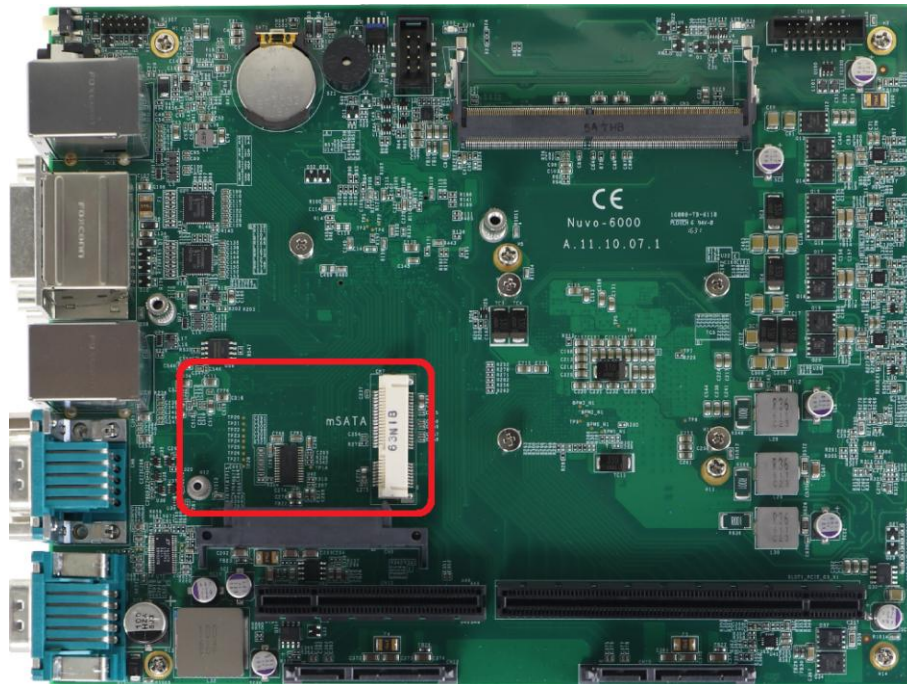

Nuvo-6000 provides a mSATA port to accommodate mSATA flash disk module. mSATA is a solid-state storage device with SATA interface and is very reliable for harsh environments with intense vibration/shock. The system recognizes mSATA as a native storage device and accordingly you can install any operating system in the mSATA module, such as Windows 7, Windows 8, Windows 10, Linux and etc.



## 2.3.5 SATA #1 Port

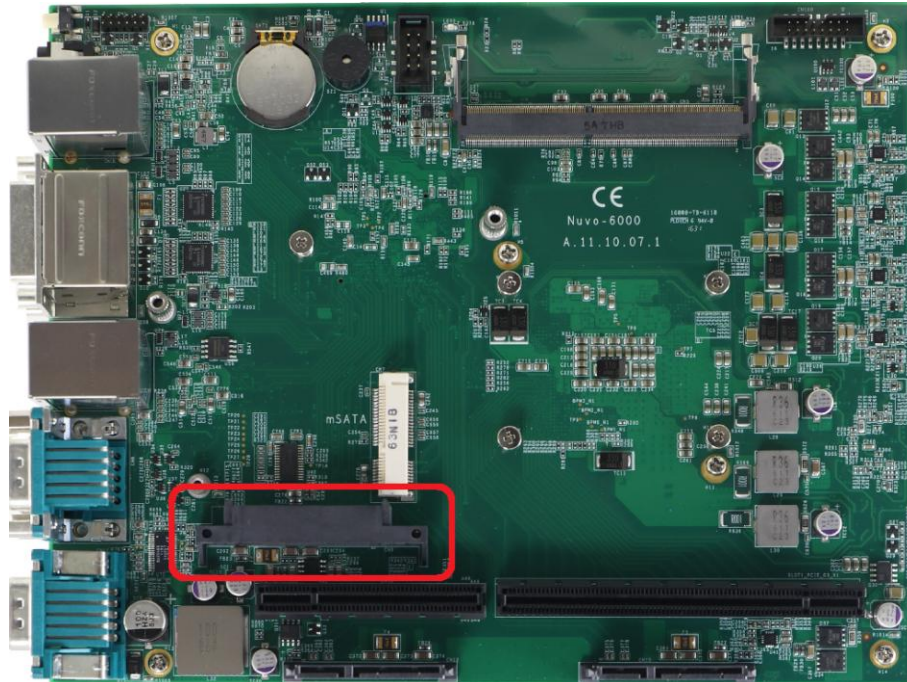

Nuvo-6000 provides totally three SATA ports. Nuvo-6032 can accommodate three 2.5" SATA hard drives and Nuvo-6002 can only accommodate one due the restriction of chassis space.

SATA port #1 is located on the SBC via a 22-pin SATA connector. You can directly mount a 2.5" HDD/SSD to this port using the HDD bracket shipped with Nuvo-6000. For information of installing HDD/SSD to the SATA port #1, please refer to section 3.5.1 for detail.

## 2.3.6 SATA #2 and SATA #3 Ports (Nuvo-6032 Only)

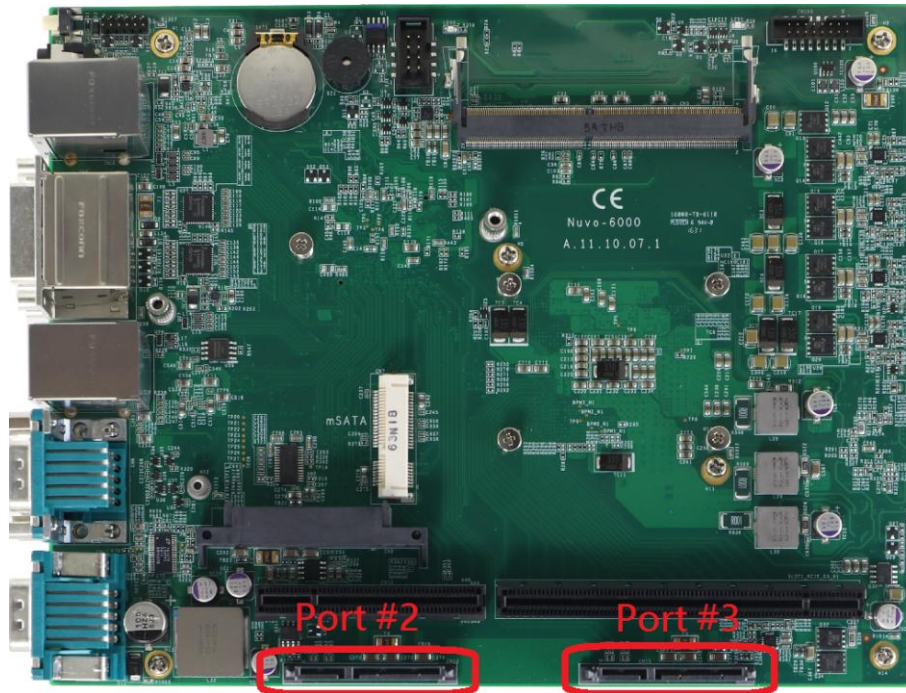

Nuvo-6000 provides totally three SATA ports. Nuvo-6032 can accommodate three 2.5" SATA hard drives and Nuvo-6002 can only accommodate one due the restriction of chassis size.

SATA port #2 and port #3 are located on the SBC via two 22-pin SATA connectors. You shall use the HDD tray shipped with Nuvo-6032 for the installation of 2.5" HDD/SSD. For information of installing HDD/SSD to the SATA port #2 and port #3, please refer to section 3.5.2 for detail.

## 2.3.7 12 VDC PCIe Power Connector

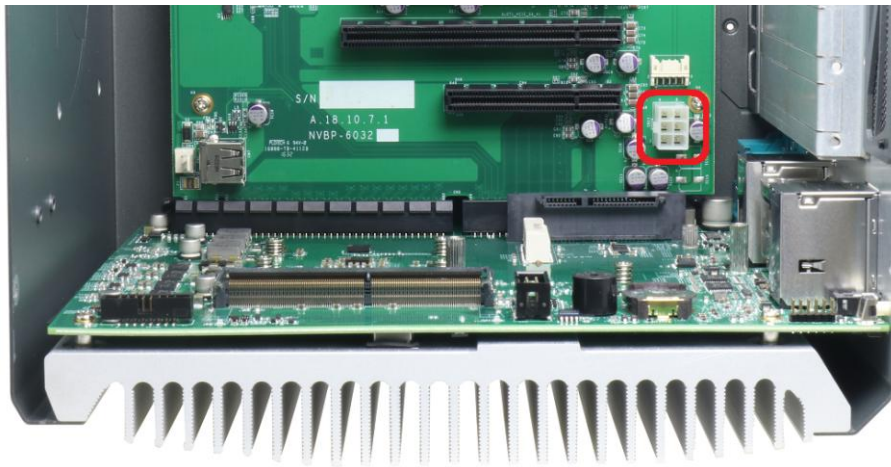

Some high-watt add-on cards require additional 12V input. Nuvo-6000 offers a 6-pin PCIe power connector on its backplane to provide up to 8A rated current. This can be useful if you want to power a PCI Express graphics card with up to 90W TDP.

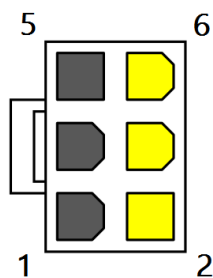

Pin#	Pin Definition
1	GND
2	12 VDC
3	GND
4	12 VDC
5	GND
6	12 VDC

## 2.3.8 Internal USB Port



In addition to the USB header connector on the SBC, Nuvo-6000 offers another USB 2.0 Type-A port on the backplane. You can utilize this USB port to connect a USB protection dongle inside the chassis of Nuvo-6000 controller.



## 2.3.9 PCI Express Slots



Both Nuvo-6032 and Nuvo-6002 provide one x8 and one x16 PCI Express slot. The x8 slot is running at Gen2, 4-lanes PCIe signals and can deliver up to 2 GB/s bandwidth. The x16 slot is running at Gen3, 16-lanes PCIe signals and is suitable for both graphics card and I/O card installation.

The maximum allowable length of a add-on card to be installed into Nuvo-6000 is varied depending on whether the optional fan is installed. Please refer the following table to understand the restriction of dimension for add-on cards. For information of installing PCIe cards, please refer to section 3.6 for detail.

	Maximum Allowable Dimension (L x H)
Without optional fan installed	205 mm x 140 mm
With optional fan installed	185 mm x 140 mm

### Note

1. Due to the fanless feature, the total power consumption of installed PCI and PCIe cards should be confined to **16W** to limit the heat generated by add-on cards and maintain the system stability. For applications need add-on cards which consume more than 16W, the fan option is suggested to maintain a reasonable temperature inside the chassis. Please contact Neosys Technology for the fan option.
2. The operating temperature of the whole system when cards installed is affected by the power consumption and operating temperature of add-on cards. Please consult your add-on card dealer or Neosys Technology for further information.

## 2.3.10 PCI Slots (Nuvo-6032 Only)

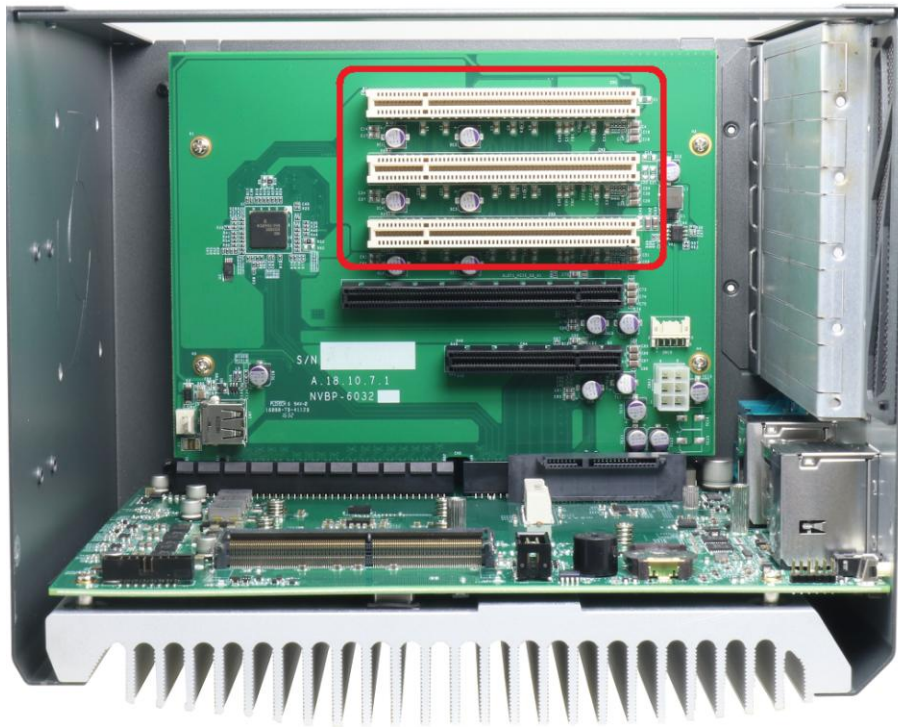

Nuvo-6032 provides three PCI slots, which support 5V, 32-bit/33MHz PCI bus, to accommodate PCI add-on cards. The maximum allowable length of a add-on card to be installed into Nuvo-6000 is varied depending on whether the optional fan is installed. Please refer the following table to understand the restriction of dimension for add-on cards. For information of installing PCI cards, please refer to section 3.6 for detail.

	Maximum Allowable Dimension (L x H)
Without optional fan installed	205 mm x 140 mm
With optional fan installed	185 mm x 140 mm

### Note

1. Due to the fanless feature, the total power consumption of installed PCI and PCIe cards should be confined to **16W** to limit the heat generated by add-on cards and maintain the system stability. For applications need add-on cards which consume more than 16W, the fan option is suggested to maintain a reasonable temperature inside the chassis. Please contact Neosys Technology for the fan option.
2. The operating temperature of the whole system when cards installed is affected by the power consumption and operating temperature of add-on cards. Please consult your add-on card dealer or Neosys Technology for further information.

## 2.4 Mechanical Dimension

### 2.4.1 Front View of Nuvo-6032

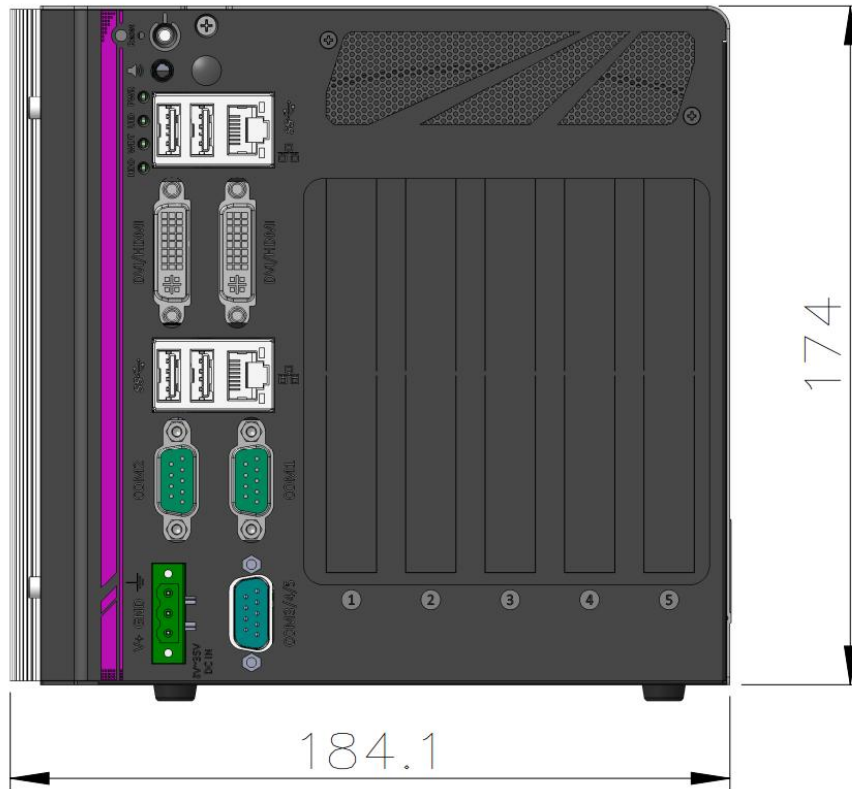

## 2.4.2 Back View of Nuvo-6032

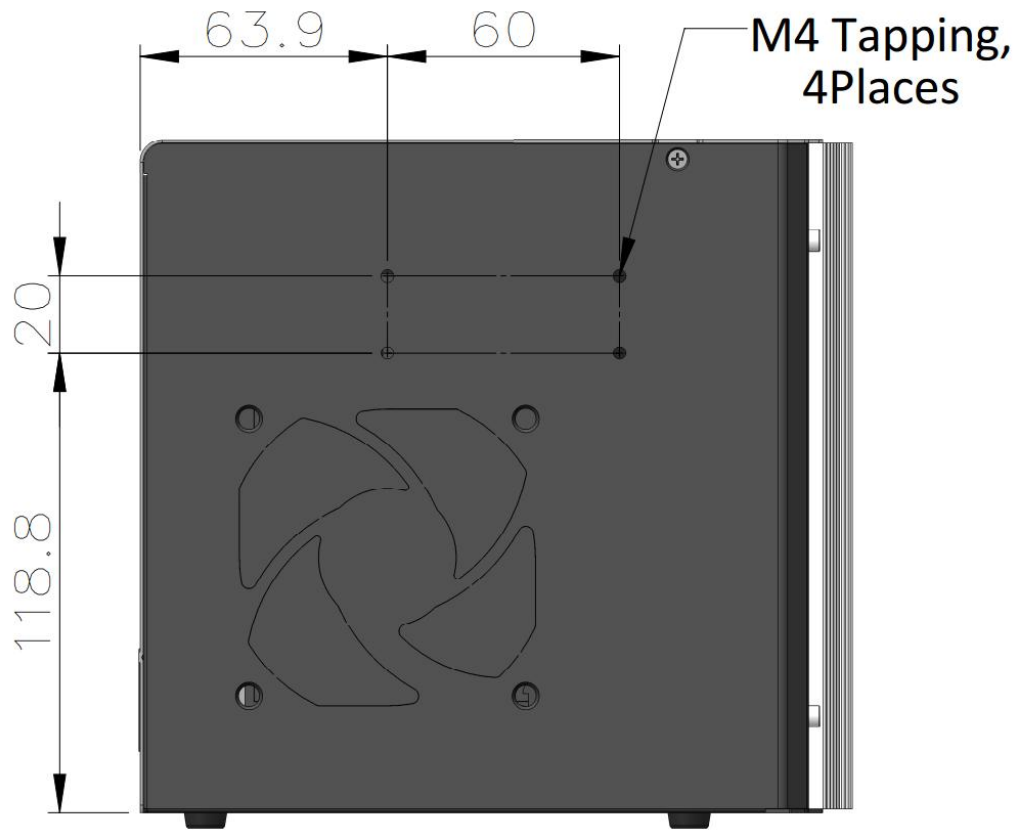



## 2.4.3 Top View of Nuvo-6032

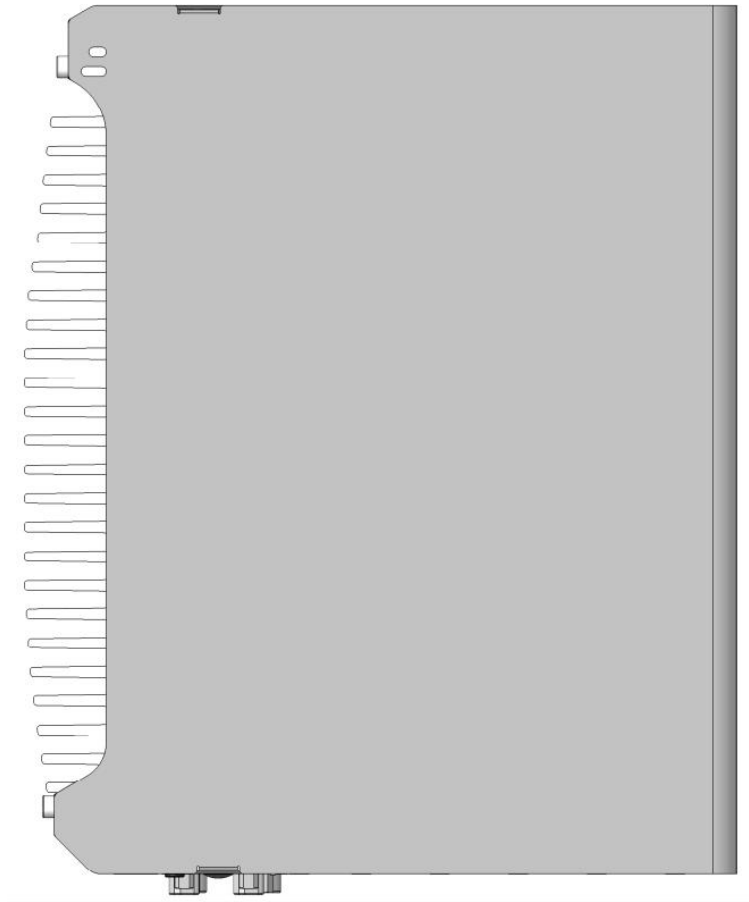

## 2.4.4 Bottom View of Nuvo-6032

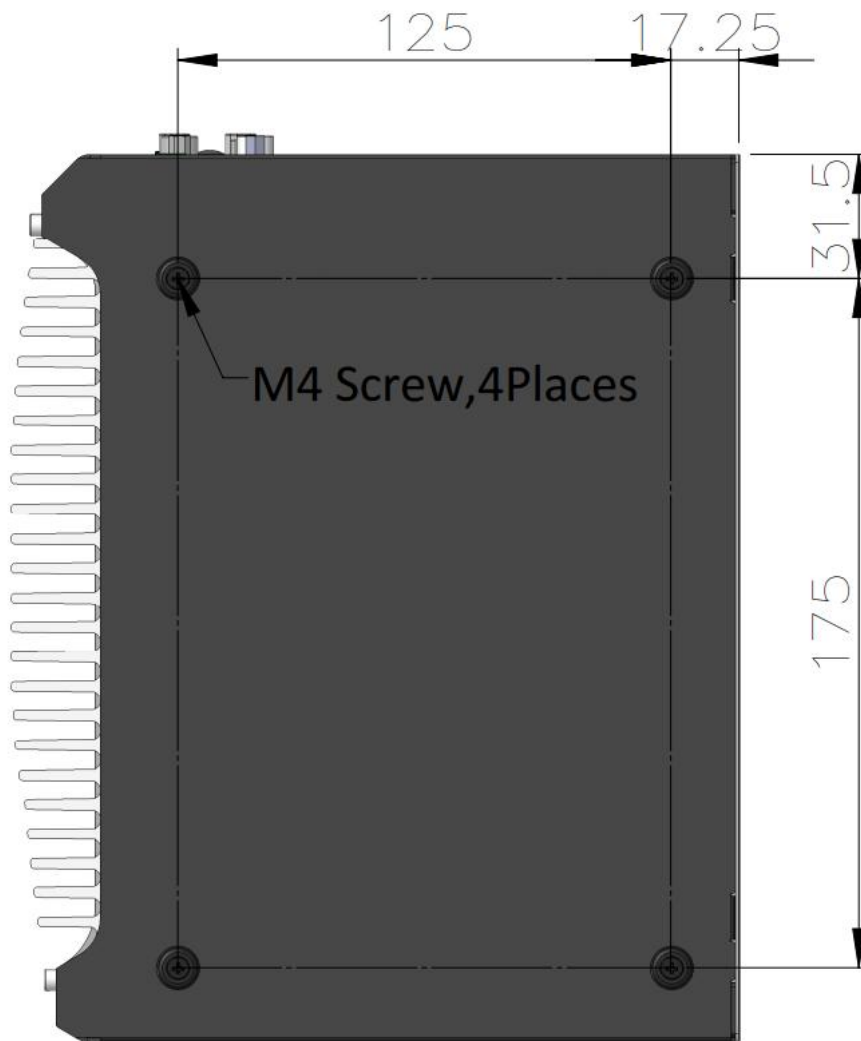

## 2.4.5 Right View of Nuvo-6032

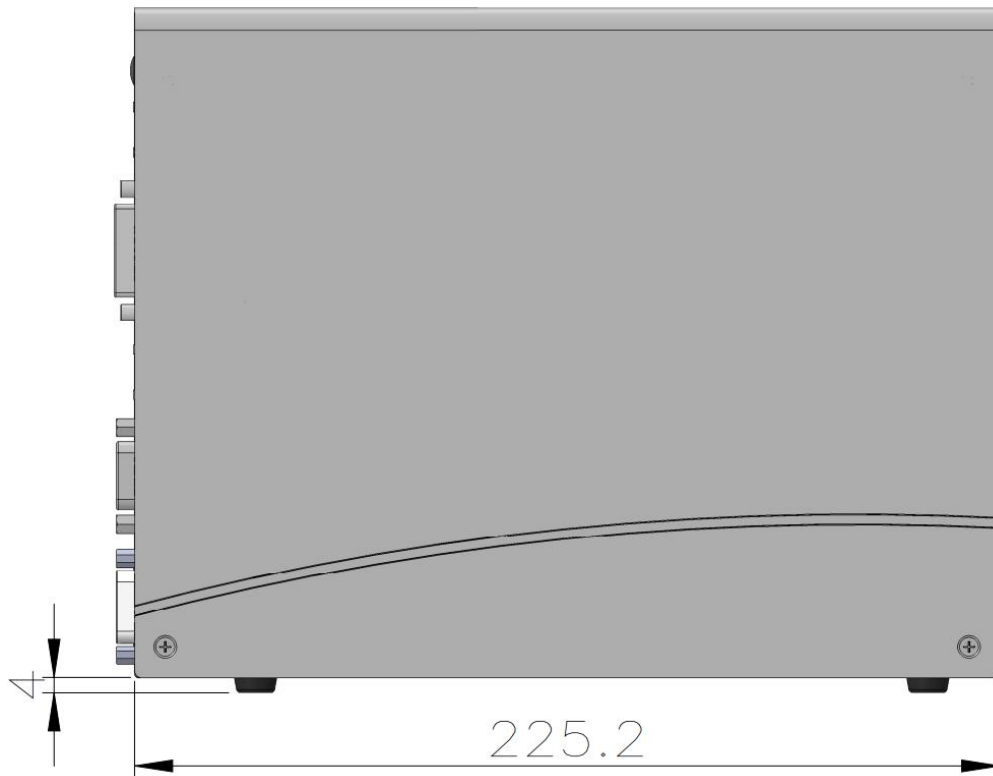

## 2.4.6 Left View of Nuvo-6032

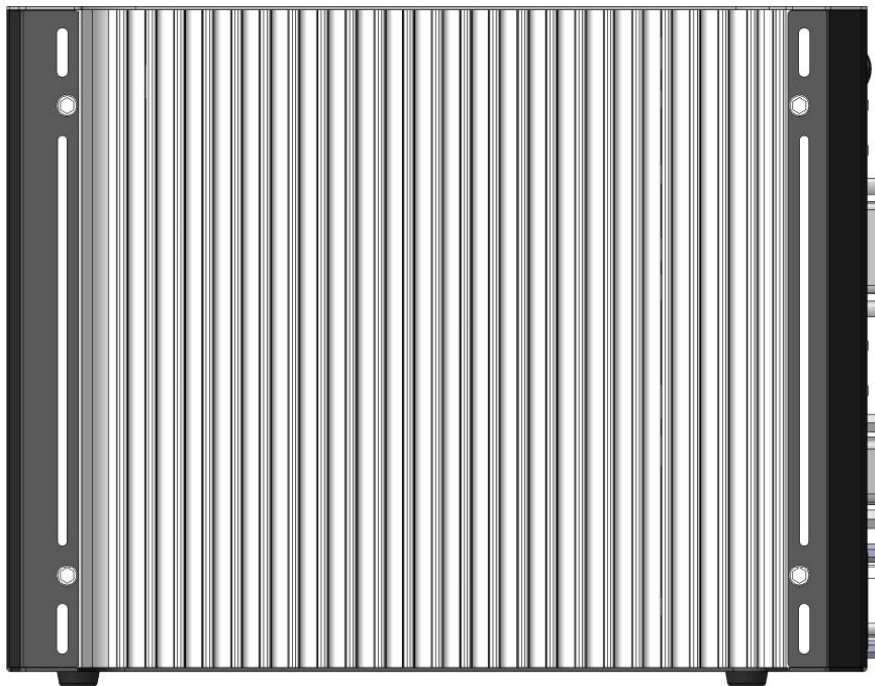

## 2.4.7 Front View of Nuvo-6002

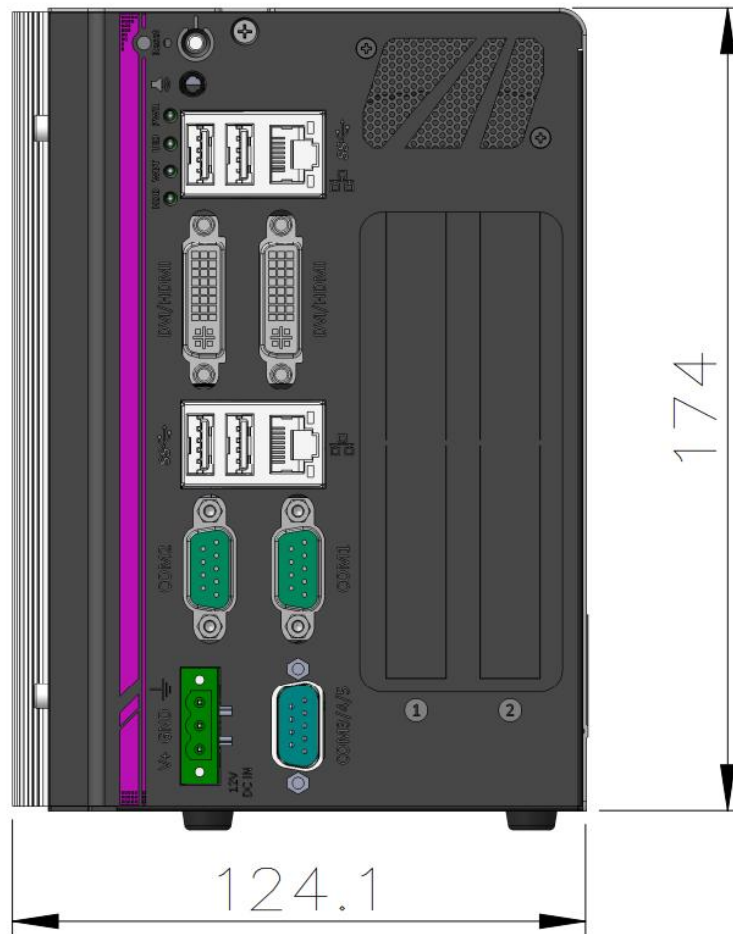

## 2.4.8 Back View of Nuvo-6002

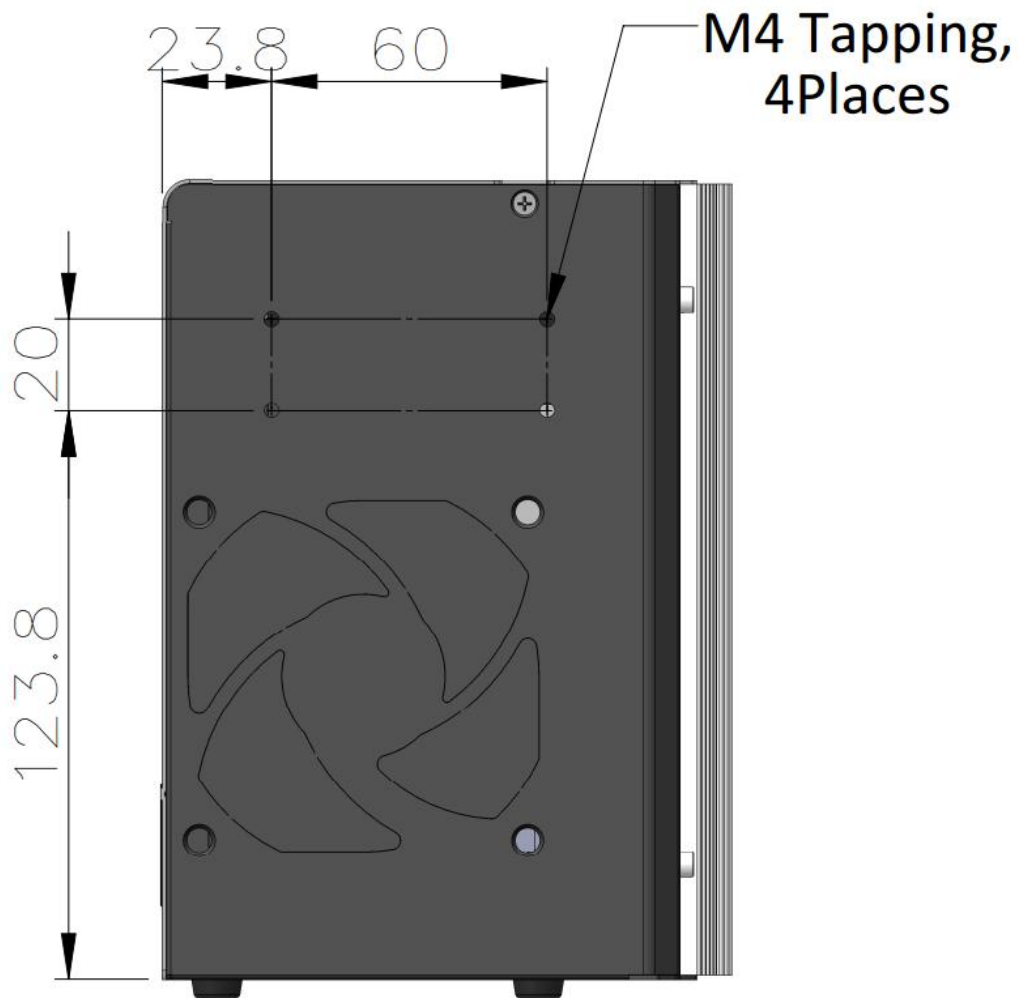

## 2.4.9 Top View of Nuvo-6002

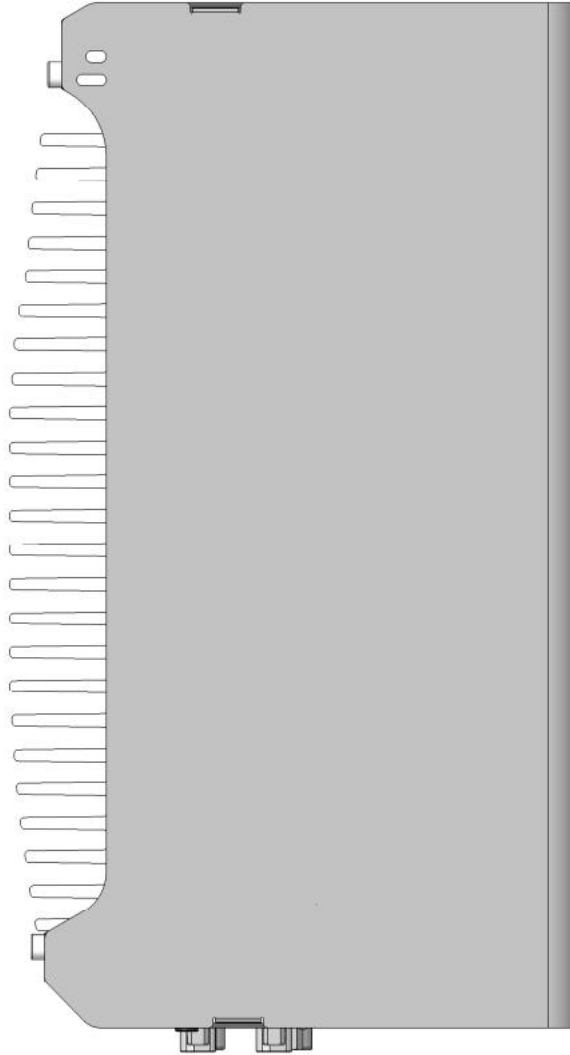

## 2.4.10 Bottom View of Nuvo-6002

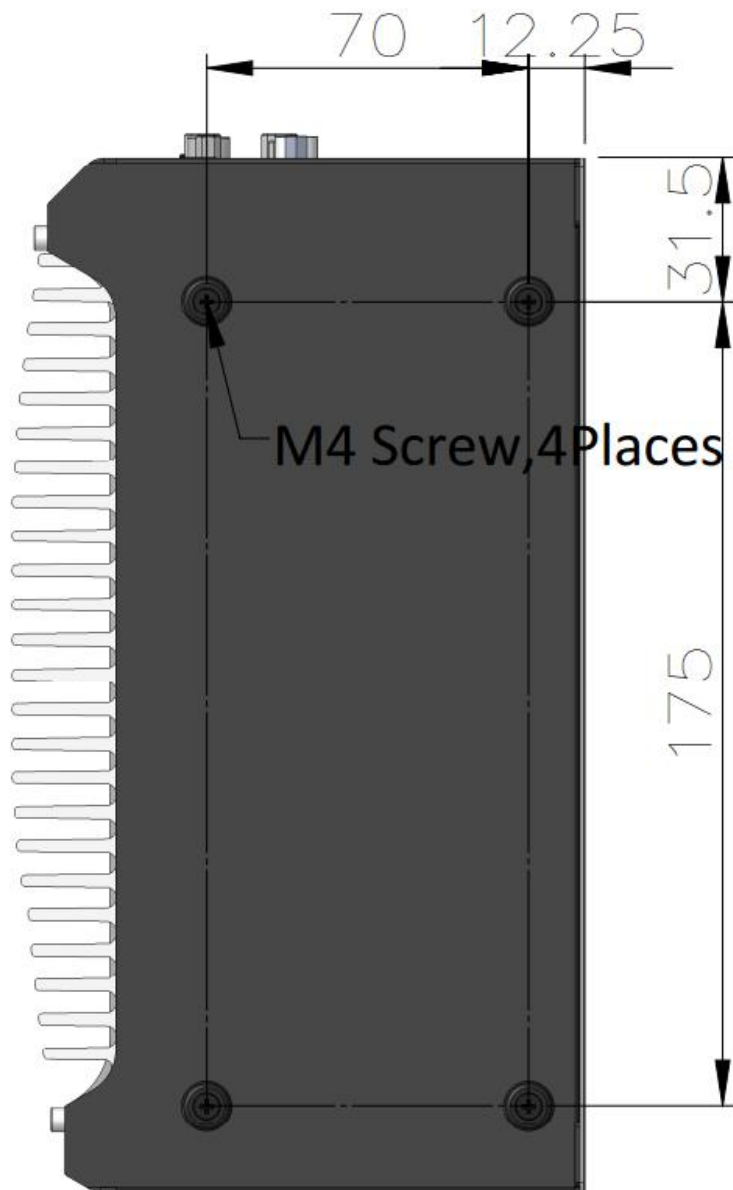

### 2.4.11 Right View of Nuvo-6002

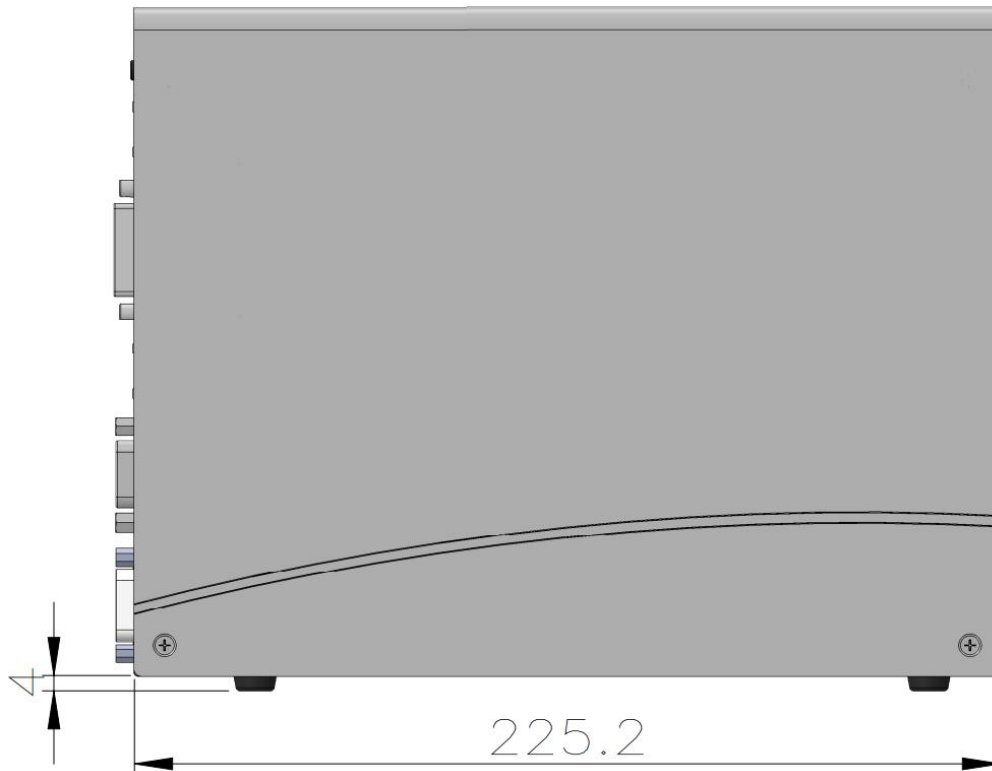

### 2.4.12 Left View of Nuvo-6002

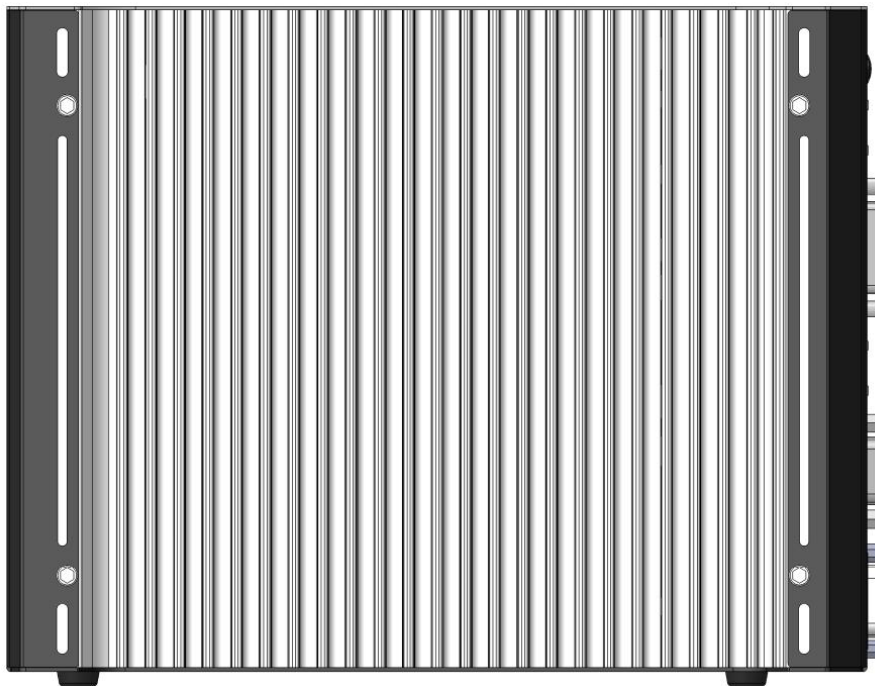



# Chapter 3 Getting Start

## 3.1 Disassemble your Nuvo-6000 Controller

In prior to install components such as CPU, memory and HDD to Nuvo-6000 series, you need to disassemble Nuvo-6000 controller and access the PCBA. Please cautiously follow the procedures described here to prevent any damage on your Nuvo-6000 controller.

### 3.1.1 Remove the Chassis Cover

1. Loose four M3, F-head screws on the front, back and right side of the chassis.

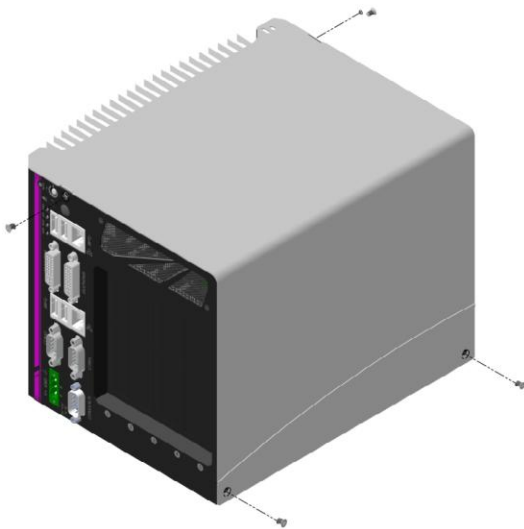

2. Gently push the L-shape chassis cover toward top, then move it toward right to remove the cover.

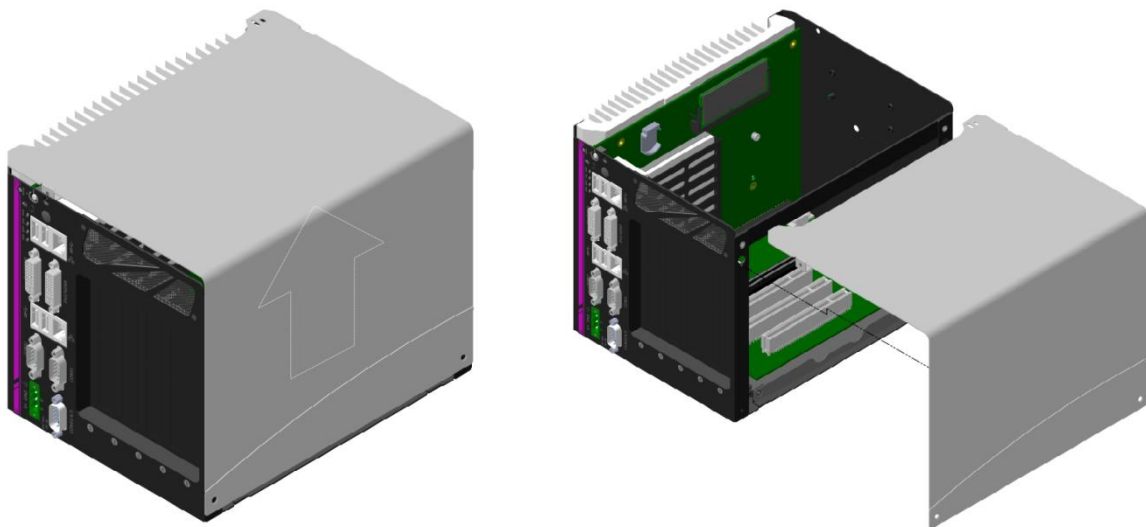

### 3.1.2 Disassemble the SBC of Nuvo-6000

1. Follow steps described in section 3.1.1 to remove chassis cover. You can see the SBC and backplane exposed.
2. Loose four M3, P-head screws on the backplane and pull it toward the direction of arrow to remove the backplane.

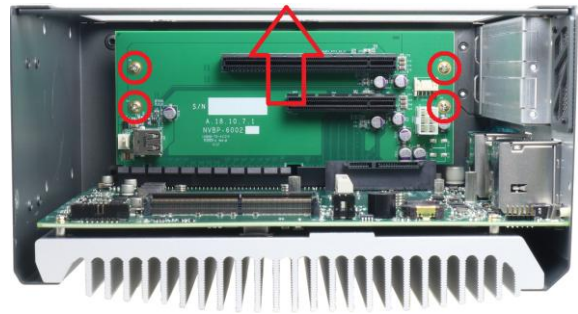
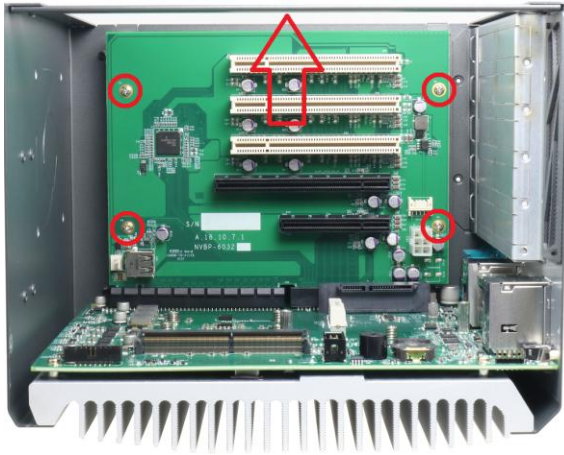

3. Remove two hex screws near COM3/4/5 connector.



- Remove four hex bolts used to fix heat-sink and chassis.



- Pull the heat-sink/SBC assembly slightly backward and lift it up to separate it from the chassis. Now you can separate the heat-sink/SBC assembly from the chassis.



## 3.2 Install and Replace a LGA1151 CPU

Nuvo-6000 series supports 6<sup>th</sup>-Gen, LGA1151 socket-type CPU. You can select the CPU according to your consideration of performance, cost and ambient condition. This section describes how to install or replace the CPU on your Nuvo-6000 controller.

### Caution

*Please carefully handle the exposed LGA socket on PCBA. The contacts of LGA1151 socket without protective cover are extremely easy to be damaged by foreign objects. You shall always put the protective cover back to the LGA socket when CPU is absent.*

### 3.2.1 Install a CPU on Nuvo-6000

1. Follow instructions described in section 3.1.2 to disassemble the heat-sink/SBC assembly from Nuvo-6000 chassis.
2. Place the heat-sink/SBC assembly on a flat surface. Remove the SBC from the heat-sink by loosening four M3 P-head.

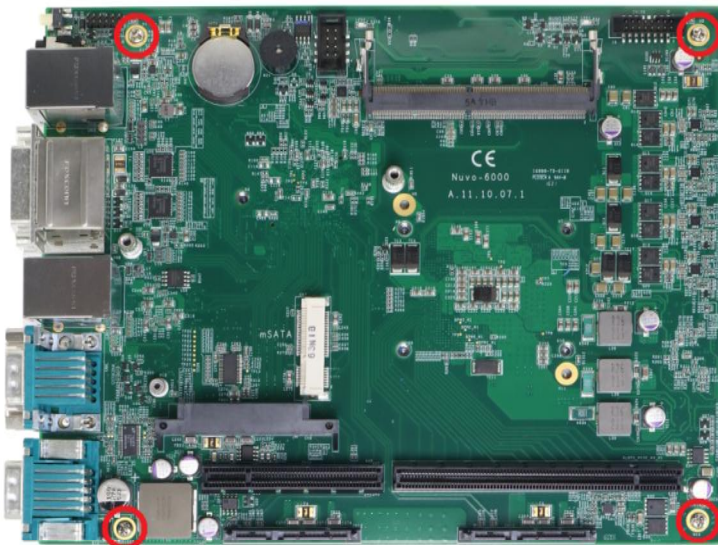



3. Gently lift the PCBA and separate it from the heat-sink.

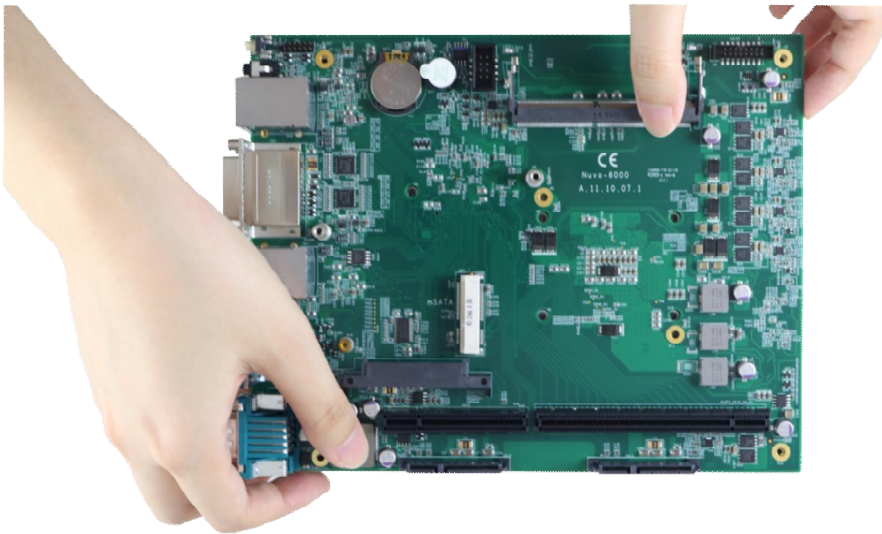

4. Place the PCBA on a flat surface. Remove the plastic protective cover from the LGA1151 socket.



**Caution**

*When the protective cover is removed and LGA1151 socket is exposed, please carefully handle the PCBA to avoid any damage on LGA socket.*

5. Make sure that you line up the two guiding notches on the LGA1151 socket with the notches along the edges of the CPU. Place the CPU into the socket and by holding it firmly by the sides and lowering it into the socket.

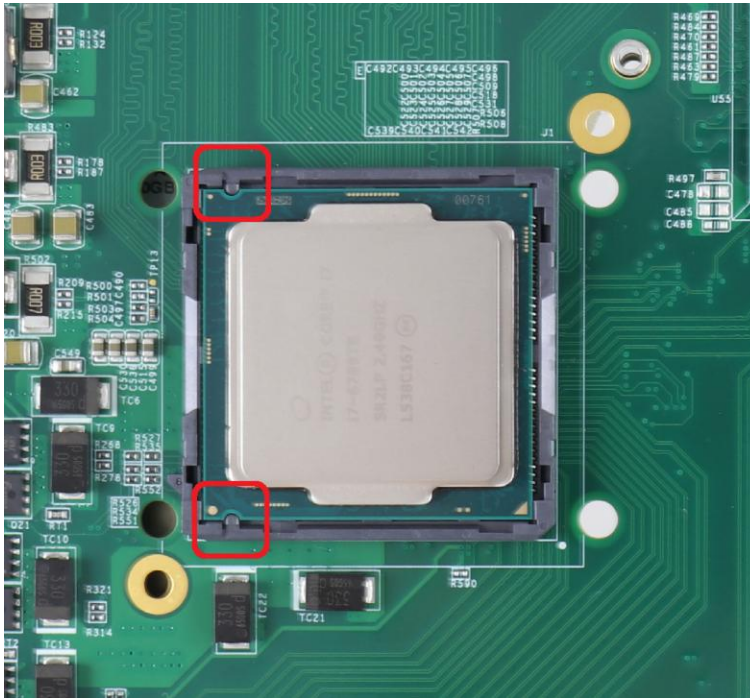

6. Get the CPU retaining bracket from the accessory box and place it on the top of CPU. The CPU retaining bracket must be screwed from the opposite side. Please hold the CPU and bracket firmly while turning the PCBA upside down, and secure the CPU retaining bracket with two M3 P-head screws.

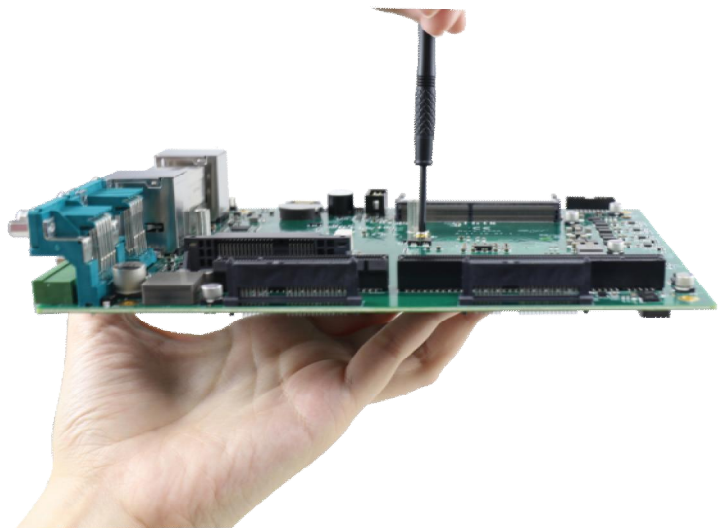

- Remove all protective films of thermal pads of the heat-sink.



- Place the PCBA back to heat-sink. Make sure all the screw holes on PCBA are aligned with mounting posts of the heat-sink.

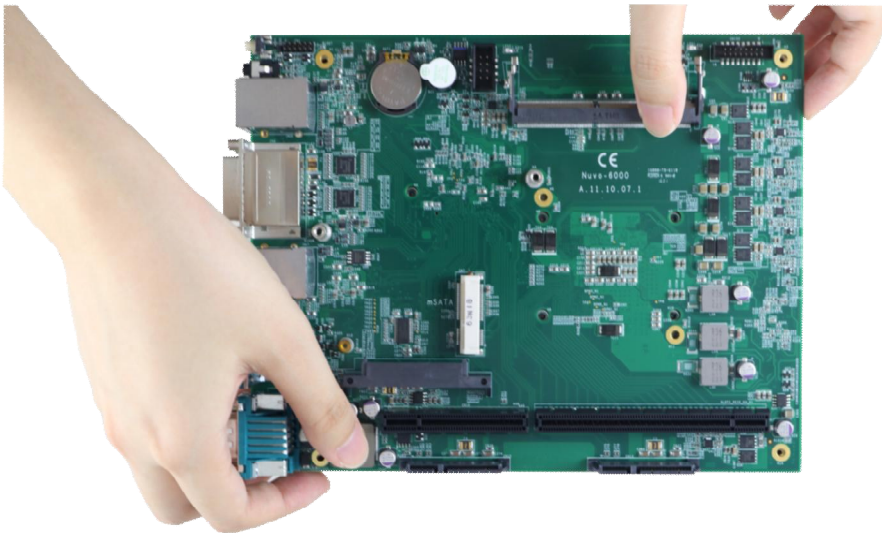

- Get five M3 spring screws from the accessory box. Fix them according to the order indicated on the photo (yellow circles). And tighten four M3 P-head screws (red circles) to fix the PCBA to the heat-sink.

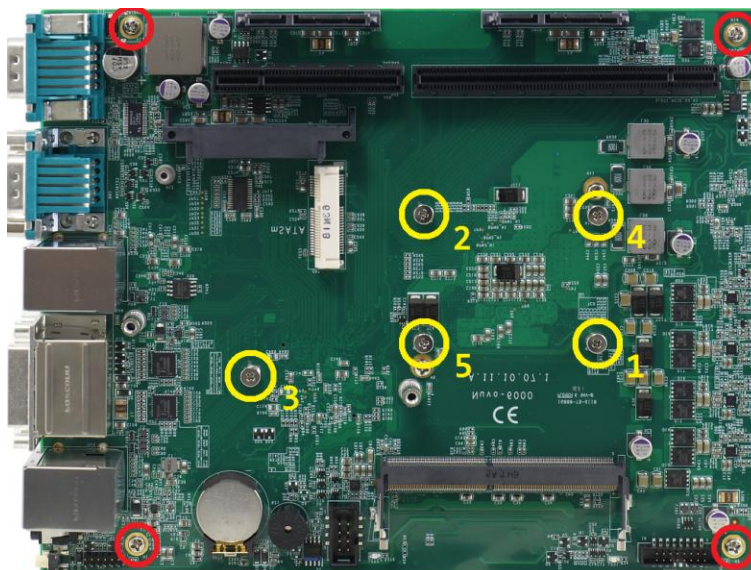



## 3.2.2 Replace the CPU on Nuvo-6000

User should take extra care when replacing the CPU to avoid possible damage on SBC or the CPU socket. Please exactly follow instructions described in this section to replace the CPU on your Nuvo-6000 controller.

### Caution

*Please make sure the PCBA/heat-sink assembly is cooled down to room temperature before you proceed with the installation/replacement procedures. Replacing the CPU at high temperature may damage the system.*

1. Follow instructions described in section 3.1.2 to disassemble the heat-sink/SBC assembly from Nuvo-6000 chassis.
2. Place the heat-sink/SBC assembly on a flat surface. Remove the SBC from the heat-sink by loosening five M3 spring screws (yellow circles) and six M3 P-head (red circles).

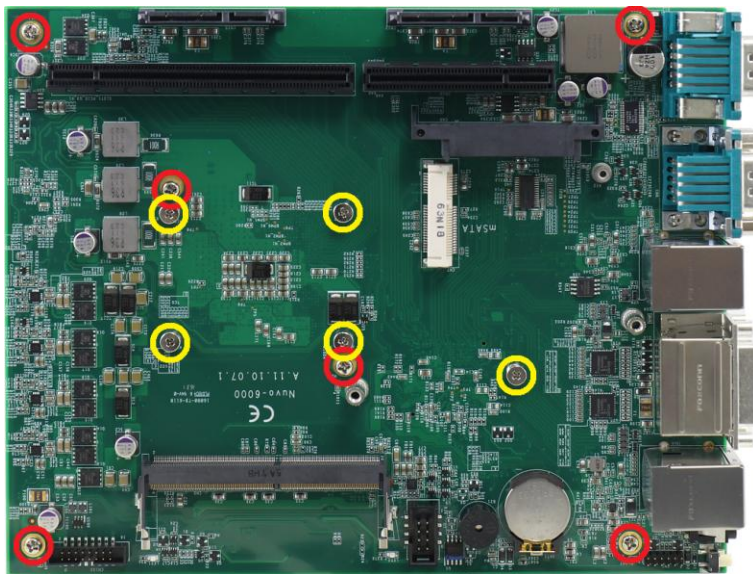

3. Gently lift the SBC from the heat-sink. The CPU and CPU retaining bracket shall stay with the heat-sink.

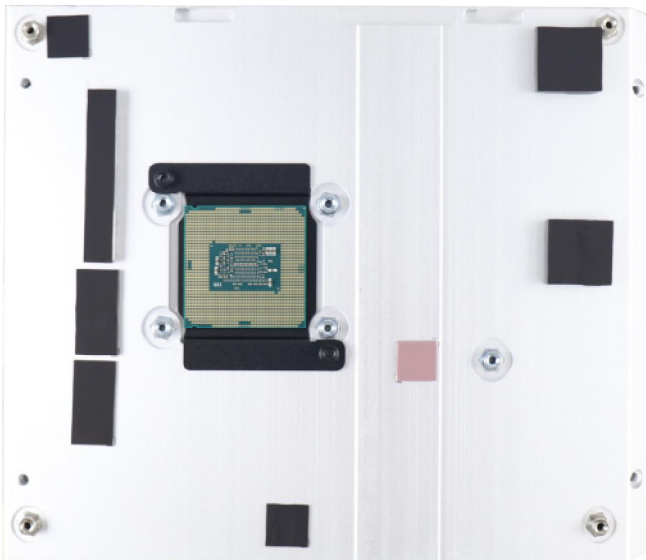
**Caution**

*When the SBC is detached and LGA1151 socket is exposed, please carefully handle the SBC to avoid any damage on LGA socket.*

4. Insert a slotted screwdriver into the gap between the CPU retaining bracket and the heat-sink, and lever the CPU bracket. Please DO NOT apply force to the CPU directly otherwise the CPU can be damage.

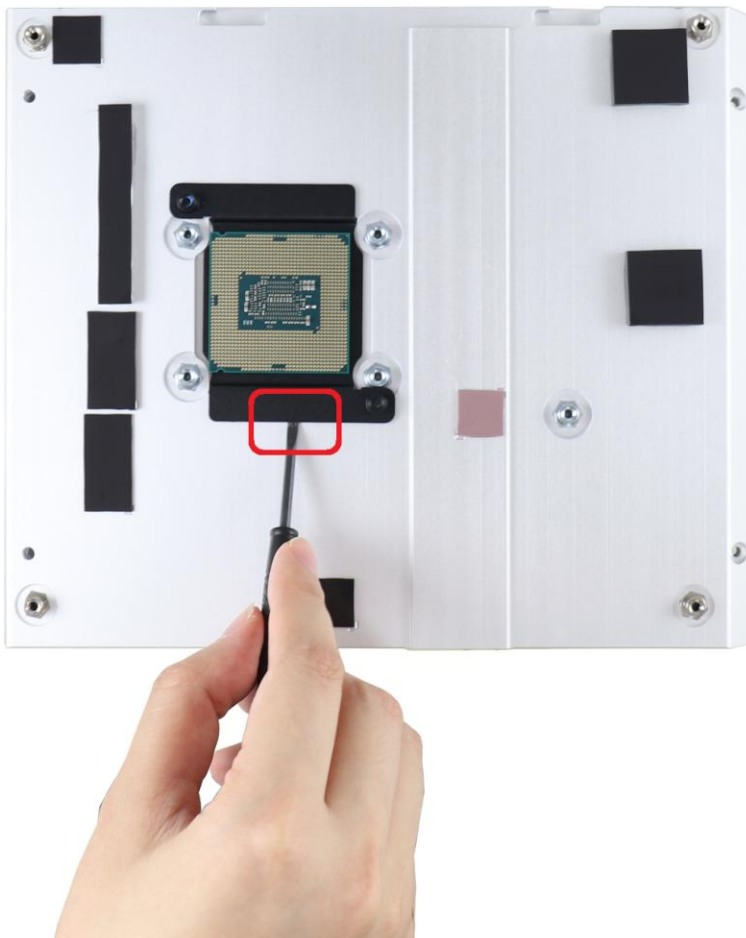

5. Check the condition of thermal pads on the heat-sink, especially the thermal pad for CPU. If it's broken, please replace it with a new one.

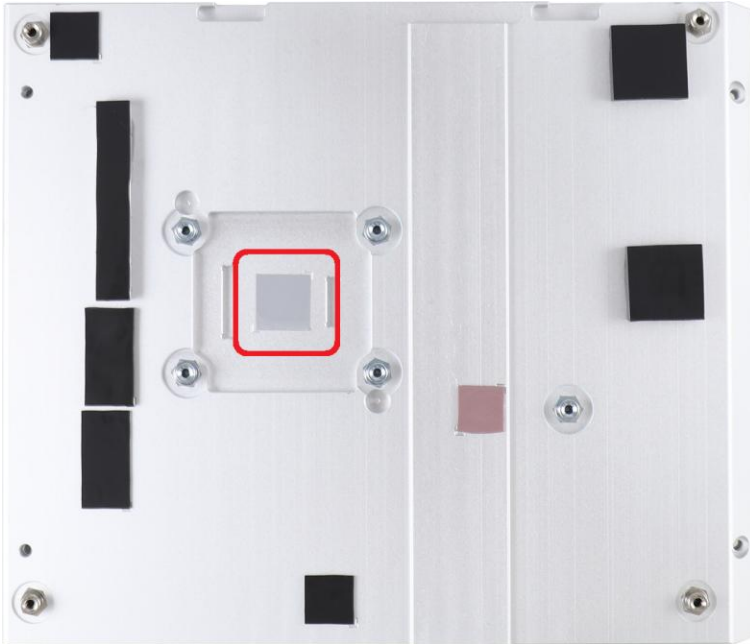

6. Follow steps described in step 5 to step 9 in section 3.2.1 to install a new CPU to your Nuvo-6000 controller.

## 3.3 Install DDR4 SODIMM Module

Nuvo-6000 series provides one 260-pin, SODIMM socket for installing DDR4 memory module. It supports maximal 16GB capacity by installing one 16 GB DDR4-2133 SODIMM modules. You can install/replace DDR4 SODIMM modules by following the steps described in this section.

1. Follow instructions described in section 3.1.1 to remove the chassis cover. You can see the DDR4 SODIMM socket on the SBC exposed.



2. Tile the SODIMM module and insert it to the SODIMM socket. As it's firmly contacted with socket connectors, press it down until the clamps of the socket snap into the latching position of SODIMM module.





## 3.4 Install mSATA SSD

Nuvo-6000 series provides a full-size mSATA socket for installing mSATA SSD. In this section, we demonstrate how to install a mSATA SSD on the Nuvo-6000 controller.

1. Follow instructions described in section 3.1.1 to remove the chassis cover. You can see the mSATA socket on the SBC exposed.

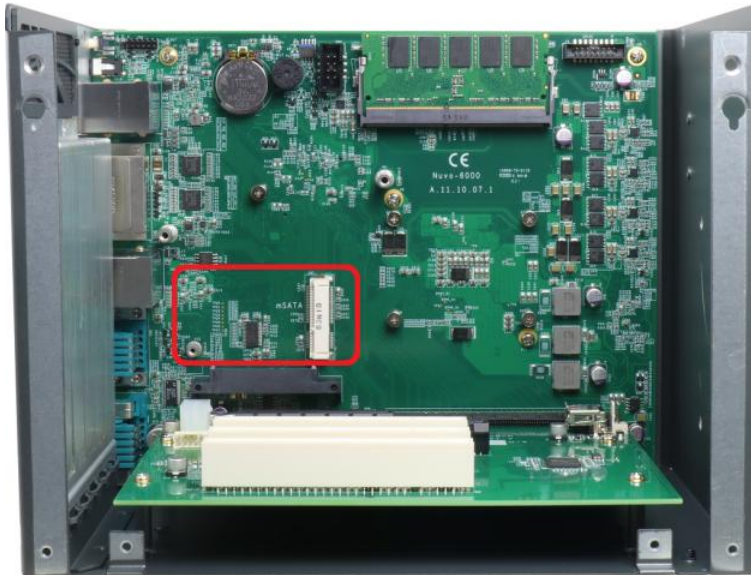

2. Tilt the mSATA SSD module and insert it into the mSATA socket. And fix the module with one M2.5 P-head screw.



## 3.5 Install 2.5" HDD/SSD

Nuvo-6000 provides totally three SATA ports. Nuvo-6032 can accommodate three 2.5" SATA hard drives and Nuvo-6002 can only accommodate one due the restriction of chassis size. In this section, we illustrate how to install 2.5" SATA HDD/SSD to your Nuvo-6000 controller.

### 3.5.1 Install 2.5" HDD/SSD to SATA Port #1

SATA port #1 is located on the SBC via a 22-pin SATA connector. You can directly mount a 2.5" HDD/SSD to this port using the HDD bracket shipped with Nuvo-6000.

1. Follow instructions described in section 3.1.1 to remove the chassis cover. You can see the SATA port #1 on the SBC.

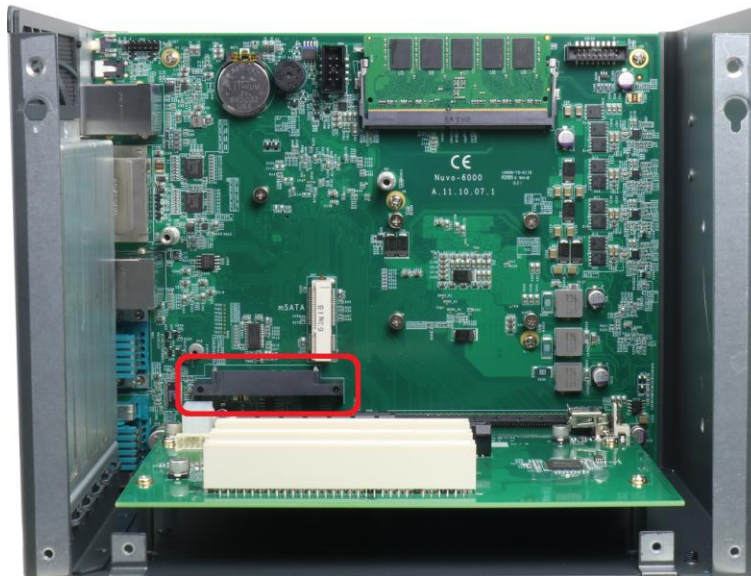

2. Get the HDD bracket from the accessory box and fix the HDD to the bracket using four M3, F-head screws.



3. Gently insert the connector of SATA HDD/SSD into the SATA port #1 and make sure it's firmly contacted. Secure the HDD/bracket assembly to the SBC using two M3, P-head screws.



### 3.5.2 Install 2.5" HDD/SSD to SATA Port #2 & #3 (Nuvo-6032 Only)

SATA port #2 and port #3 are located underneath the backplane via two 22-pin SATA connectors. You shall use the HDD tray shipped with Nuvo-6032 for the installation of 2.5" HDD/SSD.

1. Follow instructions described in section 3.1.1 to remove the chassis cover. You can see the SATA port #2 and port #3 underneath the backplane.
2. Get the HDD tray from the accessory box.



3. Place 2.5" SATA HDD/SSD on the top of HDD tray. Fix them from the opposite side using eight M3, F-head screws.





4. Align the HDD tray with guided nuts on the bottom of chassis and slide it into the chassis till SATA HDD drives are firmly attached to the connectors on SBC.

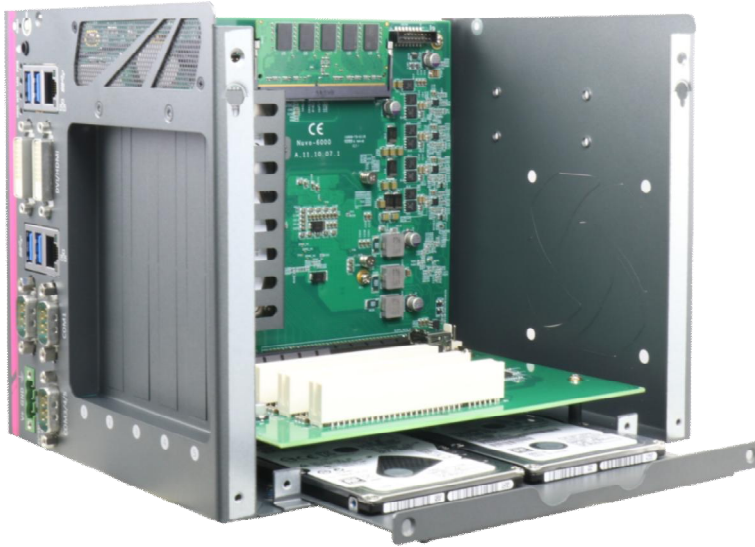

5. Secure the HDD/tray assembly to the chassis using two M3, F-head screws.

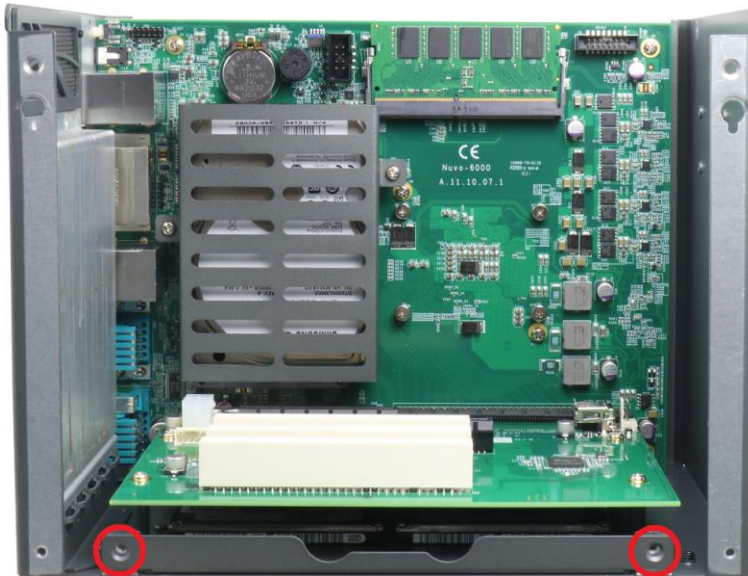

## 3.6 Install PCI/PCIe Add-on Card

Nuvo-6000 series provides PCI and PCIe slots on its backplane. Nuvo-6032 provides one x16 PCIe slot, one x8 slot and three 5V, 33MHz/32-bit PCI slots, as Nuvo-6002 provides one x16 PCIe slot and one x8 PCIe slot. The maximum allowable length of a add-on card to be installed into Nuvo-6000 is varied depending on whether the optional fan is installed. Please refer the following table to understand the restriction of dimension for add-on cards.

	Maximum Allowable Dimension (L x H)
Without optional fan installed	205 mm x 140 mm
With optional fan installed	185 mm x 140 mm

To install a PCI/PCIe add-on card, please follow the steps listed below.

1. Follow instructions described in section 3.1.1 to remove the chassis cover. You can see the PCI/PCIe slots on the backplane. You should also remove the panel bracket of the slot for installation.



2. Install your add-on card into the PCI/PCIe slot. Make sure the “golden finger” connector is firmly contacted with PCI/PCIe connector and the faceplate of the add-on card is well inserted to the groove underneath.

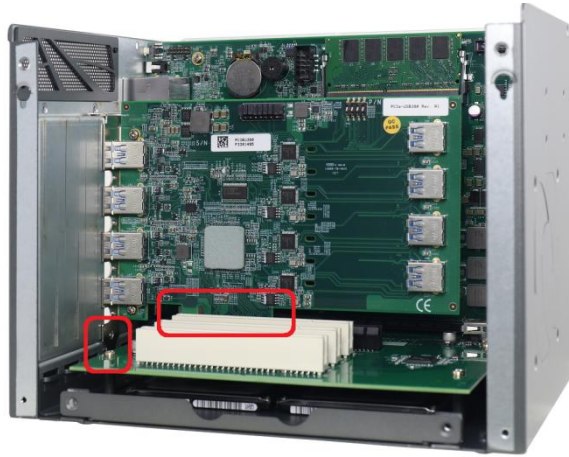
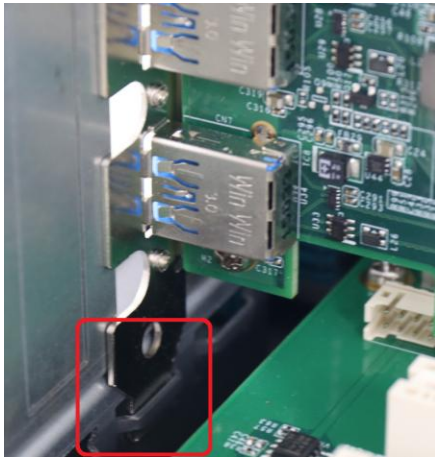

3. Fix the PCI/PCIe add-on card using the M3, PW-head screw.



## 3.7 Install Optional Fan

When an add-on card with higher power consumption (e.g. PCIe graphics card) installed in Nuvo-6000, you shall install a fan for heat dissipation. Neosys offers a fan option, as a general solution for versatile add-on cards, to create active air flow and maintain proper temperature. The speed of fan is controlled automatically according to the temperature inside the chassis. Users can set two trip points in BIOS setup menu. At the trip point 1 (Fan Start Trip Point), fan start to rotate at 20% speed. The fan speed increases gradually to 100% at trip point 2 (Fan Max. Trip Point). By this mean you can have a quieter fan operation and longer life for fan. Please refer to section 4.1.4 for information regarding configuring trip points for optional fan.

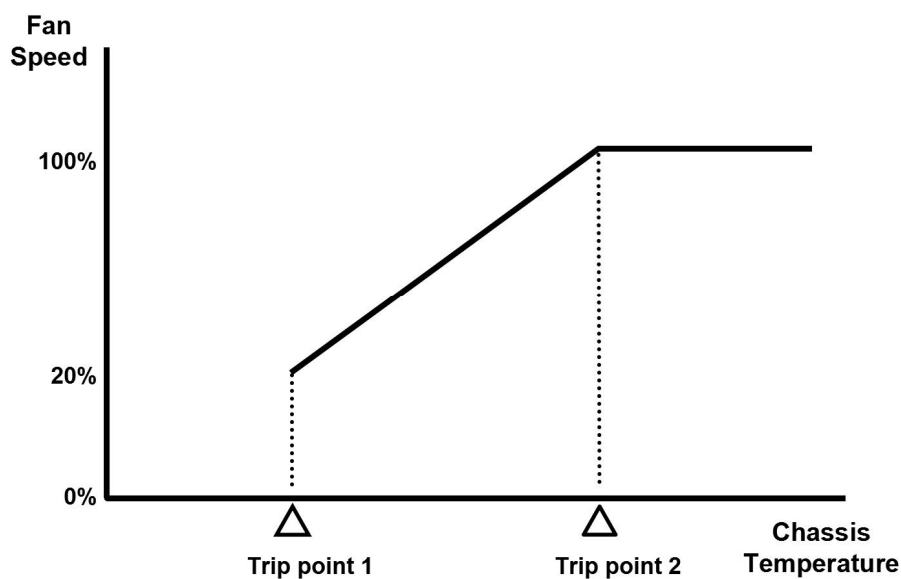

To install the optional fan, please follow the steps listed below.

1. Follow instructions described in section 3.1.1 to remove the chassis cover.
2. Remove pre-cutting plates for fan apertures on the back of chassis.



3. Align fixing holes of the fan to fixing holes on the back of chassis. Please make sure you have correct installation direction for fan as shown in the photo. The air flow must be from inside to outside. And plug the power connector of fan into the fan power receptacle on the backplane.



4. Fix the fan from outside using four F-head screws.

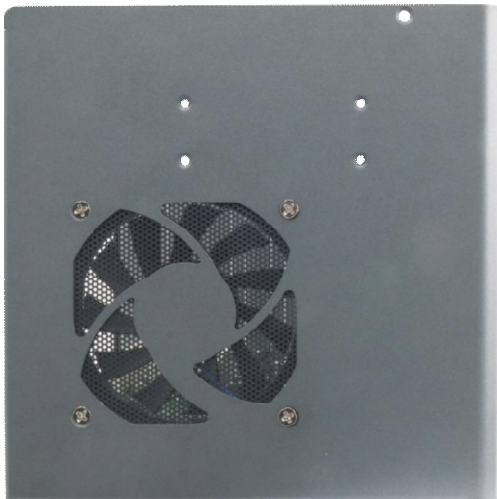



## 3.8 Mount your Nuvo-6000

Nuvo-6000 provides versatile ways of mounting. You can use wall-mounting brackets shipped with Nuvo-6000 to mount it on a wall or a flat surface. Neusys also offers optional DIN rail clip to mount Nuvo-6000 on a DIN rail. Or use an optional rack-mounting kit to install your Nuvo-6000 into a rack. To mount your Nuvo-6000, please refer to the information listed below.

### 3.8.1 Mount your Nuvo-6032 on the Wall

1. Get one wall-mounting bracket and four M4 screws from the accessory box. Fix the mounting bracket to the back side of Nuvo-6032 using four M4 screws.

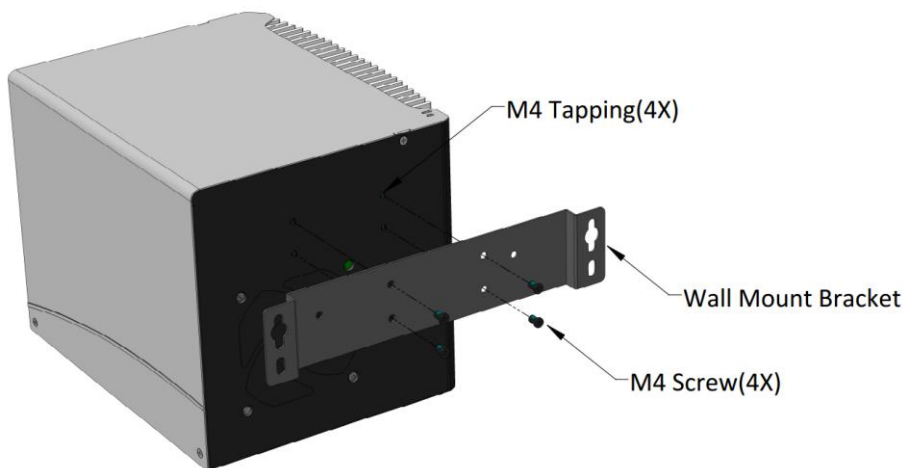

2. Fix Nuvo-6032 on the wall via the screw holes of the mounting bracket. You can also take advantage of the keyhole-shaped holes of the mounting bracket to suspend Nuvo-6032 on the Wall.

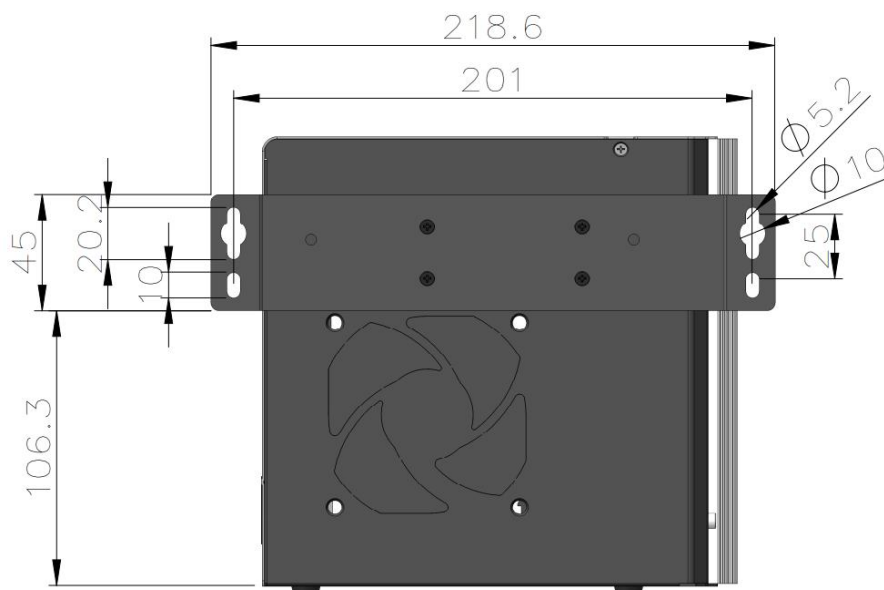

### 3.8.2 Mount your Nuvo-6032 on a Flat Surface

1. Get two wall-mounting brackets and four M4 screws from the accessory box. Fix the mounting brackets to the bottom side of Nuvo-6032 using M4 screws.

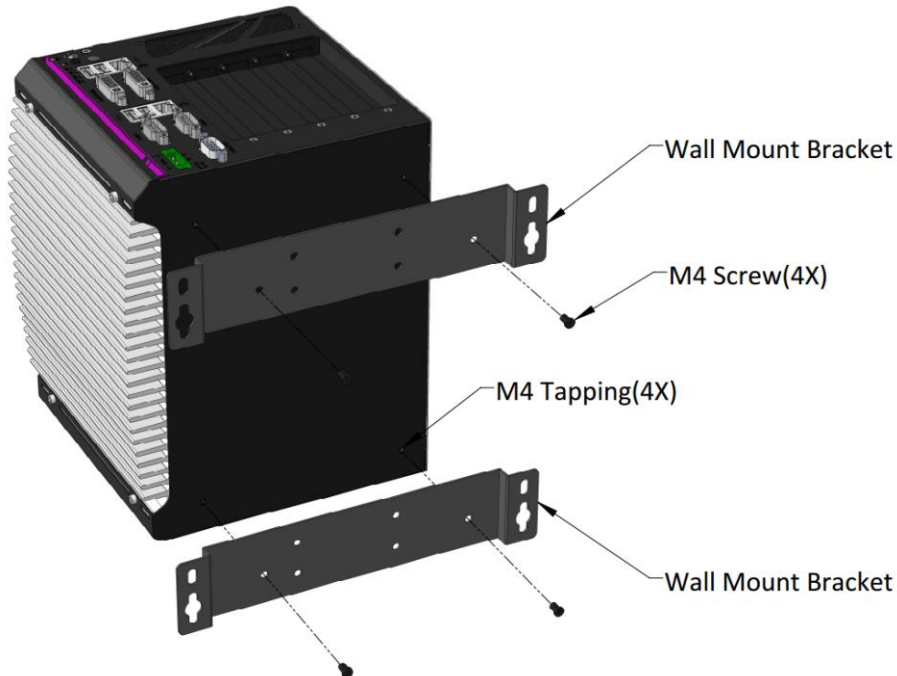

2. Fix Nuvo-6032 on a flat surface via the screw holes of two mounting brackets.

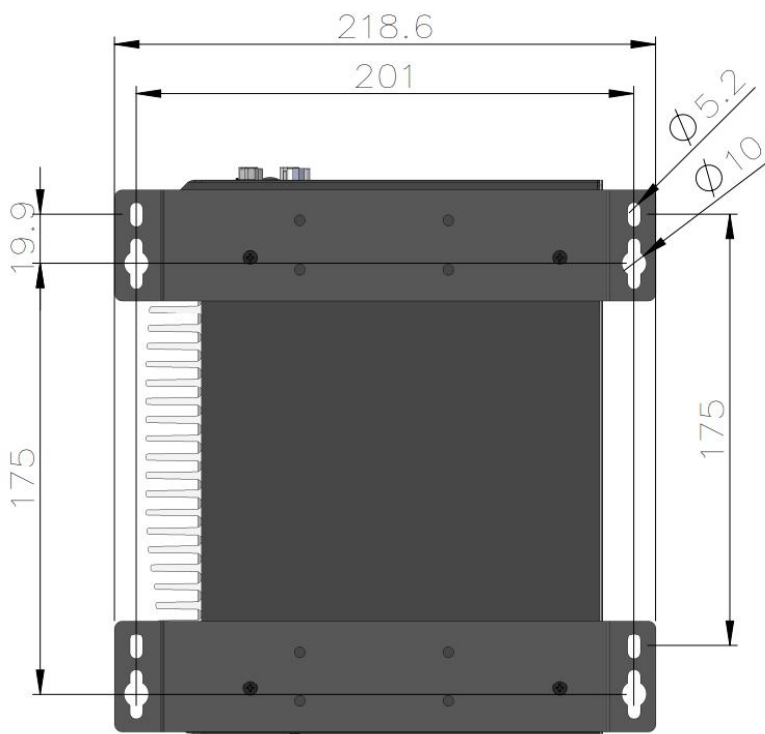



### 3.8.3 Mount your Nuvo-6032 on the DIN Rail

Neusys provides the option of the DIN-rail mounting clip. You should fix the clip to Nuvo-6032 using four M4 screws before mount it to a DIN rail. This option can be useful if you want to deploy Nuvo-6032 inside an equipment cabinet where DIN rail is available.

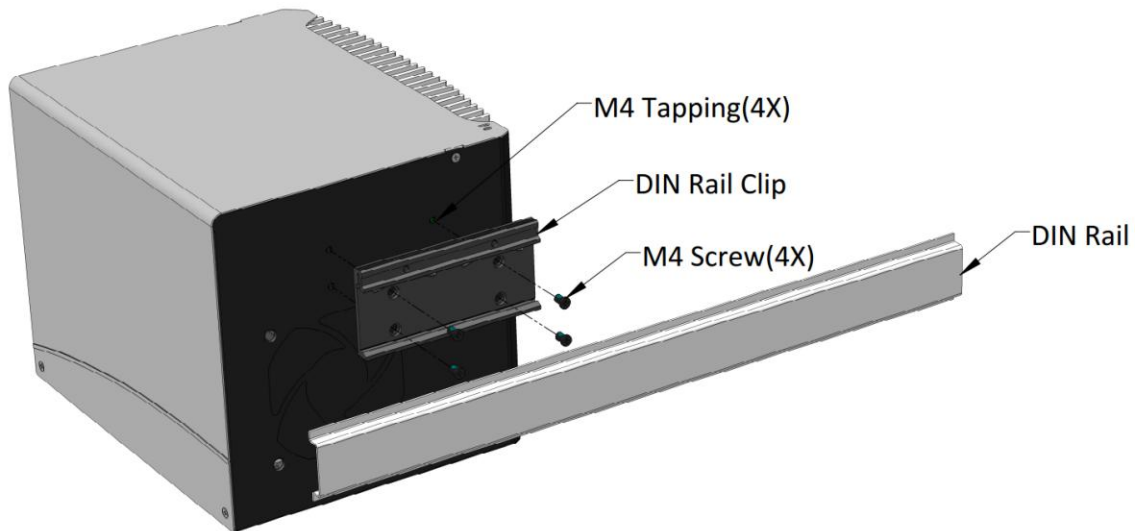

### 3.8.4 Mount your Nuvo-6032 into a Rack

Neusys provides the option of the rack mounting kit for installing Nuvo-6000 into a rack. The assembly of Nuvo-6000 and rack mounting kit occupies 19", 4U space. The rack mounting kit is designed to support both forward and backward mounting. You can have Nuvo-6000 toward front side or back side of the rack. Please refer to the following steps to mount your Nuvo-6032 into a rack.

1. Apply 10x M4 flat-head screws to fix the side plates to the bottom plate as the illustration below.

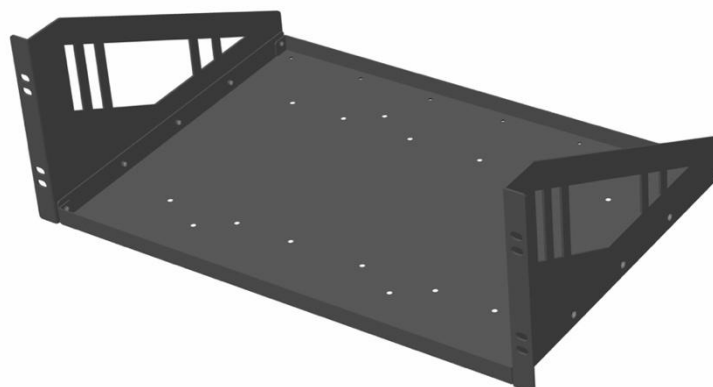
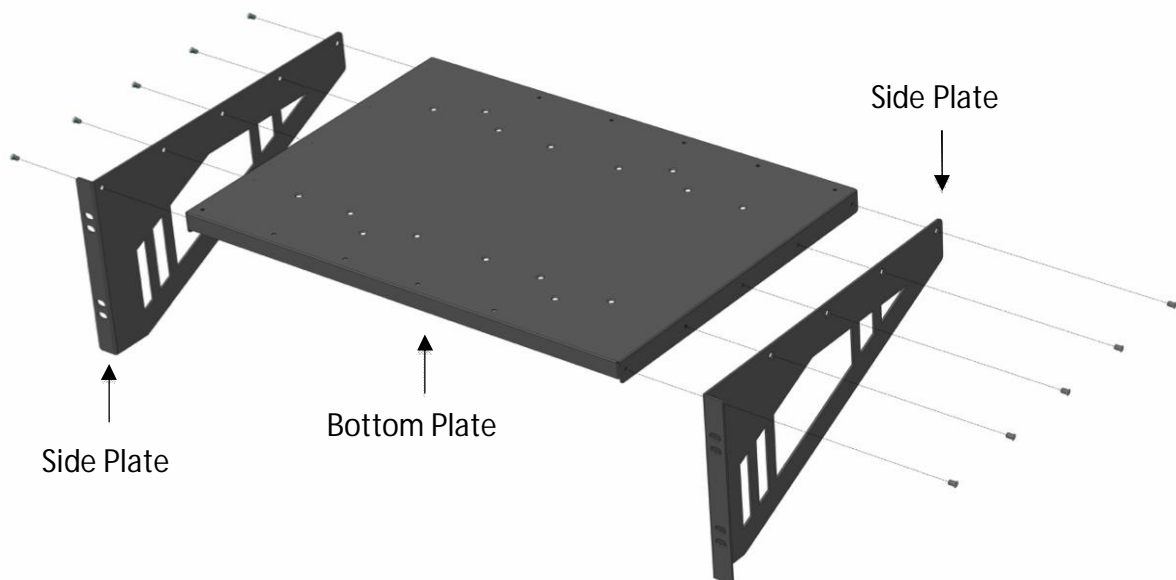

2. Please Nuvo-6032 upside down on a flat surface and remove four foot pads on the



bottom side.

3. Align the screws holes on the bottom side of Nuvo-6032 to the holes of bottom plate of rack mounting kit (marked as red below). And fix them with eight M4, flat-head screws.

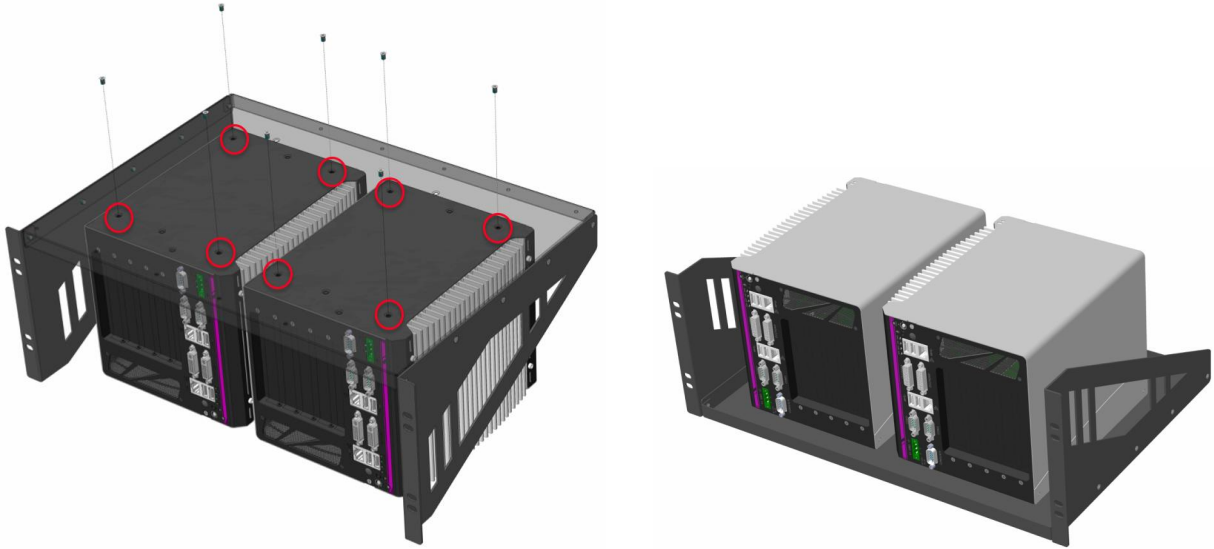

4. You can also place Nuvo-6032 toward the back side and fix it to the rack mounting kit.

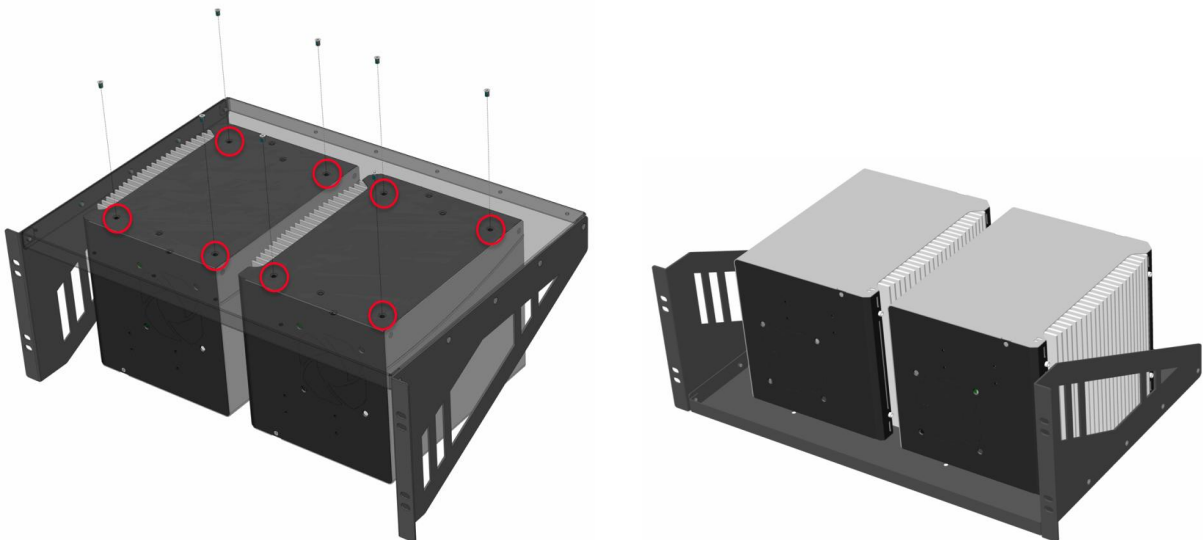

### 3.8.5 Mount your Nuvo-6002 on the Wall

1. Get one wall-mounting bracket and four M4 screws from the accessory box. Fix the mounting bracket to the back side of Nuvo-6002 using M4 screws.

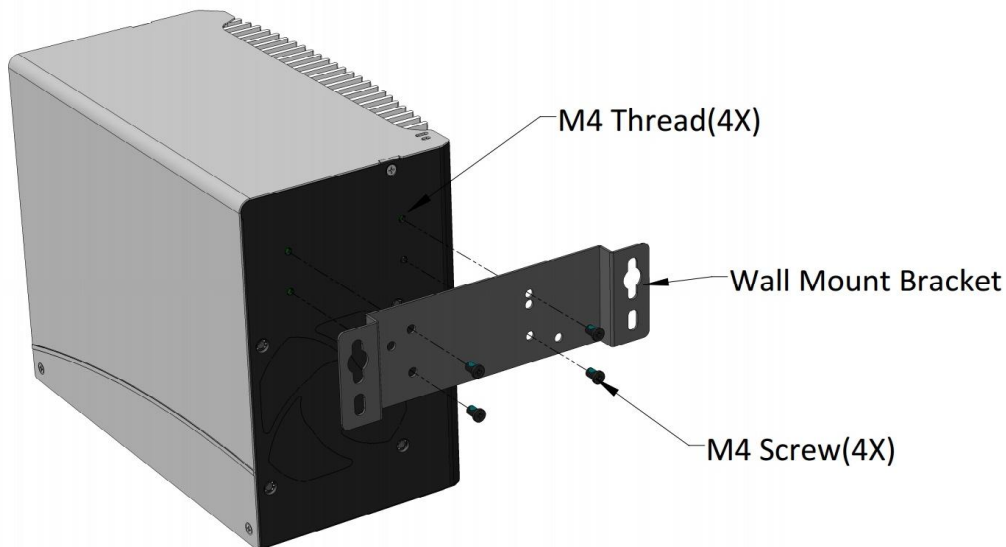

2. Fix Nuvo-6002 on the wall via the screw holes of the mounting bracket. You can also take advantage of the keyhole-shaped holes of the mounting bracket to suspend Nuvo-6002 on the Wall.

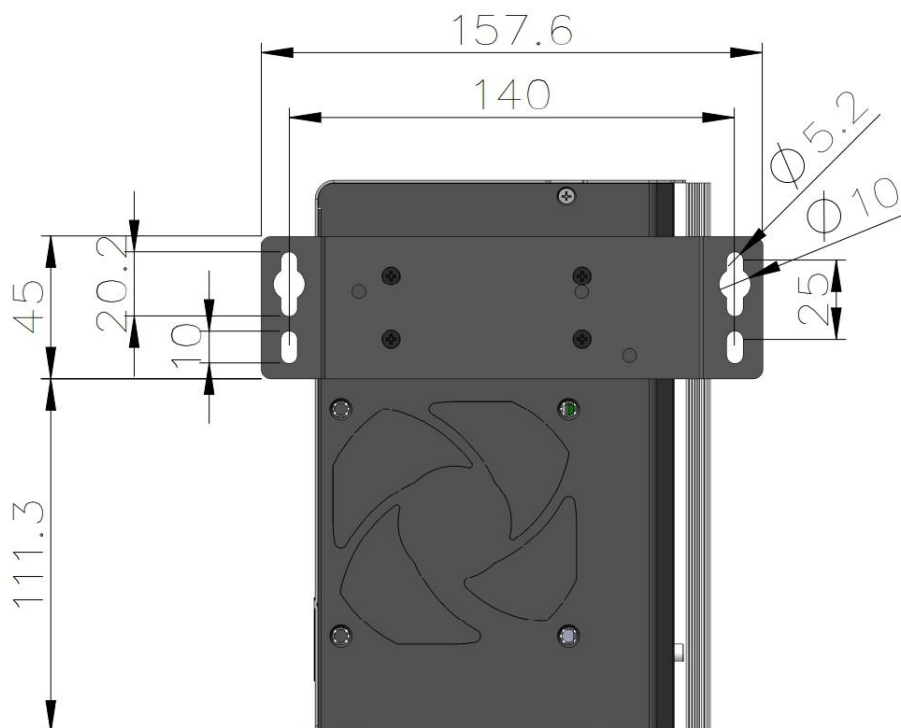

### 3.8.6 Mount your Nuvo-6002 on a Flat Surface

1. Get two wall-mounting brackets and four M4 screws from the accessory box. Fix the mounting brackets to the bottom side of Nuvo-6002 using M4 screws.

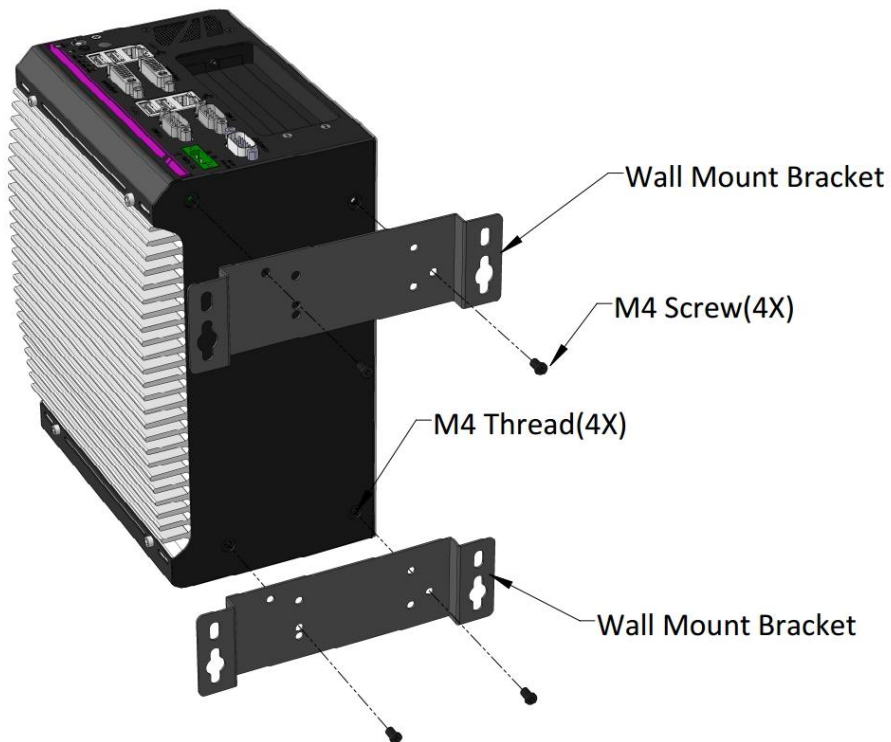

2. Fix Nuvo-6002 on a flat surface via the screw holes of two mounting brackets.

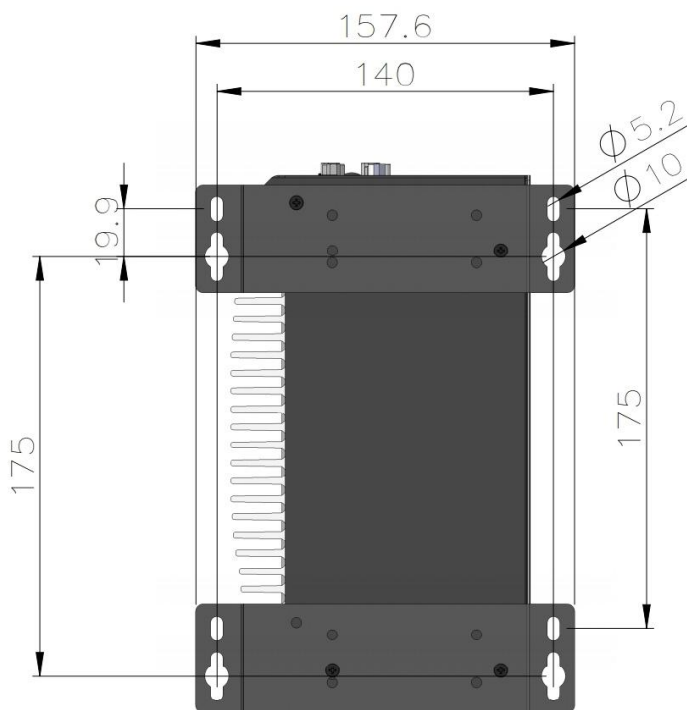

### 3.8.7 Mount your Nuvo-6002 on a DIN Rail

Neusys provides the option of the DIN-rail mounting clip. You should fix the clip to Nuvo-6002 using four M4 screws before mount it to a DIN rail. This option can be useful if you want to deploy Nuvo-6002 inside an equipment cabinet where DIN rail is available.

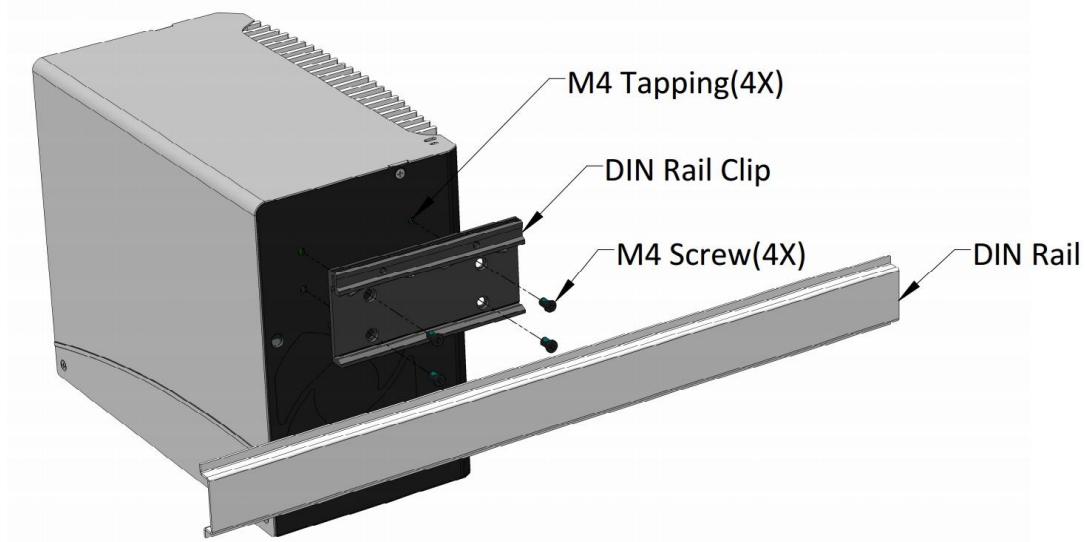

### 3.8.8 Mount your Nuvo-6002 into a Rack

Neusys provides the option of the rack mounting kit for installing Nuvo-6000 into a rack. The assembly of Nuvo-6000 and rack mounting kit occupies 19", 4U space. The rack mounting kit is designed to support both forward and backward mounting. You can have Nuvo-6000 toward front side or back side of the rack. Please refer to the following steps to mount your Nuvo-6002 into a rack.

1. Apply 10x M4 flat-head screws to fix the side plates to the bottom plate as the illustration below.

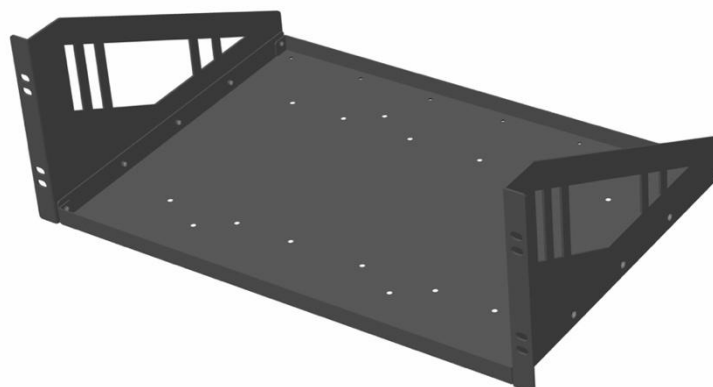
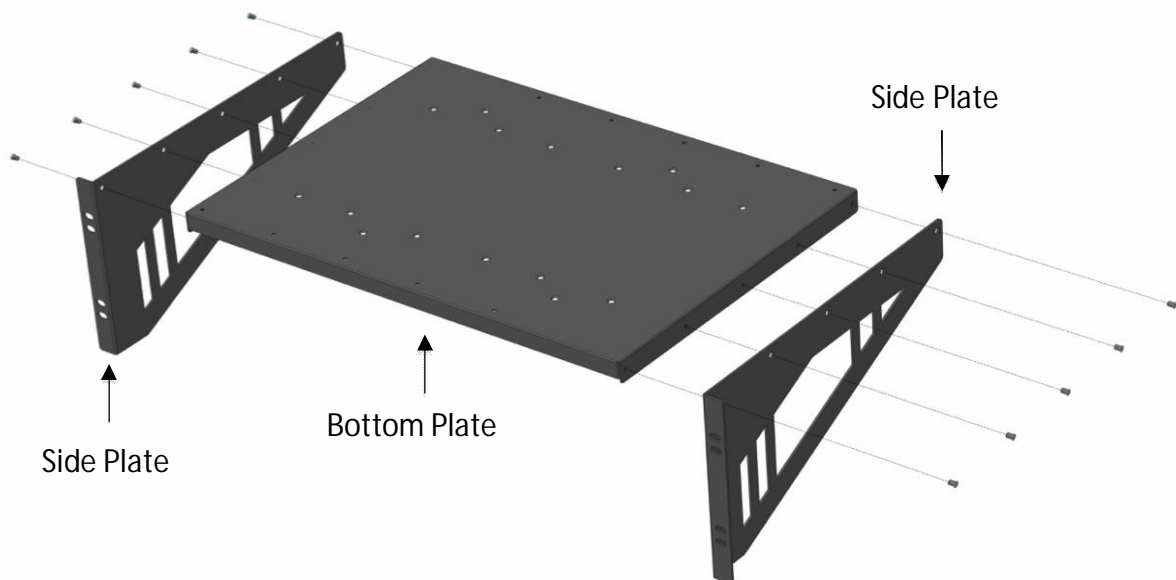



2. Please Nuvo-6002 upside down on a flat surface and remove four foot pads on the bottom side.
3. Align the screws holes on the bottom side of Nuvo-6002 to the holes of bottom plate of rack mounting kit (marked as red below). And fix them with eight M4, flat-head screws.

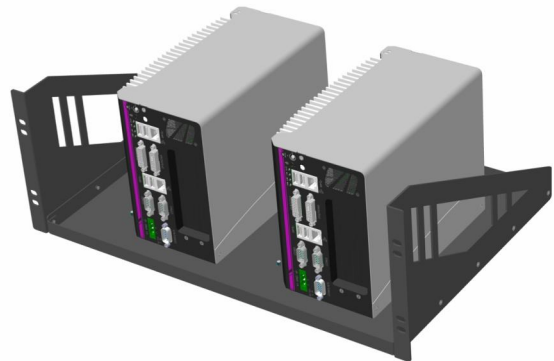
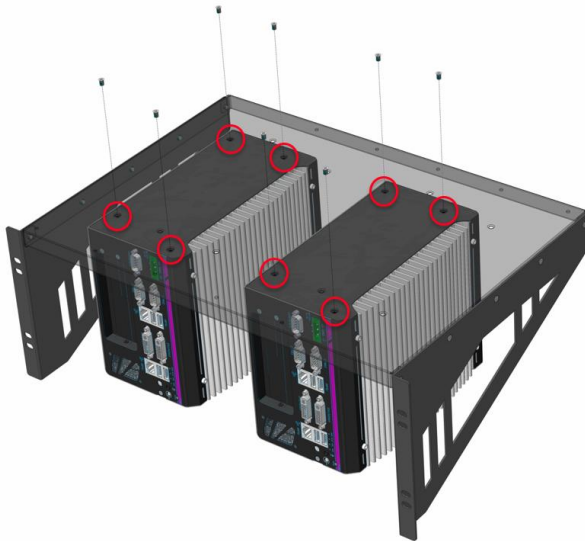

4. You can also place Nuvo-6002 toward the back side and fix it to the rack mounting kit.

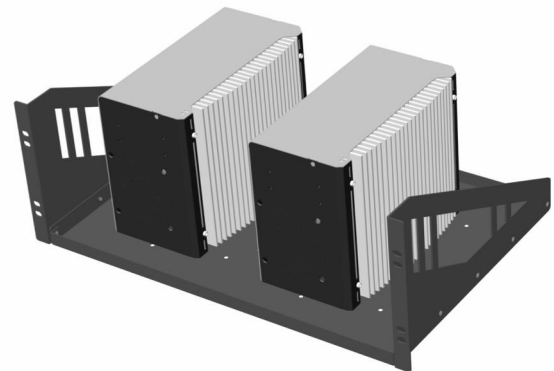
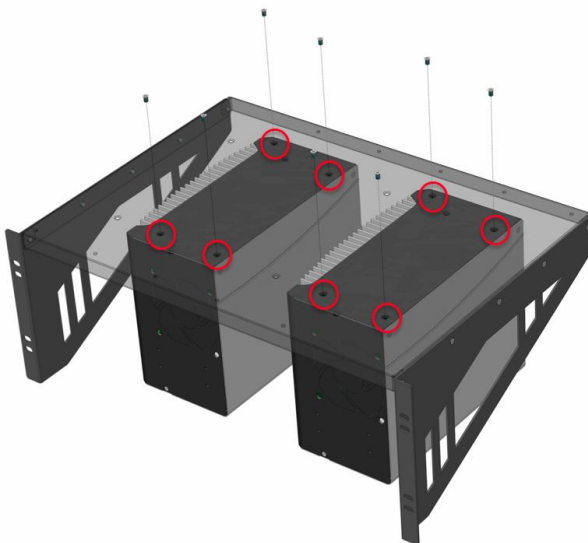

## 3.9 Connect DC power to you Nuvo-6000

Nuvo-6000 series uses a 3-pin pluggable terminal block to accept 8~35V DC power input. It provides the reliable way for directly wiring the DC power. To supply DC power via the 3-pin pluggable terminal block, please follow the steps described below.

1. Make sure the external DC power supply is power off or disconnected before wiring.
2. Get the 3-pin pluggable terminal block from the accessory box. The terminal block fits the wires with a gauge of 12~24 AWG.
3. Carefully identify the positive and negative contacts of your DC power supply and pluggable terminal block. The polarities between DC power supply and terminal block must be positive (+) to positive (+) and ground (GND) to ground (GND).



4. Insert the wires to correct contacts of pluggable terminal block and tighten clamping screws using a Philips screwdriver.
5. Firmly plug the terminal block into a receptacle on the front panel, and tighten the captive screws using a Slotted screwdriver.



### Caution

1. *Nuvo-6000 series accepts 8~35 VDC when using terminal block for DC input. Please make sure the voltage and polarity of DC power is correct before you connect it to Nuvo-6000 controller. Supplying a voltage over 35V or incorrect polarity will damage the system.*

## 3.10 Power on your Nuvo-6000

For better flexibility of operation, Nuvo-6000 series provides two alternatives to power on your Nuvo-6000 controller. You can turn on your Nuvo-6000 controller by simply pressing the power button, or by sending a special LAN packet. In this section, we illustrate these ways to power on your Nuvo-6000 controller.

### 3.10.1 Power on Nuvo-6000 Using the Power Button

This is the simplest way to turn on your Nuvo-6000 controller. The power button on the front panel is a non-latched switch and behaves the ATX-mode on/off control. As DC power is connected, push the power button will turn on the system as well as the PWR LED indicator. Push the button when system is on will turn off the system. If your operating system supports ATX power mode (i.e. Microsoft Windows or Linux), push the power button causes a pre-defined system behavior, such as shutdown or hibernation.



### 3.10.2 Power on Nuvo-6000 Using Wake-on-LAN Function

Wake-on-LAN (WOL) is a mechanism to wake up a computer system from a S5 (system off with standby power) state via issuing a magic packet. Nuvo-6000 series implements the Wake-on-LAN function on the I219-LM GbE port as marked below.

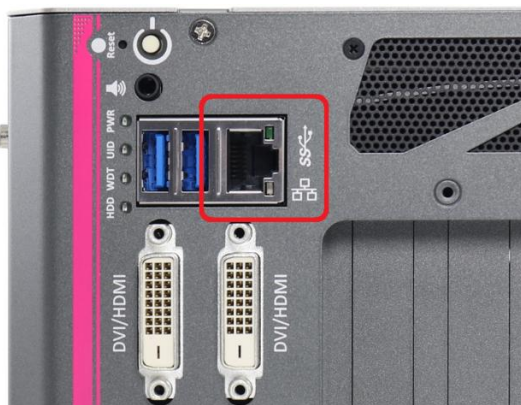

To enable WOL function and power on you Nuvo-6000 controller, please follow the steps described below.

1. When Nuvo-6000 controller boots up, press F2 to enter BIOS setup utility.
2. Enter the **[Power]** menu. And configure the **[Wake On LAN]** option as **[Enabled]**. This setting enables the Wake-on-LAN function for Nuvo-6000 series. Please refer to section 4.1.6 for the instruction of configuring this BIOS option.
3. In Windows 7 system, identify the Local Area Connection of corresponding Intel® I219 Gigabit Controller and click the **Configure** button.

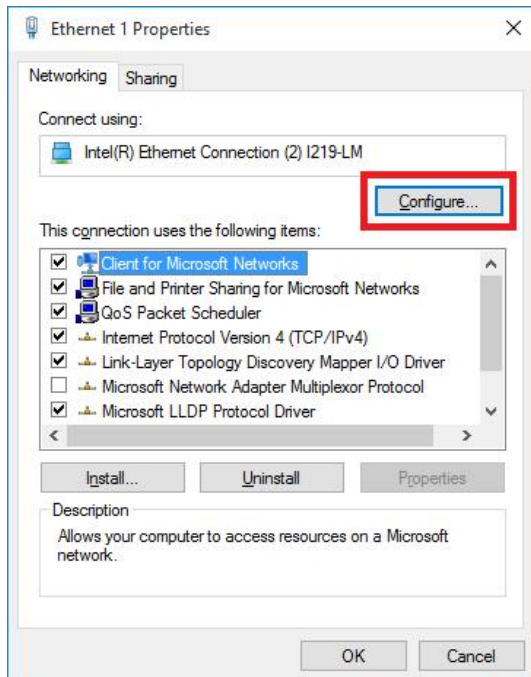

4. Click the **Power Management** tag, and check the following two options accordingly

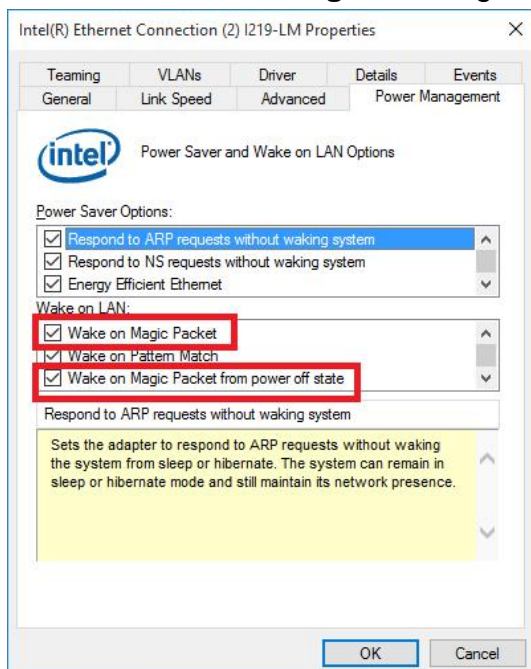

- **Wake on Magic Packet**



Nuvo-6000 series can wake from S5 state when receiving a magic packet. The magic packet is a broadcast frame containing anywhere within its payload 6 bytes of all 255 (FF FF FF FF FF FF in hexadecimal), followed by sixteen repetitions of the target computer's 48-bit MAC address.

For example, NIC's 48-bit MAC Address is 78h D0h 04h 0Ah 0Bh 0Ch

DESTINATION	SOURCE	MISC
FF FF FF FF FF FF		
78 D0 04 0A 0B 0C	78 D0 04 0A 0B 0C	
78 D0 04 0A 0B 0C	78 D0 04 0A 0B 0C	
78 D0 04 0A 0B 0C	78 D0 04 0A 0B 0C	
78 D0 04 0A 0B 0C	78 D0 04 0A 0B 0C	
78 D0 04 0A 0B 0C	78 D0 04 0A 0B 0C	
78 D0 04 0A 0B 0C	78 D0 04 0A 0B 0C	
78 D0 04 0A 0B 0C	78 D0 04 0A 0B 0C	
78 D0 04 0A 0B 0C	78 D0 04 0A 0B 0C	
MISC	CRC	

There are some free tools available on Internet that can be used to send a magic packet. Please refer to the following link to understand more about Magic Packet.  
<http://en.wikipedia.org/wiki/Wake-on-LAN>



# Chapter 4 BIOS and Driver

## 4.1 BIOS Settings

Nuvo-6000 is shipped with factory-default BIOS settings cautiously programmed for best performance and compatibility. In this section, we'll illustrate some of BIOS settings you may need to modify. Please always make sure you understand the effect of change before you proceed with any modification.

### 4.1.1 COM1 & COM2 Operating Mode

COM1/COM2 of Nuvo-6000 supports RS-232 (full-duplex), RS-422 (full-duplex) and RS-485 (half-duplex) mode. You can set the COM1/COM2 operating mode via BIOS settings. Another option in BIOS called "Slew Rate" defines how sharp the rising/falling edge is for the output signal of COM1/COM2. For long-distance RS-422/485 transmission, you may set the "Slew Rate" option as "High" to improve signal quality.

To set COM1/COM2 operating mode:

1. When Nuvo-6000 boots up, press F2 to enter BIOS setup utility.
2. Go to **[Advanced]** → **[Peripheral Configuration]**.
3. Set the **[Set COM1 as]** to a proper mode for COM1 of your Nuvo-6000.
4. Set the **[Set COM2 as]** to a proper mode for COM2 of your Nuvo-6000.

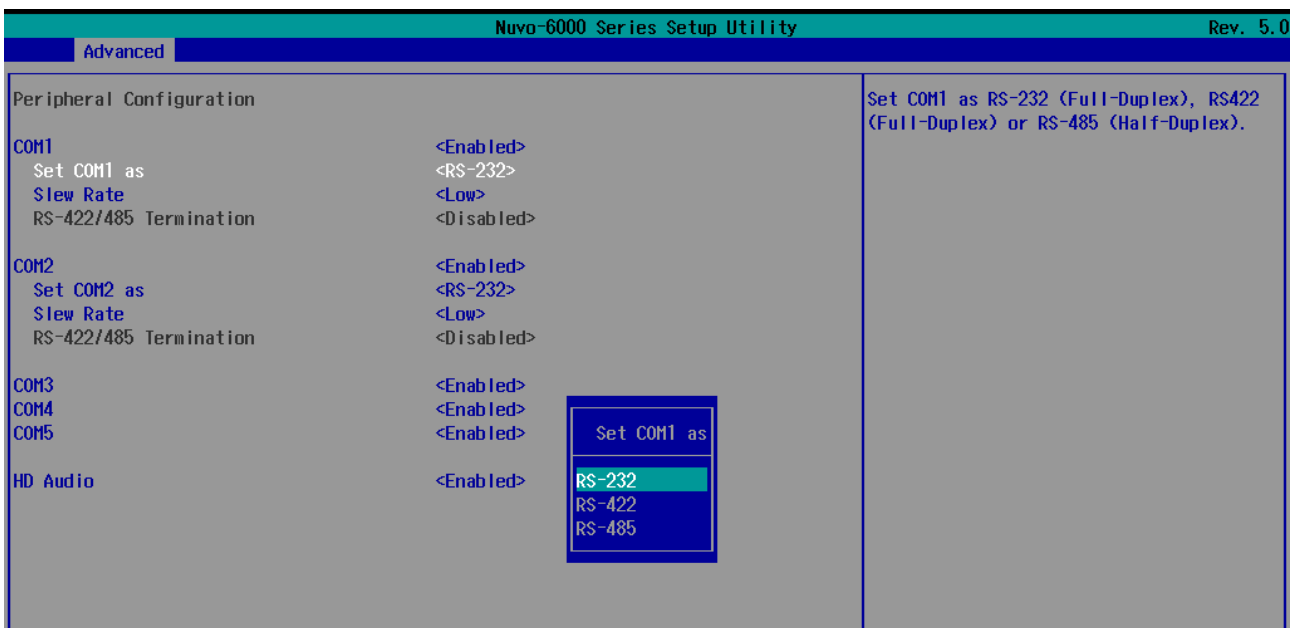



## 4.1.2 Set Link Speed for x16 PCIe Slot

The x16 PCIe slot on Nuvo-6000 is implemented via CPU's PEG port. It supports x16, Gen3 PCI Express signals. Due to the fact that some off-the-shelf PCI Express add-on cards support only Gen1/Gen2 signals using ASIC/FPGA, users may encounter compatibility issue. In this case, you can manually set the link speed to eliminate the compatibility issue.

To set link speed for x16 PCIe slot:

1. When Nuvo-6000 boots up, press F2 to enter BIOS setup utility.
2. Go to **[Advanced]** → **[System Agent (SA) Configuration]** → **[PEG Port Configuration]**.
3. Set the **[Max Link Speed]** to a lower speed (Gen1/Gen2) for the x16 slot.

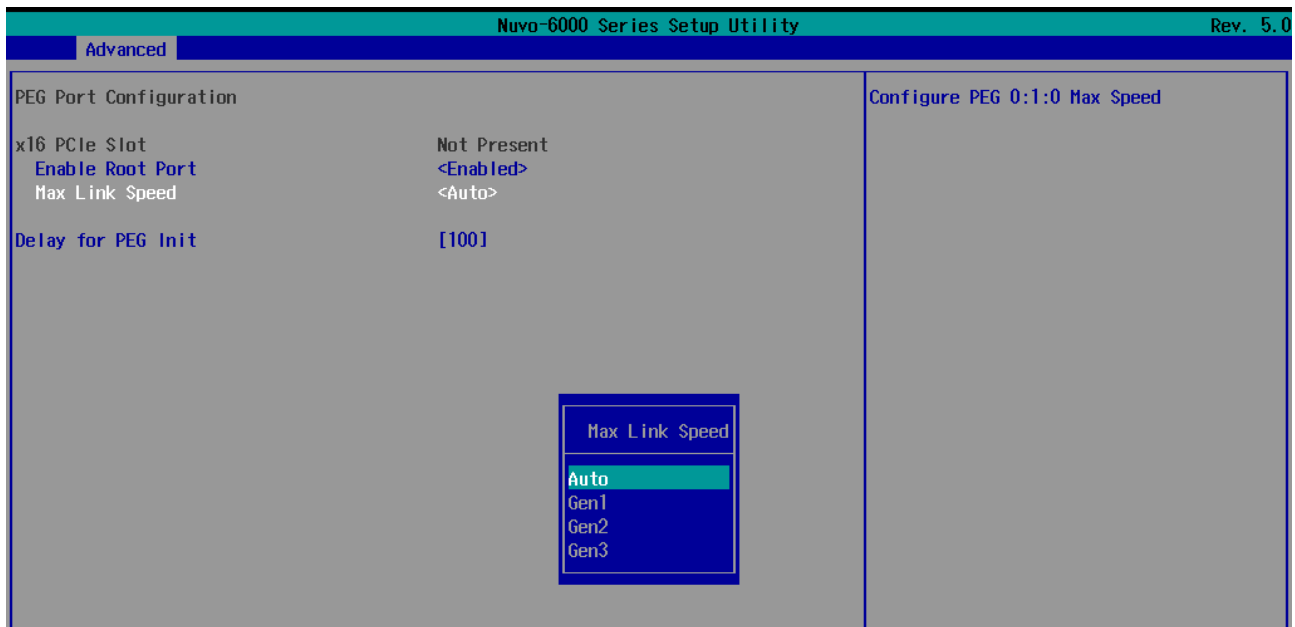

### 4.1.3 Set Link Speed for x8 PCIe Slot

The x8 PCIe slot on Nuvo-6000 is implemented via PCH's PCI Express port. It supports x4, Gen2 PCI Express signals. Due to the fact that some off-the-shelf PCI Express add-on cards support only Gen1 signals only using ASIC/FPGA, users may encounter compatibility issue. In this case, you can manually set the link speed to eliminate the compatibility issue.

To set link speed for x8 PCIe slot:

4. When Nuvo-6000 boots up, press F2 to enter BIOS setup utility.
5. Go to **[Advanced]** → **[PCI Express Configuration]** → **[x4 PCIe Port]**.
6. Set the **[PCIe Speed]** to a lower speed (Gen1) for the x8 slot.

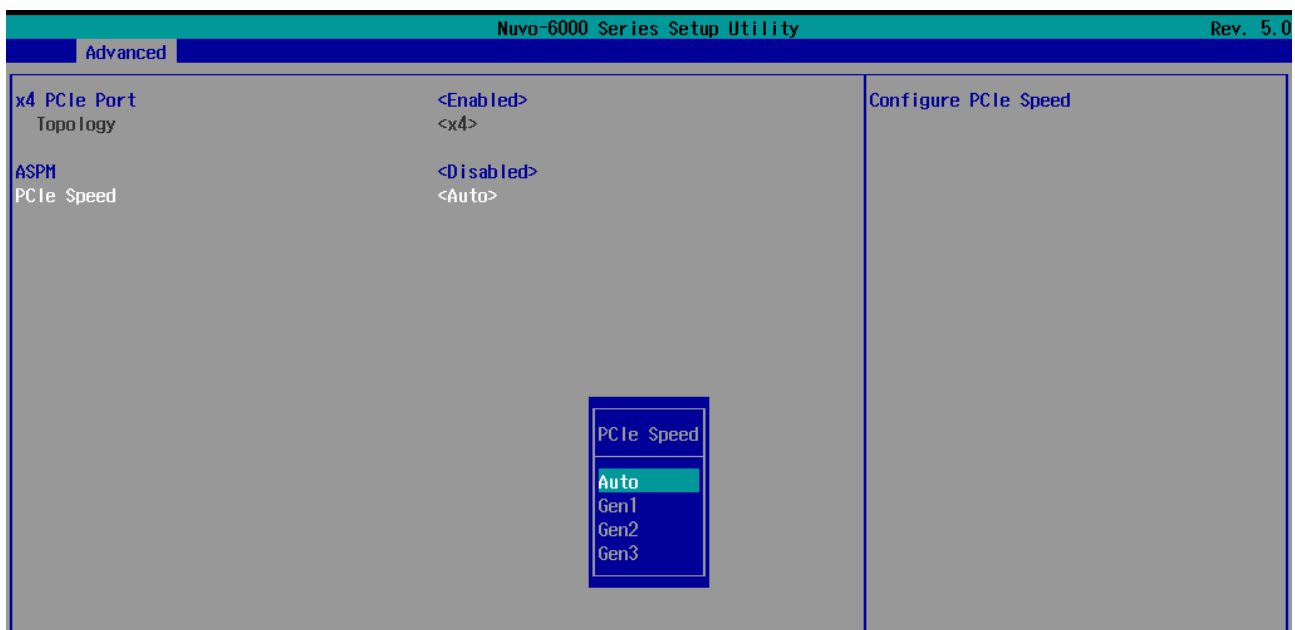

## 4.1.4 Set Trip Points for Optional Fan

Nuvo-6000 implements a smart fan control mechanism for its optional fan. By setting two trip points, users can define the profile of fan speed v.s. chassis temperature. At the trip point 1 (Fan Start Trip Point), fan start to rotate at 20% speed. The fan speed increases gradually to 100% at trip point 2 (Fan Max. Trip Point). By this mean you can have a quieter fan operation and longer life for fan.

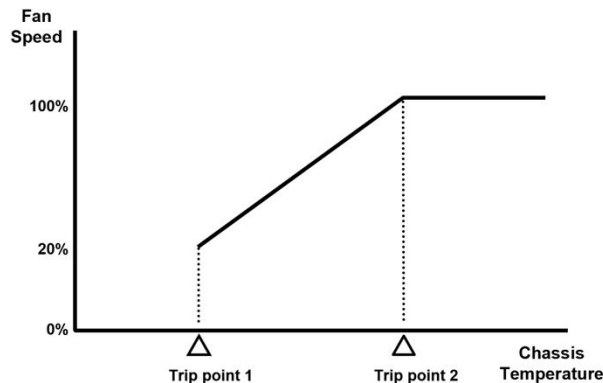

To set trip points for optional fan:

1. When Nuvo-6000 boots up, press F2 to enter BIOS setup utility.
2. Go to **[Advanced]** → **[Smart Fan Control]**.
3. Specify the **[Fan Start Trip Point]** to a value of when fan should start to rotate. The unit is degrees Celsius.
4. Specify the **[Fan Max. Trip Point]** to a value of when fan should rotate at 100% speed. The unit is degrees Celsius.

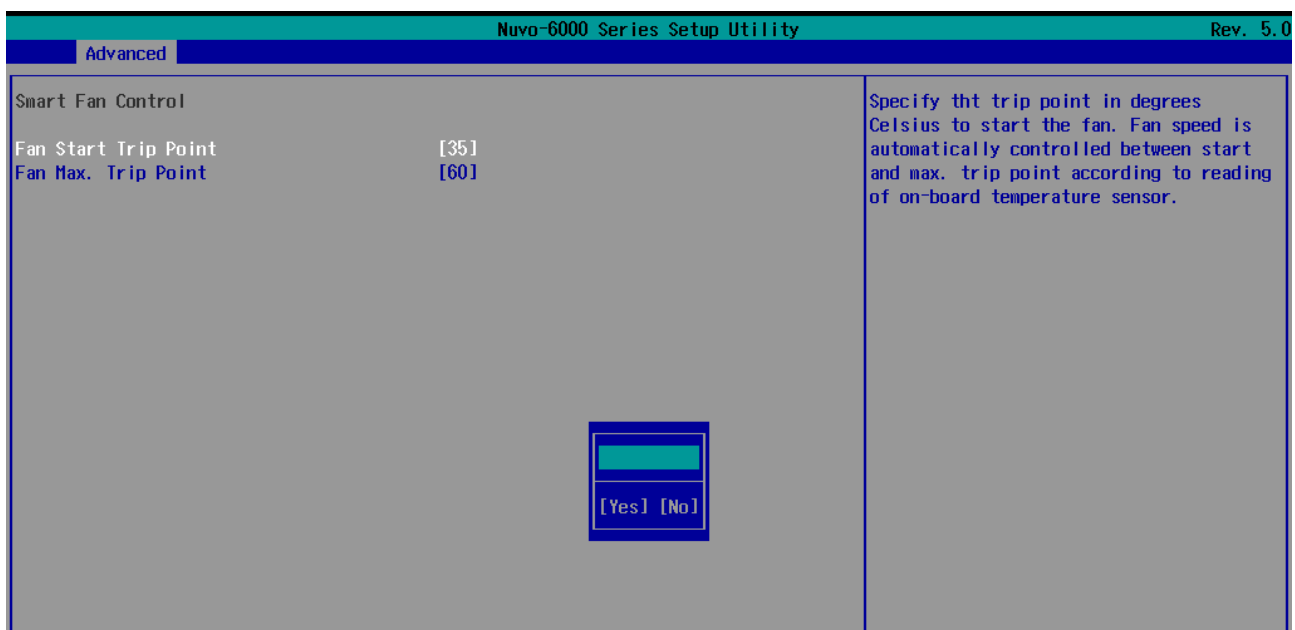

## 4.1.5 Configure CPU SKU Power

Nuvo-6000 series supports a long list of 6<sup>th</sup>-Gen Skylake LGA1151 CPU. A unique feature, “**SKU Power Config**” is implemented in BIOS to allow users to specify user-defined SKU power limit. Though Nuvo-6000 is designed to have best thermal performance with CPU of 35W TDP, you can install a 65W CPU and limit its SKU power to obtain more computing power. This feature gives you the flexibility of CPU selection and great balance between computing power and operating temperature range.

Here is our suggestion regarding specifying SKU power for system with 65W/54W/51W CPU.

- For system running at up to 60°C ambient, specify SKU power to 35 W.
- For system running at up to 50°C ambient, specify SKU power to 45 W..

To configure the CPU SKU power limit:

1. When Nuvo-6000 controller boots up, press F2 to enter BIOS setup utility.
2. Go to **[Power]** → **[Power & Performance]**.
3. Select a proper value of SKU power limit for **[SKU Power Config]** option.

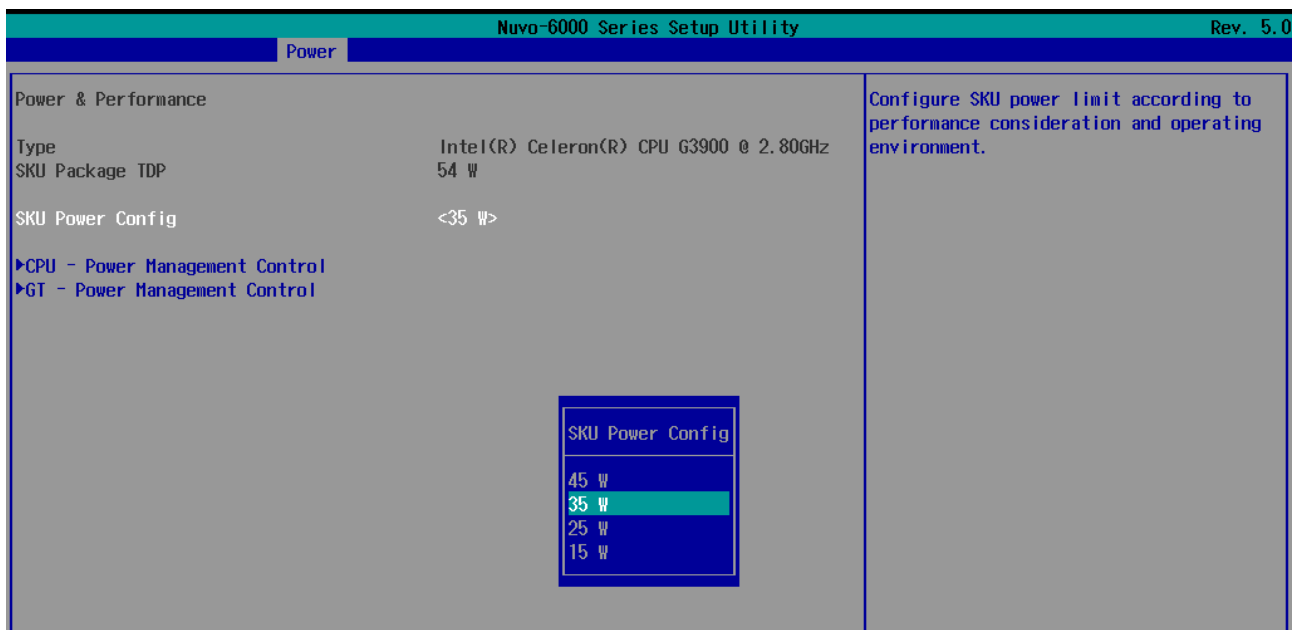

## 4.1.6 Wake-on-LAN Option

Wake-on-LAN (WOL) is a mechanism which allows you to turn on your Nuvo-6000 controller via Ethernet connection. To utilize Wake-on-LAN function, you need to enable this option first in BIOS settings. Please refer to section 3.10.2 for instructions of using WOL function.

To enable/disable "Wake on LAN" option:

1. When Nuvo-6000 controller boots up, press F2 to enter BIOS setup utility.
2. Go to **[Power]**.
3. Enable/disable the **[Wake on LAN]** option according to your application.

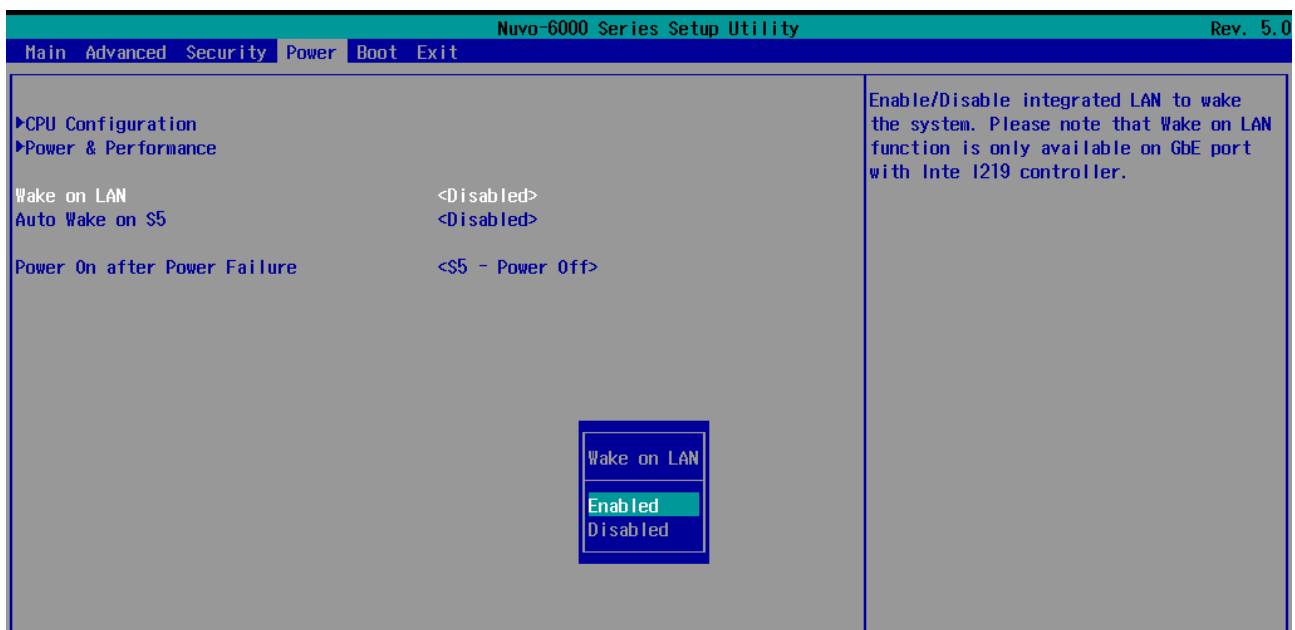

## 4.1.7 Power On after Power Failure Option

The “Power On after Power Failure” option defines the behavior of Nuvo-6000 controller when DC power is supplied.

Value	Description
S0 – Power On	System is powered on when DC power is supplied.
S5 – Power Off	System is kept in off state when DC power is supplied.

To set “Power On after Power Failure” option:

1. When Nuvo-6000 controller boots up, press F2 to enter BIOS setup utility.
2. Go to **[Power]**.
3. Set the **[Power On after Power Failure]** option to a proper value for your Nuvo-6000 controller.

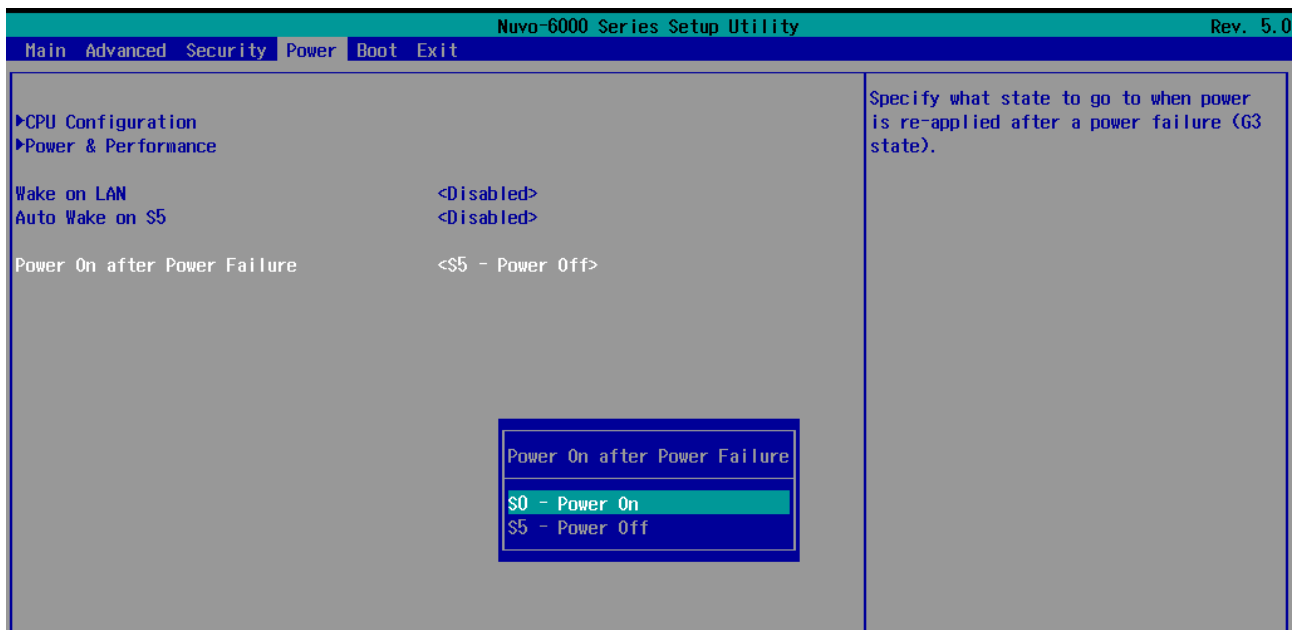



## 4.1.8 Configure Legacy/UEFI Boot Type

Nuvo-6000 series supports both legacy and UEFI boot mode. UEFI, or Unified Extensible Firmware Interface, is a specification proposed by Intel to define a software interface between operating system and platform firmware. Most modern operating systems, such as Windows 7/8/10 and Linux, support both legacy and UEFI boot mode. Compared to that legacy boot uses MBR partition for disk and VBIOS for video initialization, UEFI boot uses GPT partition which supports > 2TB partition size and GOP driver for faster video initialization.

Here is our suggestion of choosing legacy boot or UEFI boot for your system.

- If you need > 2TB disk partition, you shall choose UEFI boot mode and install operating system accordingly.
- Otherwise you can choose legacy boot mode for most cases.

To configure legacy or UEFI boot type:

1. When Nuvo-6000 controller boots up, press F2 to enter BIOS setup utility.
2. Go to **[Boot]**.
3. Set the **[Boot Type]** option to a proper value for your Nuvo-6000 controller.

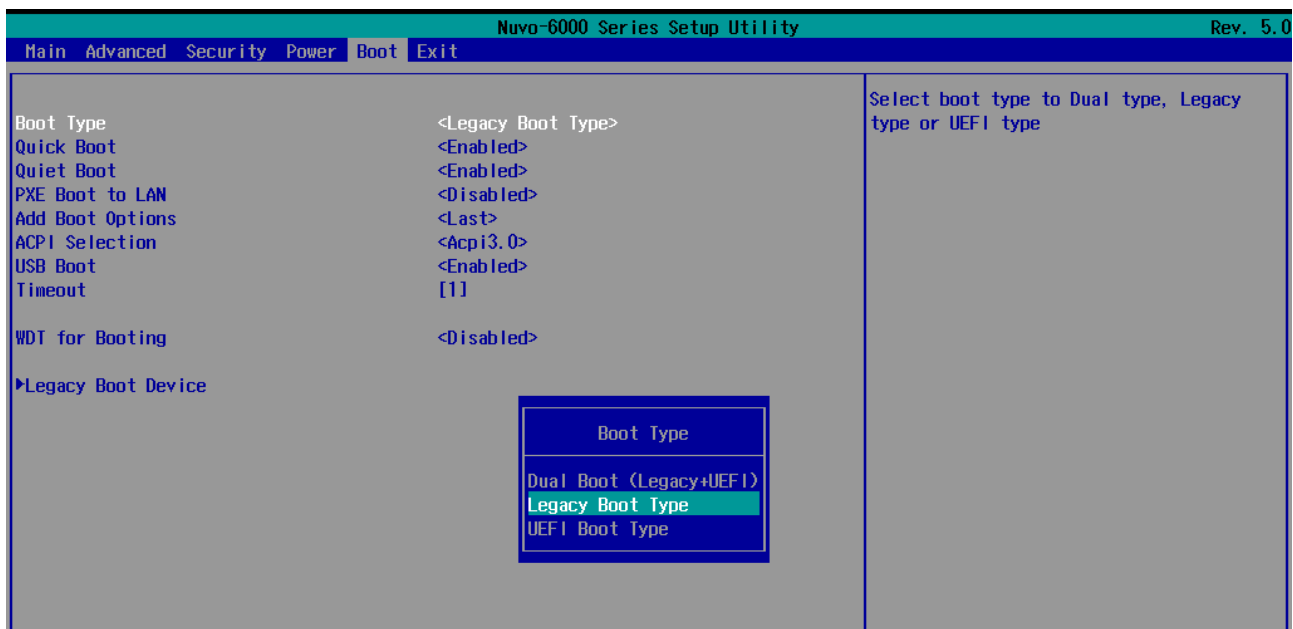

## 4.1.9 Position New Boot Device

When you plug a newly-installed boot device (e.g. USB flash disk), this option allow you determine whether to place the new boot device in the first place or the last place in the boot sequence.

1. When Nuvo-6000 controller boots up, press F2 to enter BIOS setup utility.
2. Go to **[Boot]** menu.
3. The **[Add New Boot Device]** option decides whether to place the newly-installed boot device to the **“First”** place or the **“Last”** place in the boot sequence.

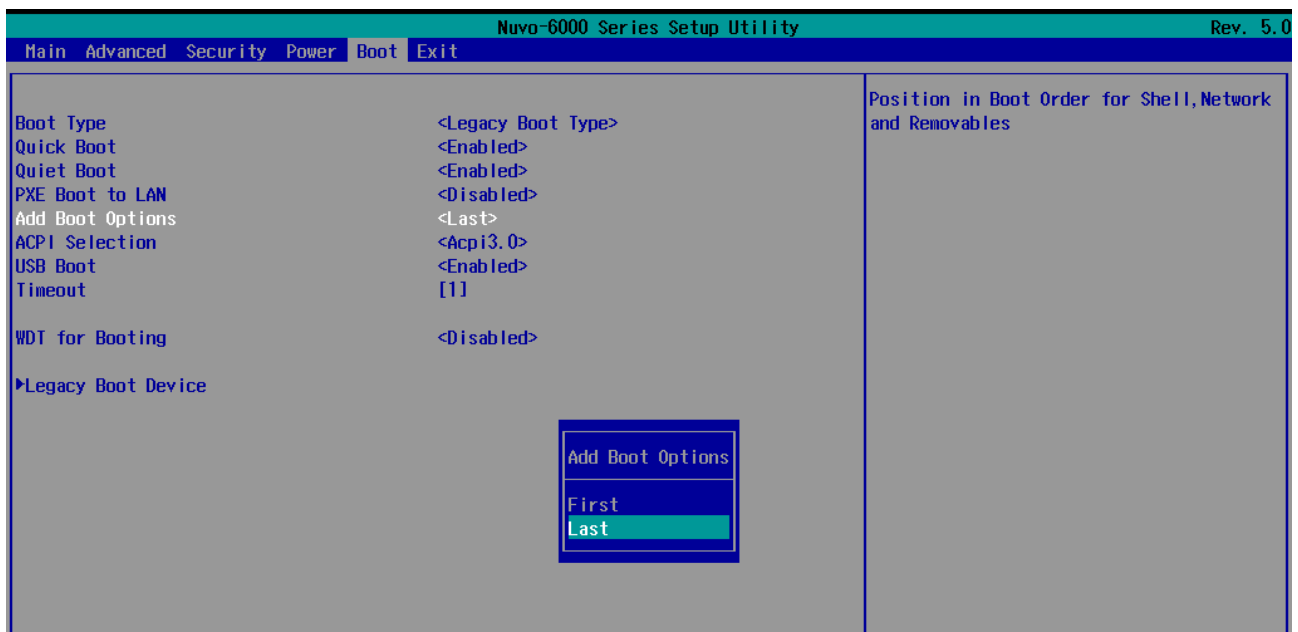

## 4.1.10 Watchdog Timer for Booting

The BIOS of Nuvo-6000 series has a useful feature which allows users to use the watchdog timer to secure the booting process. You can specify the timeout value for watchdog timer. Once the watchdog timer expires, the BIOS issues a reset command to initiate another booting process. You can also set the behavior of how to stop the watchdog timer. There are two options in BIOS menu, “**Automatically after POST**” and “**Manually after Entering OS**”. When “**Automatically after POST**” is selected, the BIOS automatically stop the watchdog timer after POST (Power-On Self Test) OK. When “**Manually after Entering OS**” is selected, it's user's liability to stop the watchdog timer when entering OS. This guarantees the system can always boot to OS, otherwise another booting process will be initiated. For information about programming watchdog timer, please refer to **Appendix B Using Watchdog Timer**.

To set the watchdog timer for boot in BIOS:

1. When Nuvo-6000 controller boots up, press F2 to enter BIOS setup utility.
2. Go to **[Boot]** menu.
3. Disable or select timeout value for **[WDT for Booting]** option.
4. Once you give a timeout value, the **[WDT Stop Option]** option appears. You can select “**Automatically after POST**” or “**Manually after Entering OS**”.

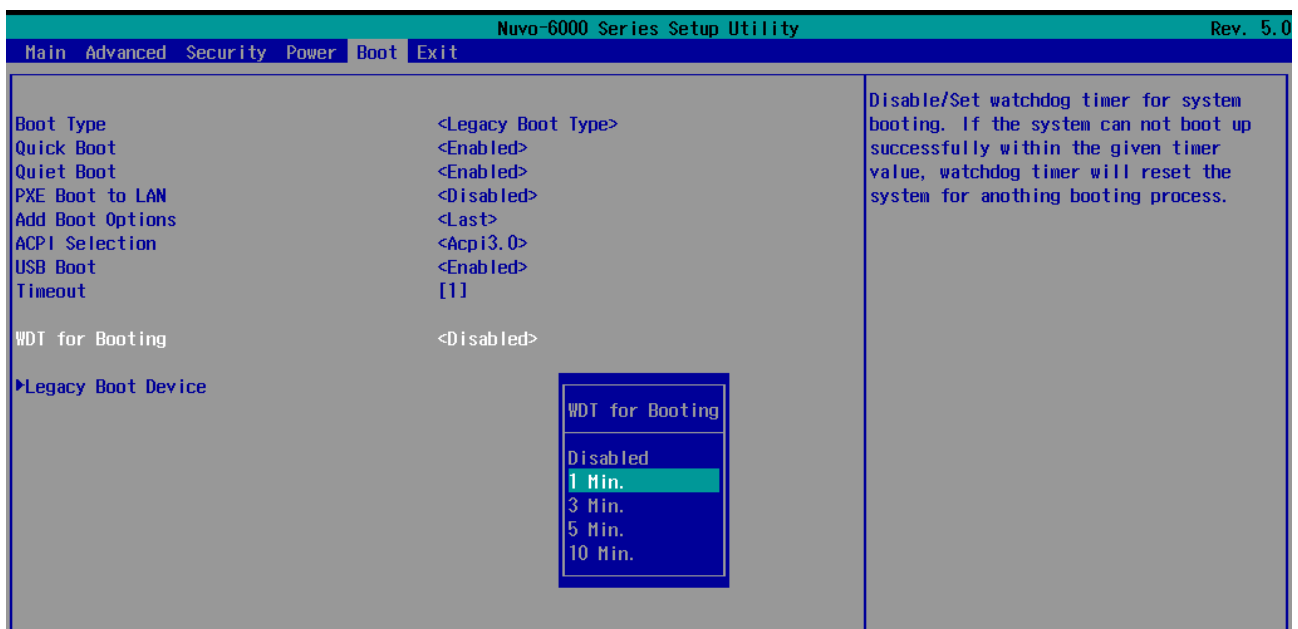

Nuvo-6000 Series Setup Utility		Rev. 5.0				
Main	Advanced	Security	Power	Boot	Exit	
Boot Type	<Legacy Boot Type>			Select when and how to to stop watchdog timer. If [Automatically after POST] is selected, watchdog timer is stopped automatically after BIOS POST. If [Manually after Entering OS] is selected, it's user's responsibility to stop watchdog timer after entering OS.		
Quick Boot	<Enabled>					
Quiet Boot	<Enabled>					
PXE Boot to LAN	<Disabled>					
Add Boot Options	<Last>					
ACPI Selection	<Acpi3.0>					
USB Boot	<Enabled>					
Timeout	[1]					
WDT for Booting	<1 Min.>					
WDT Stop Option	<Automatically after POST>					
▶Legacy Boot Device						
<div style="border: 1px solid black; padding: 5px; width: fit-content; margin: 0 auto;"> <div style="border: 1px solid black; padding: 2px; width: 100%; text-align: center;">WDT Stop Option</div> <div style="border: 1px solid black; padding: 2px; width: 100%; text-align: center;"> <span style="background-color: #00FF00; color: black;">Automatically after POST</span>                      Manually after Entering OS                 </div> </div>						



## 4.1.11 Select a Boot Device

When you have multiple bootable devices connected to your Nuvo-6000 controller (e.g. HDD, mSATA, USB flash disk, USB DVD-drive), you may need to select one of them as the boot device. There are two ways to select the device. You can either, press F12 when system boots up to go to Boot Manager and then select one of the devices, or select the boot device in BIOS settings.

To select a boot device in UEFI boot mode:

1. When Nuvo-6000 controller boots up, press F2 to enter BIOS setup utility.
2. Go to **[Boot]** → **[UEFI Boot Device]**.
3. Use F5/F6 or +/- to change the order of UEFI boot devices.

To select a boot device in legacy boot mode:

1. When Nuvo-6000 controller boots up, press F2 to enter BIOS setup utility.
2. Go to **[Boot]** → **[Legacy Boot Device]**.
3. The **[Boot Menu]** option decides whether to list all bootable devices connected to your Nuvo-6000 controller according to **[By Device]** or **[By Device Type]**. You can use F5/F6 or +/- to change the boot order of devices or device categories.

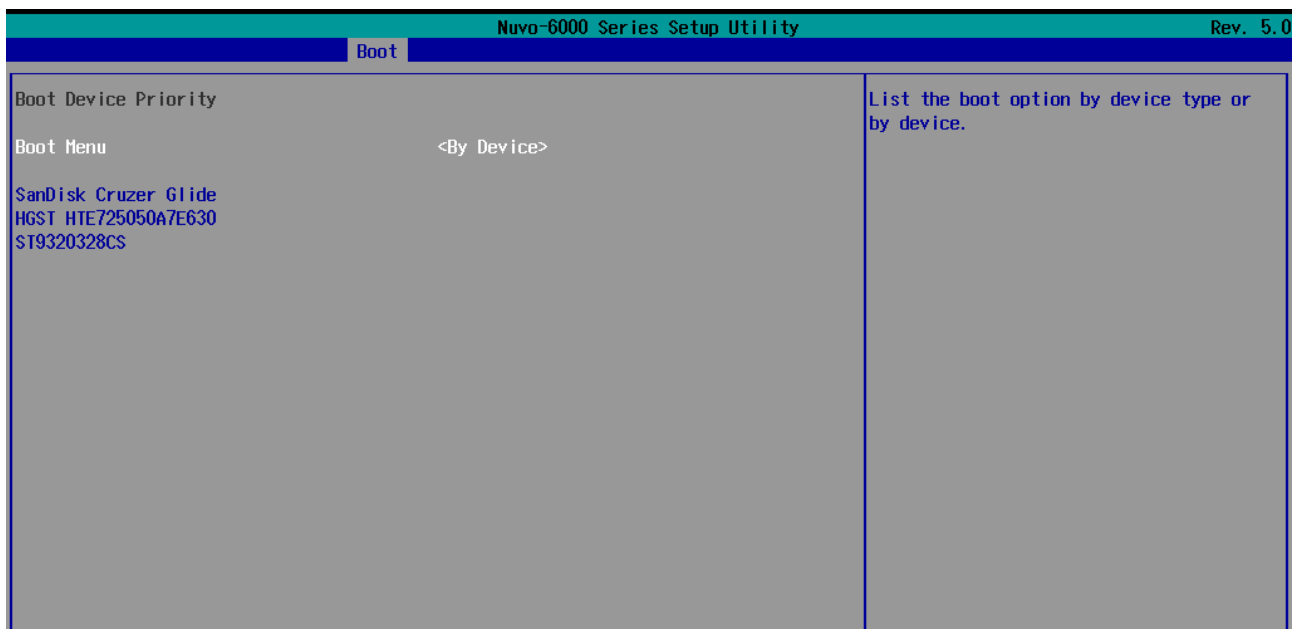

## 4.2 Operating System Support

Nuvo-6000 series supports most modern operating systems developed for Intel® x86 architecture. The following list contains the operating systems which have been tested with Nuvo-6000 series in Neosys Technology Inc.

- Microsoft Window 7 32-bit\*
- Microsoft Window 7 64-bit\*
- Microsoft Window 8.1 64-bit
- Microsoft Windows 10 64-bit
- OpenSUSE 42.1\*\*
- Fedora 23\*\*
- Ubuntu 14.04.4 LTS and 14.04.5 LTS\*\*
- Ubuntu 16.04.0 and 16.04.1 LTS\*\*
- Debian 8.3\*\*

\* *Due to the nature that XHCI driver is not included natively in Windows 7, you may encounter the issue of USB keyboard/mouse not working when installing Windows 7. Neosys offers a Windows-based batch file and step-by-step guide to help you. Please refer to Appendix A for information of installing Windows 7 on Nuvo-6000.*

\*\* *For some Linux distributions, graphics driver may not be completely implemented in its kernel. You may encounter restrictions when using these features, such as triple independent display. It should be user's liability to manually upgrade related drivers if necessary.*

Neosys will keep this list updated as we continuously test other operating systems with Nuvo-6000 series. Please contact us for the latest OS support list.





## 4.3 Driver Installation

Neosys provides a very convenient utility in “Drivers & Utilities DVD” to allow the “One-Click” driver installation. This utility automatically detects your Windows operating system and installs all necessary drivers to your Nuvo-6000 controller with just one mouse click.

### 4.3.1 Install All Drivers Using “One-Click” Driver Installation

1. Insert the “Drivers & Utilities DVD” into a USB DVD-drive attached to your Nuvo-6000 series. A setup utility launches and the following dialog appears.

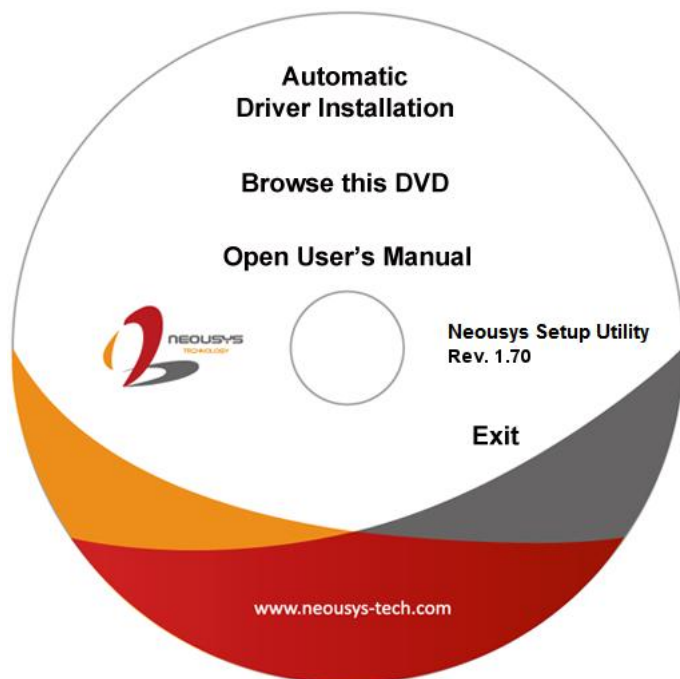

2. Click on the “**Automatic Driver Installation**”. The setup utility will automatically detect your Windows operating system and install all necessary drivers. According to different versions of Windows, the installation process takes about 6~8 minutes. Once driver installation is done, the setup utility reboots your Windows and your system works normally afterward.

## 4.3.2 Install Drivers Manually

You can also manually install each driver for Nuvo-6000 series. Please refer to the following information about installing drivers for different operating system.

### Windows 7 32-bit

The recommended driver installation sequence is

1. Chipset driver (x:\Driver\_Pool\Chipset\_10\_Series\Win\_ALL\SetupChipset.exe)
2. Graphics driver (x:\Driver\_Pool\Graphics\_6th\_i7\Win\_7\_32\Setup.exe)
3. Audio driver (x:\Driver\_Pool\Audio\_ALC262\Win\_ALL\_32\Setup.exe)
4. LAN driver  
(x:\Driver\_Pool\GbE\_I210\_I350\Win\_ALL\_32\APPS\PROSETDX\Win32\DxSetup.exe)
5. ME driver (x:\Driver\_Pool\ME\_10\_Series\Win\_ALL\_AMT\SetupME.exe)

### Windows 7 64-bit

The recommended driver installation sequence is

1. Chipset driver (x:\Driver\_Pool\Chipset\_10\_Series\Win\_ALL\SetupChipset.exe)
2. Graphics driver (x:\Driver\_Pool\Graphics\_6th\_i7\Win\_7\_8\_10\_64\Setup.exe)
3. Audio driver (x:\Driver\_Pool\Audio\_ALC262\Win\_ALL\_64\Setup.exe)
4. LAN driver  
(x:\Driver\_Pool\GbE\_I210\_I350\Win\_ALL\_64\APPS\PROSETDX\Winx64\DxSetup.exe)
5. TPM 2.0 driver (x:\Driver\_Pool\TPM2\Win7\_64\Windows6.1-KB2920188-v7-x64.msu)
6. ME driver (x:\Driver\_Pool\ME\_10\_Series\Win\_ALL\_AMT\SetupME.exe)

### Windows 8/8.1 64-bit

The recommended driver installation sequence is

1. Chipset driver (x:\Driver\_Pool\Chipset\_10\_Series\Win\_ALL\SetupChipset.exe)
2. Graphics driver (x:\Driver\_Pool\Graphics\_6th\_i7\Win\_7\_8\_10\_64\Setup.exe)
3. Audio driver (x:\Driver\_Pool\Audio\_ALC262\Win\_ALL\_64\Setup.exe)
4. LAN driver  
(x:\Driver\_Pool\GbE\_I210\_I350\Win\_ALL\_64\APPS\PROSETDX\Winx64\DxSetup.exe)
5. ME driver (x:\Driver\_Pool\ME\_10\_Series\Win\_ALL\_AMT\SetupME.exe)

### Windows 10 64-bit

The recommended driver installation sequence is

1. Chipset driver (x:\Driver\_Pool\Chipset\_10\_Series\Win\_ALL\SetupChipset.exe)
2. Graphics driver (x:\Driver\_Pool\Graphics\_6th\_i7\Win\_7\_8\_10\_64\Setup.exe)
3. Audio driver (x:\Driver\_Pool\Audio\_ALC262\Win\_ALL\_64\Setup.exe)



4. LAN driver  
(x:\Driver\_Pool\GbE\_I210\_I350\Win\_ALL\_64\APPS\PROSETDX\Winx64\DxSetup.exe)
5. ME driver (x:\Driver\_Pool\ME\_10\_Series\Win\_ALL\_AMT\SetupME.exe)



### 4.3.3 Install Driver for WDT Function

Neosys provides a driver package which contain function APIs for WDT function. You should install the driver package (WDT\_DIO\_Setup.exe) in prior to use these functions. Please note that you must install WDT\_DIO\_Setup\_v2.2.4 or later revision for Nuvo-6000 series.

#### **Windows 7 32-bit**

Please execute the driver setup program in the following directory.

x:\Driver\_Pool\WDT\_DIO\XP\_Win7\_8\_32\WDT\_DIO\_Setup\_v2.2.4.exe

#### **Windows 7/8/10 64-bit (x64)**

Please execute the driver setup program in the following directory.

x:\Driver\_Pool\WDT\_DIO\Win7\_8\_64\WDT\_DIO\_Setup\_v2.2.4(x64).exe

#### **Windows 7/8/10 64-bit (WOW64)**

Please execute the driver setup program in the following directory.

x:\Driver\_Pool\WDT\_DIO\Win7\_8\_WOW64\WDT\_DIO\_Setup\_v2.2.4(wow64).exe



# Appendix A Install Windows 7 on Nuvo-6000

Intel Skylake platform removes EHCI controller and supports USB 2.0 and USB 3.0 connectivity only through its xHCI controller. For Windows 8/8.1 and Windows10, no issue is anticipated due to native xHCI support in the OS. However, Windows 7 does not natively support xHCI thus manual installation of Intel's xHCI driver is required to support both USB storage device and USB keyboard/mouse during the OS installation process.

To install Windows 7 on Nuvo-6000, the simplest way is to create a USB thumb drive with Windows 7 installation files and Intel xHCI driver included. Neousys provides a Windows-based batch file and step-by-step guide to help you. Please follow instructions in this section to install Windows 7 on your Nuvo-6000.

## A.1 Before We Start ...

Before we proceed with the creation of USB flash drive installer, please make sure you have the following items.

1. Windows 7 original installation DVD
2. USB thumb drive with at least 4 GB capacity
3. Software utility to create ISO image from DVD, e.g.
  - ImgBurn (<http://www.imgburn.com>)
  - Nero (<http://www.nero.com>)
4. Software utility to create bootable USB drive from ISO file, e.g.
  - Microsoft Windows USB/DVD Download Tool (<https://www.microsoft.com/en-us/download/windows-usb-dvd-download-tool>)
  - ISO to USB (<http://www.isotousb.com>)
5. You should have at least 10 GB disk space on your local drive.

## A.2 Create USB Flash Drive Installer Step-by-Step

### Step 1 - Create .ISO file from Windows 7 DVD

The first step is to create a .iso file from the Windows 7 DVD. Here we use ImgBurn (<http://www.imgburn.com>) to create the .iso file and save it to local drive.



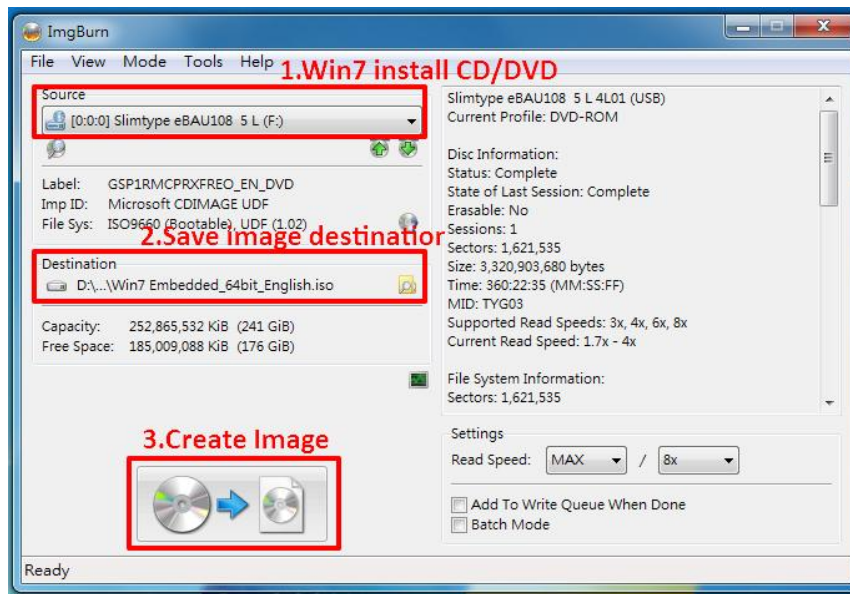

## Step 2 - Create USB flash drive installer from .ISO

The next step is to create a bootable USB flash drive using the .iso file created in step 1. Here we use Microsoft Windows USB/DVD Download Tool to create the USB flash drive (<https://www.microsoft.com/en-us/download/windows-usb-dvd-download-tool>). Please note that the content of USB flash drive will be destroyed.

1. Right-click on the '**Windows 7 USB DVD Download Tool**' and select '**Run as administrator**'.
2. Follow the instructions below to create the USB flash drive installer.

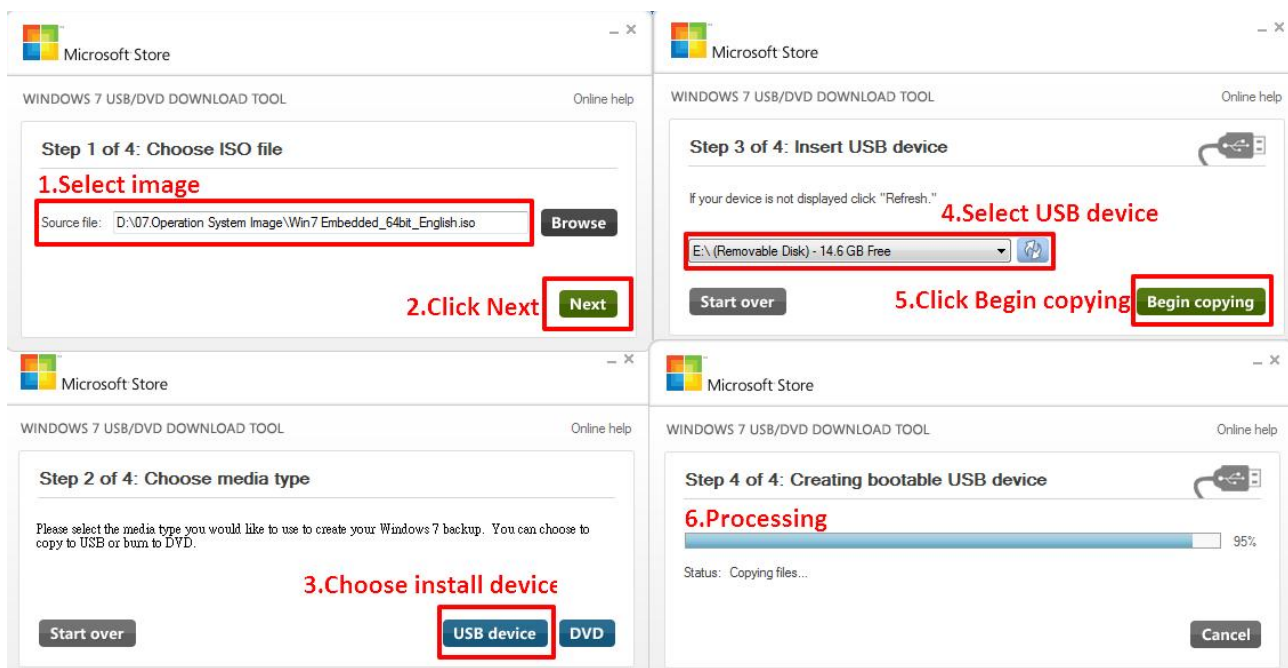



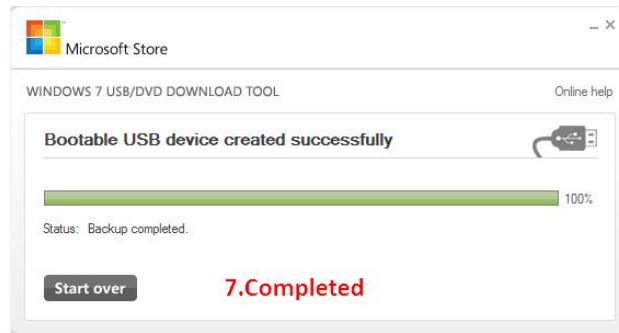

## Step 3 - Create working folder on your local drive

In this step, we need to create a working folder on your local drive and copy necessary files to it. Please following the steps below.

1. Create a temporary working folder on your local drive. Here we use D:\WIM as an example.
2. Create another folder under D:\WIM for Intel xHCI driver files. Here we use \x86 for Win7 32-bit and \x64 for Win7 64-bit.
3. Copy xHCI driver files to the corresponding folder. You can find the driver files from Neousys Driver DVD.
  - For Win7 32-bit, copy all files from x:\Driver\_Pool\USB3\_10\_Series\Win7\_ALL\x86 to D:\WIM\x86
  - For Win7 64-bit, copy all files from x:\Driver\_Pool\USB3\_10\_Series\Win7\_ALL\x64 to D:\WIM\x64
 (where x: denotes the drive of your DVD drive)
4. Copy **install.wim** and **boot.wim** from \sources folder of your USB flash drive to D:\WIM.

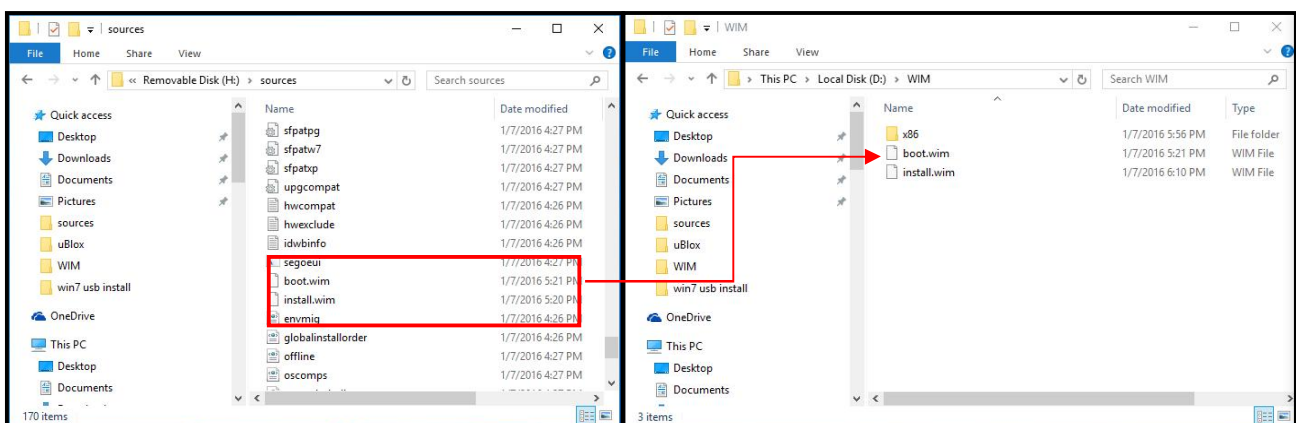

5. Copy the batch file (**Win7\_USB3\_Patch\_x86.bat** or **Win7\_USB3\_Patch\_x64.bat**) to D:\WIM. You can find the batch file in x:\Driver\_Pool\USB3\_10\_Series\Win7\_ALL.



## Step 4 - Execute batch file to patch .wim files

To support xHCI for Windows 7 installation, both install.wim and boot.wim need to be patched to include xHCI driver files. Neosys offers Windows-based batch files (**Win7\_USB3\_Patch\_x86.bat** for Windows 7 32-bit and **Win7\_USB3\_Patch\_x64.bat** for Windows 7 64-bit) to simplify this process.

1. Before executing the batch file, please make sure folders specified in the batch file are identical to your working folders.

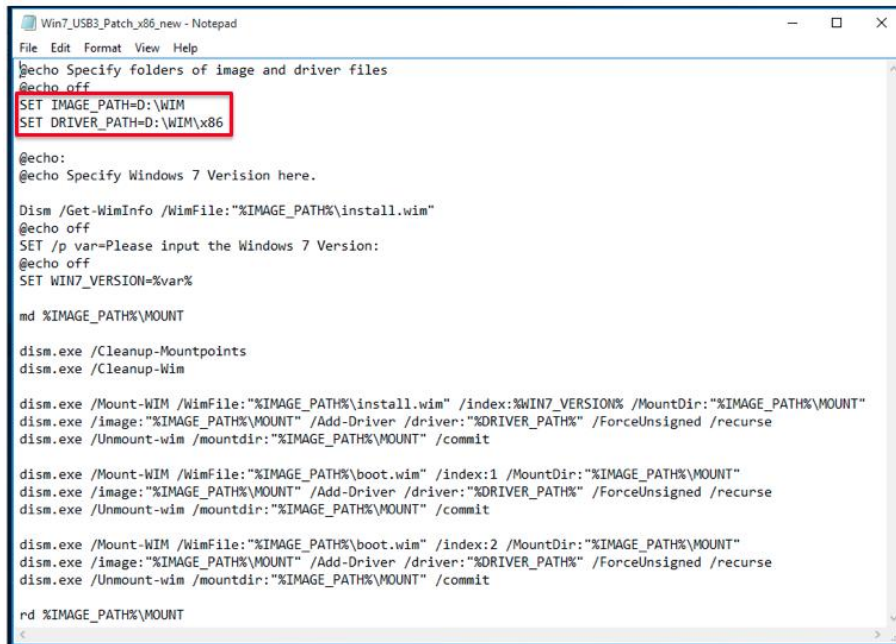

```

Win7_USB3_Patch_x86_new - Notepad
File Edit Format View Help
@echo Specify folders of image and driver files
@echo off
SET IMAGE_PATH=D:\WIM
SET DRIVER_PATH=D:\WIM\x86

@echo:
@echo Specify Windows 7 Verision here.

Dism /Get-WimInfo /WimFile:"%IMAGE_PATH%\install.wim"
@echo off
SET /p var=Please input the Windows 7 Version:
@echo off
SET WIN7_VERSION=%var%

md %IMAGE_PATH%\MOUNT

dism.exe /Cleanup-Mountpoints
dism.exe /Cleanup-Wim

dism.exe /Mount-WIM /WimFile:"%IMAGE_PATH%\install.wim" /index:%WIN7_VERSION% /MountDir:"%IMAGE_PATH%\MOUNT"
dism.exe /image:"%IMAGE_PATH%\MOUNT" /Add-Driver /driver:"%DRIVER_PATH%" /ForceUnsigned /recurse
dism.exe /Unmount-wim /mountdir:"%IMAGE_PATH%\MOUNT" /commit

dism.exe /Mount-WIM /WimFile:"%IMAGE_PATH%\boot.wim" /index:1 /MountDir:"%IMAGE_PATH%\MOUNT"
dism.exe /image:"%IMAGE_PATH%\MOUNT" /Add-Driver /driver:"%DRIVER_PATH%" /ForceUnsigned /recurse
dism.exe /Unmount-wim /mountdir:"%IMAGE_PATH%\MOUNT" /commit

dism.exe /Mount-WIM /WimFile:"%IMAGE_PATH%\boot.wim" /index:2 /MountDir:"%IMAGE_PATH%\MOUNT"
dism.exe /image:"%IMAGE_PATH%\MOUNT" /Add-Driver /driver:"%DRIVER_PATH%" /ForceUnsigned /recurse
dism.exe /Unmount-wim /mountdir:"%IMAGE_PATH%\MOUNT" /commit

rd %IMAGE_PATH%\MOUNT
  
```

2. Execute the batch file with administrator privilege. It appears an interactive menu for choosing Windows 7 edition. Please input the corresponding index number for your Windows 7 edition and press Enter.

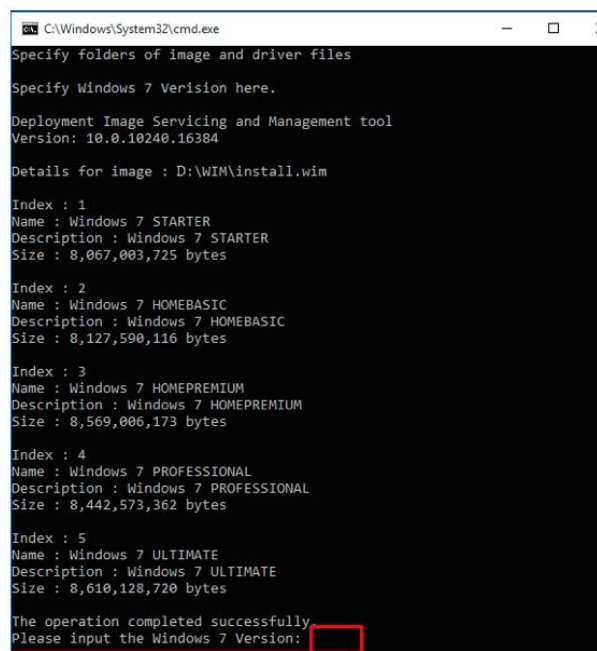

```

C:\Windows\System32\cmd.exe
Specify folders of image and driver files

Specify Windows 7 Verision here.

Deployment Image Servicing and Management tool
Version: 10.0.10240.16384

Details for image : D:\WIM\install.wim

Index : 1
Name : Windows 7 STARTER
Description : Windows 7 STARTER
Size : 8,067,003,725 bytes

Index : 2
Name : Windows 7 HOMEBASIC
Description : Windows 7 HOMEBASIC
Size : 8,127,590,116 bytes

Index : 3
Name : Windows 7 HOMEPREMIUM
Description : Windows 7 HOMEPREMIUM
Size : 8,569,006,173 bytes

Index : 4
Name : Windows 7 PROFESSIONAL
Description : Windows 7 PROFESSIONAL
Size : 8,442,573,362 bytes

Index : 5
Name : Windows 7 ULTIMATE
Description : Windows 7 ULTIMATE
Size : 8,610,128,720 bytes

The operation completed successfully
Please input the Windows 7 Version:
  
```



3. The batch file will automatically patch both install.wim and boot.wim. It takes few minutes to finish the patch process.
4. Once patch finished, please overwrite the \sources\install.wim and \sources\boot.wim in USB flash drive installer with the patched ones.

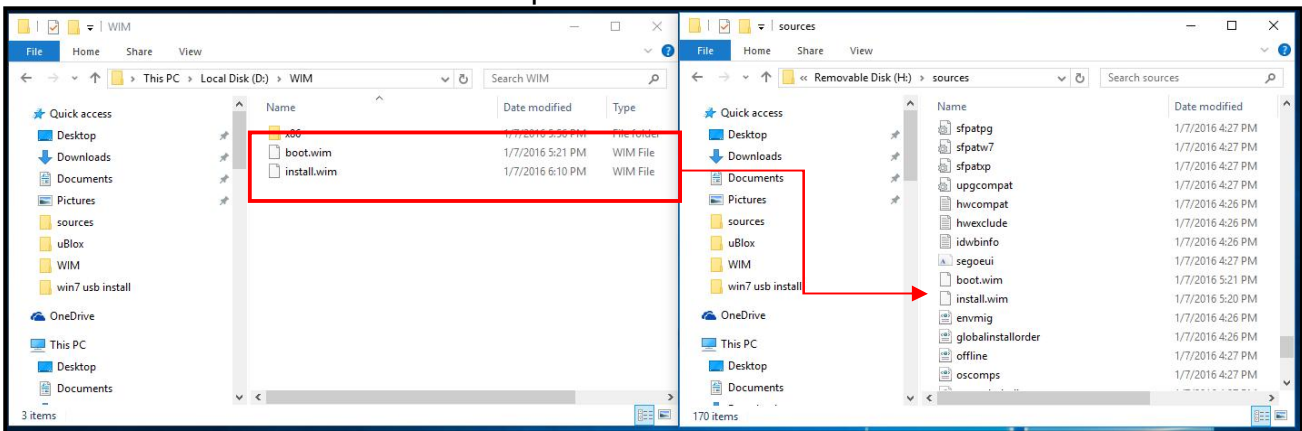

## Step 5 - Install Windows 7 using USB flash drive installer

Now you can use the USB flash drive to install Windows 7 on your Nuvo-6000.

1. Plug the USB flash drive to USB port of Nuvo-6000.
2. Power on the system and press F12 to select USB flash drive as boot device.
3. Follow regular installation process to install Windows 7 on your Nuvo-6000. The xHCI driver is included in the newly-installed system.

### Note:

If it appears a warning message of “Setup was unable to create a new system partition or locate an existing system partition”, please to unplug and re-plug the USB flash drive, click ‘Refresh’ and try again.

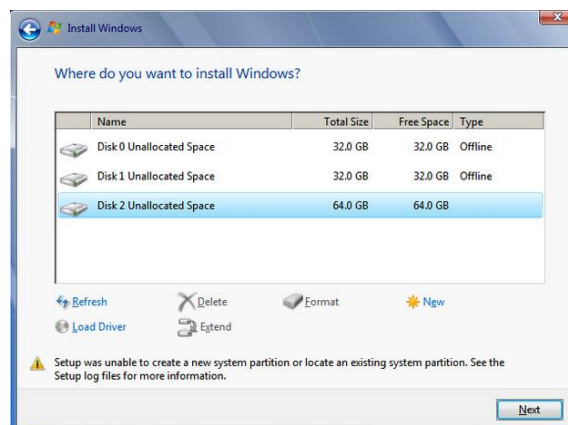

# Appendix B Using Watchdog Timer

Nuvo-6000 series provides watchdog timer (WDT) function to ensure reliable system operation. The WDT is a hardware mechanism to reset the system if the watchdog timer is expired. Users can start the WDT and keeping resetting the timer to make sure the system or program is running. Otherwise, the system shall be reset.

In this section, we'll illustrate how to use the function library provided by Neosys to program the WDT functions. Currently, WDT driver library supports Windows 7/8.1/10 32-bit and 64-bit versions. For other OS support, please contact Neosys Technology for further information.

## Install WDT\_DIO Library

The WDT\_DIO function library is delivered in the form of a setup package named **WDT\_DIO\_Setup.exe**. In prior to program WDT, you should execute the setup program and install the WDT library. Please use the following WDT\_DIO\_Setup packages according to your operating systems and applications on Nuvo-6000 series.

- For Windows 7/8.1/10 32-bit OS, please install WDT\_DIO\_Setup\_v2.2.4.exe or later version.
- For Windows 7/8.1/10 64-bit OS with 64-bit application (x64 mode), please install WDT\_DIO\_Setup\_v2.2.4(x64).exe or later version.
- For Windows 7/8.1/10 64-bit OS with 32-bit application (WOW64 mode), please install WDT\_DIO\_Setup\_v2.2.4(wow64).exe or later version.



To install WDT\_DIO\_Setup package, please follow steps described below.

1. Execute **WDT\_DIO\_Setup.2.2.4.exe**. The following dialog appears.

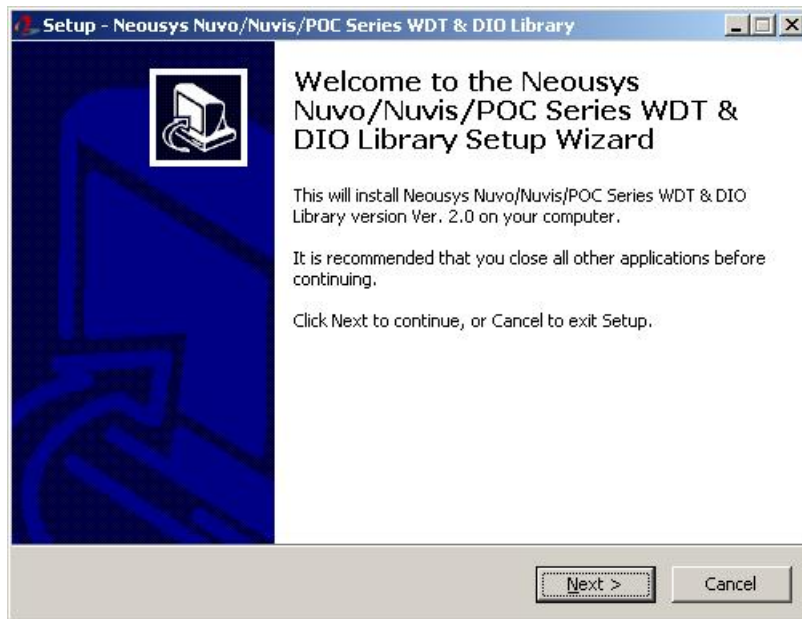

2. Click "Next >" and specify the directory of installing related files. The default directory is **C:\Neosys\WDT\_DIO**.

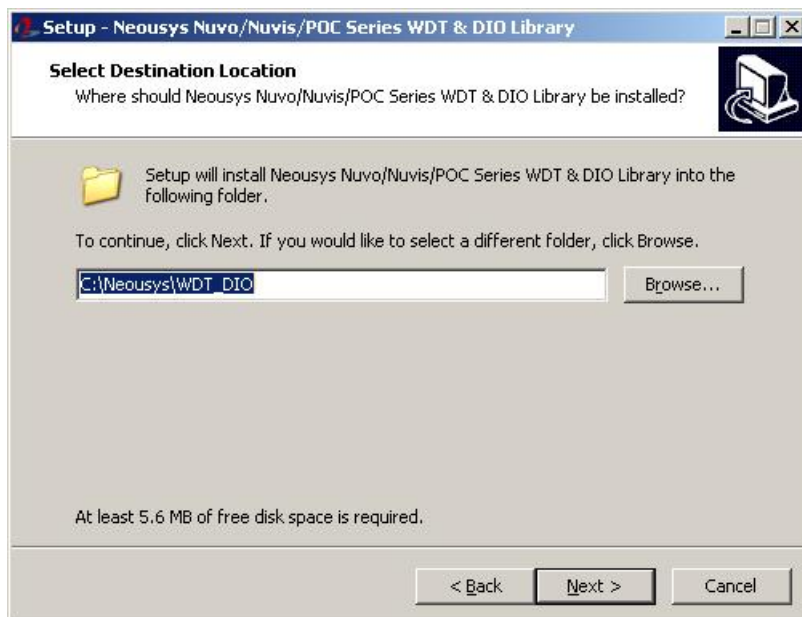

- Once the installation is finished, a dialog appears to prompt you to reboot the system. The WDT & DIO library will take effect after system rebooting.

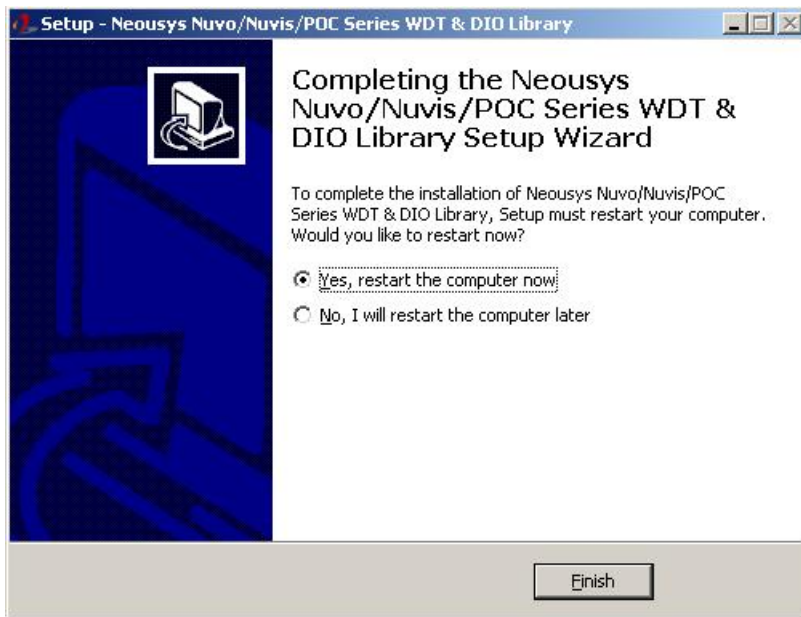

- When you programming your WDT or DIO program, the related files are located in
  - Header file: \Include
  - Lib file: \Lib
  - Function Reference: \Manual
  - Sample Code: \Sample\WDT\_Demo (Demo for Watchdog Timer)

# WDT Function Reference

## InitWDT

### Syntax

```
BOOL InitWDT(void);
```

### Description

Initialize the WDT function. You should always invoke InitWDT() before set or start watchdog timer.

### Parameter

None

### Return Value

Returns TRUE if initialization successes, FALSE if initialization failed.

### Usage

```
BOOL bRet = InitWDT();
```

## SetWDT

### Syntax

```
BOOL SetWDT(WORD tick, BYTE unit);
```

### Description

Set timeout value and unit for watchdog timer. When InitWDT() is invoked, a default timeout value of 255 seconds is assigned.

### Parameter

*tick*

WORD value (1 ~ 65535) to indicate timeout ticks.

*unit*

BYTE value (0 or 1) to indicate unit of timeout ticks.

0 : unit is minute

1: unit is second

### Return Value

If value of unit is correct (0 or 1), this function returns TRUE, otherwise FALSE.

### Usage

```
WORD tick=255;
```

```
BYTE unit=1; //unit is second.
```

```
BOOL bRet = SetWDT(tick, unit); //timeout value is 255 seconds
```





## StartWDT

### Syntax

```
BOOL StartWDT(void);
```

### Description

Start countdown of WDT. When WDT is started, the WDT LED indicator starts to blink in a frequency of 1Hz. If no ResetWDT() or StopWDT is invoked before WDT is counted to 0, the WDT expires and system resets.

### Parameter

None

### Return Value

If the timeout value is given in correct format, this function returns TRUE, otherwise FALSE.

### Usage

```
BOOL bRet = StartWDT();
```

## ResetWDT

### Syntax

```
BOOL ResetWDT(void);
```

### Description

Reset the timeout value to the value given by SetWDT(). If no ResetWDT() or StopWDT is invoked before WDT is counted to 0, the WDT expires and system resets.

### Parameter

None

### Return Value

Always returns TRUE;

### Usage

```
BOOL bRet = ResetWDT();
```

## StopWDT

### Syntax

```
BOOL StopWDT(void);
```

### Description

Stop the countdown of WDT. When WDT is stopped, the WDT LED indicator stops blinking.

### Parameter

None

### Return Value



Always returns TRUE;

**Usage**

BOOL bRet = StopWDT()

