

# PXIe-3987/3977/3937

PXI Express Embedded Controller

## User's Manual



**Manual Rev.:** 1.1

**Revision Date:** December 24, 2019

**Part No:** 50-17056-1010

# Revision History

Revision	Release Date	Description of Change(s)
1.00	2019-10-22	Initial release
1.1	2019-12-24	Add support for Intel® Core™ i5-7440EQ/i3-7100E processors; update BIOS and driver sections

# Preface

## Copyright © 2019 ADLINK Technology Inc.

This document contains proprietary information protected by copyright. All rights are reserved. No part of this manual may be reproduced by any mechanical, electronic, or other means in any form without prior written permission of the manufacturer.

## Disclaimer

The information in this document is subject to change without prior notice in order to improve reliability, design, and function and does not represent a commitment on the part of the manufacturer.

In no event will the manufacturer be liable for direct, indirect, special, incidental, or consequential damages arising out of the use or inability to use the product or documentation, even if advised of the possibility of such damages.

ADLINK is committed to fulfill its social responsibility to global environmental preservation through compliance with the European Union's Restriction of Hazardous Substances (RoHS) directive and Waste Electrical and Electronic Equipment (WEEE) directive. Environmental protection is a top priority for ADLINK. We have enforced measures to ensure that our products, manufacturing processes, components, and raw materials have as little impact on the environment as possible. When products are at their end of life, our customers are encouraged to dispose of them in accordance with the product disposal and/or recovery programs prescribed by their nation or company.



## Battery Labels (for products with battery)



**Li-ion**

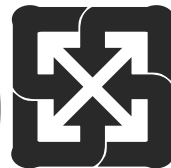

廢電池請回收

## California Proposition 65 Warning



**WARNING:** This product can expose you to chemicals including acrylamide, arsenic, benzene, cadmium, Tris(1,3-dichloro-2-propyl)phosphate (TDCPP), 1,4-Dioxane, formaldehyde, lead, DEHP, styrene, DINP, BBP, PVC, and vinyl materials, which are known to the State of California to cause cancer, and acrylamide, benzene, cadmium, lead, mercury, phthalates, toluene, DEHP, DIDP, DnHP, DBP, BBP, PVC, and vinyl materials, which are known to the State of California to cause birth defects or other reproductive harm. For more information go to [www.P65Warnings.ca.gov](http://www.P65Warnings.ca.gov).

## Trademarks

Product names mentioned herein are used for identification purposes only and may be trademarks and/or registered trademarks of their respective companies.

## Conventions

Take note of the following conventions used throughout this manual to make sure that users perform certain tasks and instructions properly.



NOTE:

Additional information, aids, and tips that help users perform tasks.

---



CAUTION:

Information to prevent **minor** physical injury, component damage, data loss, and/or program corruption when trying to complete a task.

---



WARNING:

Information to prevent **serious** physical injury, component damage, data loss, and/or program corruption when trying to complete a specific task.

---

# Table of Contents

<b>Revision History</b> .....	<b>ii</b>
<b>Preface</b> .....	<b>iii</b>
<b>Table of Contents</b> .....	<b>v</b>
<b>List of Figures</b> .....	<b>ix</b>
<b>List of Tables</b> .....	<b>xi</b>
<b>1 Introduction</b> .....	<b>1</b>
1.1 Features.....	2
1.2 Specifications.....	3
1.3 I/O and Indicators .....	7
1.3.1 Front Panel .....	7
1.3.2 GPIB Connector .....	10
1.3.3 Reset Button.....	11
1.3.4 LED Indicators .....	11
1.3.5 USB 2.0 Ports.....	12
1.3.6 Gigabit Ethernet Ports .....	13
1.3.7 USB 3.0 Ports.....	14
1.3.8 COM Port.....	14
1.3.9 Onboard Connections and Settings.....	15
<b>2 Getting Started</b> .....	<b>17</b>
2.1 Package Contents .....	17
2.2 Operating System Installation.....	18
2.2.1 Installation Environment .....	19
2.2.2 Installing the PXIe-3987/3977/3937 .....	20
2.2.3 Replacing the Hard Drive or Solid State Drive .....	23
2.2.4 Replacing the Battery Backup .....	24

2.2.5	Clearing CMOS.....	25
<b>3</b>	<b>Driver Installation.....</b>	<b>27</b>
<b>A</b>	<b>Appendix: PXI Trigger I/O Functions .....</b>	<b>29</b>
A.1	Data Types.....	29
A.2	Function Library .....	31
A.2.1	TRIG_Init .....	31
A.2.2	TRIG_Close .....	31
A.2.3	TRIG_SetSoftTrg.....	32
A.2.4	TRIG_Trigger_Route .....	33
A.2.5	TRIG_Trigger_Clear .....	35
A.2.6	TRIG_GetSoftTrg.....	35
A.2.7	TRIG_Trigger_Route_Query .....	36
A.2.8	TRIG_GetDriverRevision .....	38
<b>B</b>	<b>Appendix: BIOS Setup.....</b>	<b>39</b>
B.1	Entering the BIOS .....	39
B.2	Navigation .....	40
B.3	Menu Structure .....	41
B.4	Main .....	42
B.4.1	BIOS Information .....	42
B.4.2	Processor Information.....	42
B.4.3	PCH Information .....	43
B.4.4	System Management.....	43
B.4.5	System Date and Time .....	46
B.5	Advanced .....	47
B.5.1	CPU Configuration.....	47
B.5.2	Memory Configuration .....	49
B.5.3	Graphics Configuration.....	49
B.5.4	USB Configuration .....	50
B.5.5	TPM 2.0 Configuration.....	51
B.5.6	Onboard Devices Configuration.....	52

B.5.7	PCI and PCIe Configuration .....	53
B.5.8	Advanced Power Management .....	53
B.5.9	Network Stack Configuration .....	54
B.5.10	Hardware Health Configuration .....	54
B.5.11	PXIe Links Control Configuration .....	54
B.6	Security.....	55
B.6.1	Secure Boot.....	55
B.7	Boot .....	56
B.7.1	CSM.....	57
B.7.2	UEFI Hard Disk Drive BBS Priorities .....	57
B.8	Save & Exit .....	58
<b>C</b>	<b>Appendix: Dual BIOS .....</b>	<b>59</b>
<b>D</b>	<b>Appendix: Legacy Boot Mode Settings.....</b>	<b>61</b>
	<b>Important Safety Instructions .....</b>	<b>63</b>
	<b>Getting Service.....</b>	<b>65</b>

This page intentionally left blank.



## List of Figures

Figure 1-1: Functional Block Diagram.....	3
Figure 1-2: Front Panel .....	7
Figure 1-3: PXI Trigger SMB Jack .....	8
Figure 1-4: DisplayPort Connector.....	9
Figure 1-5: GPIB Connector.....	10
Figure 1-6: LED Indicators .....	11
Figure 1-7: COM Port.....	14
Figure 1-8: Onboard Configuration .....	15
Figure B-1: BIOS Setup Navigation.....	40

This page intentionally left blank.

## List of Tables

Table 1-1: Front Panel Legend .....	7
Table 1-2: DisplayPort Pin Assignment .....	9
Table 1-3: GPIB Pin Description .....	10
Table 1-4: LED Indicator Legend .....	11
Table 1-5: USB 2.0 Port Pin Assignment.....	12
Table 1-6: Ethernet Port Pin Assignments.....	13
Table 1-7: Ethernet Status LED Descriptions .....	13
Table 1-8: D-sub COM Port Signal Functions.....	14
Table 1-9: Onboard Configuration Legend .....	15
Table B-1: BIOS Hot Key Functions.....	40

This page intentionally left blank.

# 1 Introduction

The ADLINK PXIe-3987/3977/3937 PXI Express embedded controller is based on the seventh generation Intel® Core™ processor specifically designed for PXI Express-based testing systems. A rugged and stable operating environment is provided for a variety of testing and measurement applications.

Combining state-of-the-art Intel® Core™ processors and up to 32GB of DDR4 2400MHz memory, the PXIe-3987/3977/3937 utilizes multiple computing engines on a single processor, enabling execution of four independent tasks simultaneously. With a configurable PCIe switch, the PXIe-3987/3977/3937 can support four links x4 or two links x8 x16 PXI Express link capability, with maximum system throughput of up to 16 GB/s (PCI Express 3.0).

PXI Express-based testing systems typically make up a PXI Express platform and diversified standalone instruments for complex testing tasks. The PXIe-3987/3977/3937 series provides ample interfaces, including two DisplayPort connectors, allowing connection to two monitors, dual USB 3.0 connections for high speed peripheral devices, dual Gigabit Ethernet ports, one for LAN connection and the other for controlling LXI instruments, four USB 2.0 ports for peripheral devices and USB instrument control, an SMB connector for configurable input/output routing of signal to/from PXI Trigger Bus on PXI Express chassis, and a Micro-D GPIB connector for GPIB instrument connection, for hybrid PXI-based testing system control.



NOTE:

Memory addressing over 4 GB is OS-dependent, such that a 32-bit operating system may be unable to address memory space over 4GB. To fully utilize memory, 64-bit operating systems are required.

---

## 1.1 Features

- ▶ PXI-5 PXI Express Hardware Specification Rev.1.0
- ▶ 7th Generation Intel® Core™ processors
  - ▷ **PXIe-3987**: Intel® Core™ i7-7820EQ 3.0/3.7 GHz (Turbo), 45W/35W (cTDP, 4C/GT2)
  - ▷ **PXIe-3977**: Intel® Core™ i5-7440EQ 2.9/3.6 GHz (Turbo), 45W/35W (cTDP, 4C/GT2)
  - ▷ **PXIe-3937**: Intel® Core™ i3-7100E 2.9 GHz, 35W (2C/GT2)
- ▶ Dual Channel DDR4 SO-DIMM
  - ▷ Up to 32 GB 2400 MHz
- ▶ Maximum System Throughput 16 GB/s
- ▶ PXI Express Link Capability
  - ▷ 4-link Configuration: x4 x4 x4 x4
  - ▷ 2-link Configuration: x16 x8
- ▶ Preinstalled 240 GB SATA SSD
  - ▷ Supports 2.5" HDD or SSD
  - ▷ SATA 6.0 Gb/s
  - ▷ Supports AHCI
- ▶ Integrated I/O
  - ▷ Dual Gigabit Ethernet ports
  - ▷ Two USB 3.0 Ports
  - ▷ Four USB 2.0 Ports
  - ▷ Built-in GPIB (IEEE488) controller
  - ▷ Dual DisplayPort connectors
  - ▷ One COM port (D-sub9 serial)
  - ▷ Trigger I/O for advanced PXI™ trigger functions
- ▶ OS
  - ▷ Microsoft Windows 10 64-bit

## 1.2 Specifications

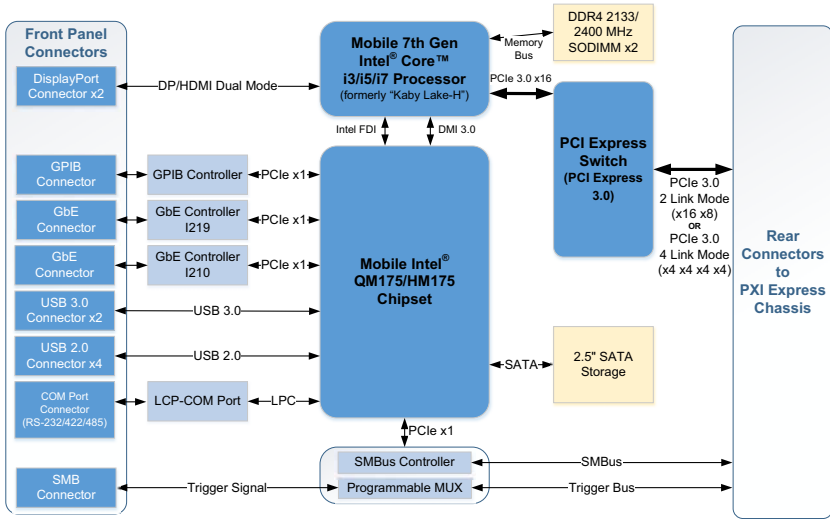

**Figure 1-1: Functional Block Diagram**

### Processor

- ▶ 7th Generation Intel® Core™ processor
- ▶ DMI (Direct Media Interface) 3.0 with 8 GT/s bandwidth in each direction

### Chipset

Mobile Intel® QM175/HM175 chipset

## Memory

- ▶ Two standard 260-pin DDR4 SO-DIMM sockets
- ▶ Supports 2133/2400 MHz RAM up to 32 GB total
- ▶ Supports non-ECC, unbuffered memory



NOTE:

The externally accessible SO-DIMM socket can accept replacement DDR4 DRAM DIMM modules. PCIe-3987/3977/3937 specifications and stability guarantees are only supported when ADLINK-provided DDR4 DRAM SO-DIMM modules are used.

## Video

- ▶ DisplayPort resolution up to 3840 x 2160 @ 60 Hz
- ▶ DVI (with passive DisplayPort-to-DVI adapter) resolution up to 1920 x 1200 @ 60 Hz



NOTE:

DisplayPort adapters for other standards are available, with maximum available resolution dependent on the adapter

## Storage

Built-in 2.5" 500 GB SATA hard drive or 240 GB SATA solid state hard drive.

## Ethernet Connectivity

Dual Gigabit Ethernet controllers through two RJ-45 connectors with speed/link/active LED on the faceplate, with both supporting Wake on LAN.

## USB

Four USB 2.0 and two USB 3.0 ports on the faceplate.

## GPIB

Onboard IEEE488 GPIB controller through Micro-D 25-pin connector on the faceplate.



## Trigger I/O

One SMB connector on the faceplate to route an external trigger signal to/from PXI trigger bus.

## Dimensions (3U PXI module)

3U/4-slot PXI standard

## Weight

1.0 kg (exclusive of packaging)

## Environmental

Condition	Range
Operating temperature with SSD	0 to 55°C
Operating temperature with HDD	0 to 50°C
Storage temperature	-20 to 70°C
Relative humidity, non-condensing	5 to 95%

## Shock and Vibration

Functional shock 30 G, half-sine, 11 ms pulse duration

Random vibration:

- ▶ Operating: 5 to 500 Hz, 0.21 Grms, 3 axes
- ▶ Non-operating: 5 to 500 Hz, 2.46 Grms, 3 axes



NOTE:

Environmental, shock, and vibration values are only valid with use of an ADLINK-provided SSD/HDD

---

## Certifications

Electromagnetic compatibility:

- ▶ EN 61326-1 (IEC 61326-1): Class A emissions; Basic immunity
- ▶ EN 55011 (CISPR 11): Group 1, Class A emissions
- ▶ EN 55032 2015/AC: 2016 Class A
- ▶ EN 55032 2015/AC: 2016 Class B
- ▶ EN 55024 2010+ A1: 2015
- ▶ EN 61000-3-2:2014: Class A
- ▶ EN 61000-3-3:2013: Class A
- ▶ EN 55024:2010+A1:2015: Immunity
- ▶ FCC 47 CFR Part 15 Subpart A (Class A)
- ▶ FCC 47 CFR Part 15 Subpart B (Class B)
- ▶ ICES-001 Class A
- ▶ ICES-003 Issue 6-2016
- ▶ AS/NZS CISPR 11: Group 1, Class A emissions
- ▶ AS/NZS CISPR 32: 2015 (Ed 2.0)/C1:2016: Class B

The PXIe-3987/3977/3937 meets the essential requirements of applicable European Directives.

## Power Requirements

Typical Consumption	DC +3.3V	DC +5V	DC +12V
Typical operation (Measured while W10 is idle)	5A	2.5A	2A
Heavy operation (Measured while W10 is under heavy CPU and storage utilization)	5A	2.8A	8A

## 1.3 I/O and Indicators

### 1.3.1 Front Panel

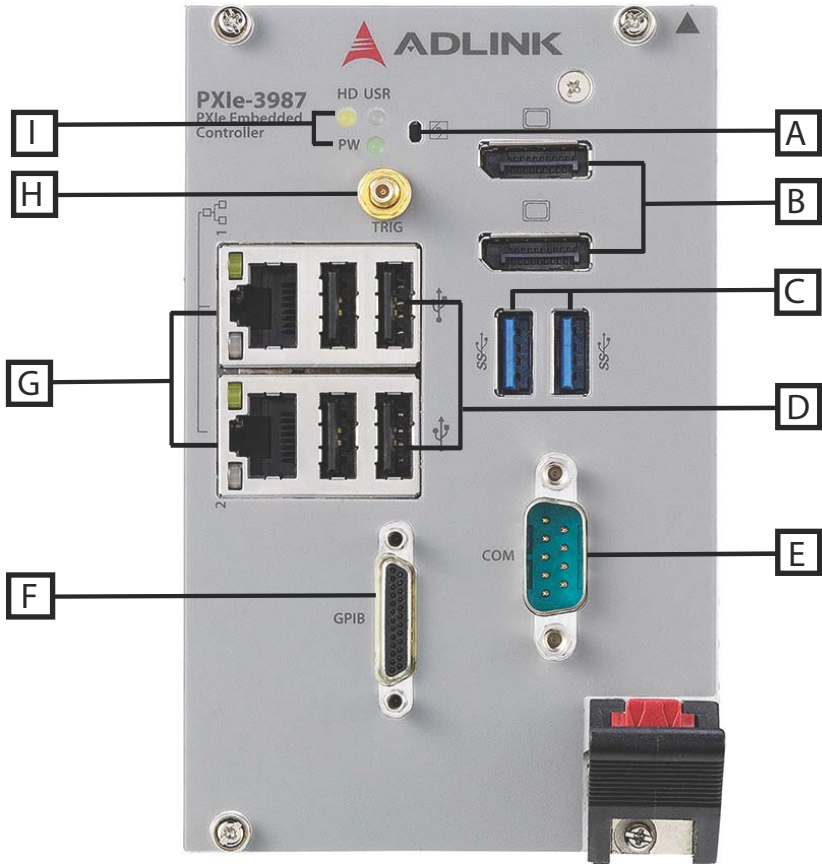
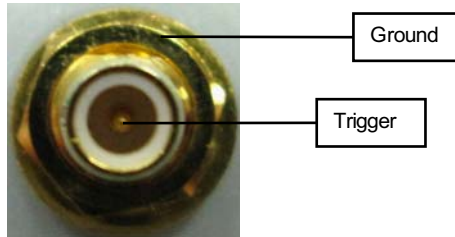

Figure 1-2: Front Panel

<b>A</b>	Reset Button	<b>F</b>	GPIB Connector (Micro D-Sub 25P)
<b>B</b>	2X DisplayPort	<b>G</b>	2X Gigabit Ethernet
<b>C</b>	2X USB 3.0	<b>H</b>	PXI Trigger
<b>D</b>	4X Type-A USB 2.0	<b>I</b>	LED indicators
<b>E</b>	COM port (D-sub9 serial)		

Table 1-1: Front Panel Legend

## PXI Trigger Connector



**Figure 1-3: PXI Trigger SMB Jack**

The PXI trigger connector is an SMB jack, used to route external trigger signals to or from the PXI backplane. Trigger signals are TTL-compatible and edge sensitive. The PXIe-3987/3977/3937 provides four trigger routing modes from/to the PXI trigger connector to synchronize PXI modules, including

- ▶ From a selected trigger bus line to PXI trigger connector
- ▶ From the PXI trigger connector to a selected trigger bus line
- ▶ From software trigger to a selected trigger bus line
- ▶ From software trigger to PXI trigger connector

All trigger modes are programmable by the provided driver.

## DisplayPort Connectors

Provide monitor connection with installation of requisite adapters required if connecting to VGA/DVI/HDMI monitors. Dual display function is also supported.

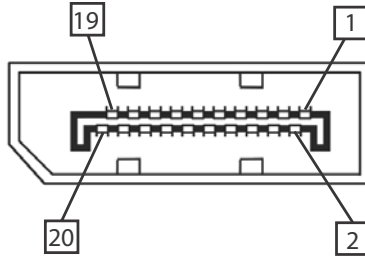

Figure 1-4: DisplayPort Connector

Pin	Signal	Pin	Signal
1	CN_DDPx0+	11	GND
2	GND	12	CN_DDPx3-
3	CN_DDPx0-	13	CN_DDPx_AUX_SEL
4	CN_DDPx1+	14	CN_DDPx_CONFIG2
5	GND	15	CN_DDPx_AUX+
6	CN_DDPx1-	16	GND
7	CN_DDPx2+	17	CN_DDPx_AUX-
8	GND	18	CN_DDPx_HPDP
9	CN_DDPx2-	19	GND
10	CN_DDPx3+	20	+V3.3_DDPx_PWR

Table 1-2: DisplayPort Pin Assignment

### 1.3.2 GPIB Connector

The GPIB connector is a micro D-sub 25P connector, controlling external bench-top instruments. Connection to other instruments requires the optional ACL-IEEE488-MD1-A cable. The onboard GPIB controller provides:

- ▶ Full compatibility with IEEE 488 standard
- ▶ Up to 1.5 MB/s data transfer rates
- ▶ Onboard 2 KB FIFO for read/write operations
- ▶ Driver APIs are compatible with NI-488.2 driver software
- ▶ Connection with up to 14 instruments

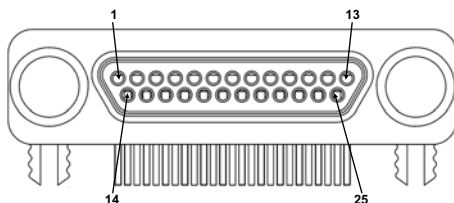

**Figure 1-5: GPIB Connector**

Pin	Signal	Description	Pin	Signal	Description
1	DIO1#	GPIB Data 1	14	DIO5#	GPIB Data 5
2	DIO2#	GPIB Data 2	15	DIO6#	GPIB Data 6
3	DIO3#	GPIB Data 3	16	DIO7#	GPIB Data 7
4	DIO4#	GPIB Data 4	17	DIO8#	GPIB Data 8
5	EOI	End Or Identify	18	REN	Remote Enable
6	DAV	Data Valid	19	Ground	Signal Ground
7	NRFD	Not Ready For Data	20	Ground	Signal Ground
8	NDAC	No Data Accepted	21	Ground	Signal Ground
9	IFC	Interface Clear	22	Ground	Signal Ground
10	SRQ	Service Request	23	Ground	Signal Ground
11	ATN	Attention	24	Ground	Signal Ground
12	Chassis Ground	Chassis Ground	25	Ground	Signal Ground
13	Ground	Signal Ground			

**Table 1-3: GPIB Pin Description**

### 1.3.3 Reset Button

The reset button, activated by insertion of any pin-like implement, executes a hard reset for the PXIe-3987/3977/3937.

### 1.3.4 LED Indicators

Three LED indicators on the faceplate indicate operational status of the PXIe-3987/3977/3937, as follows.

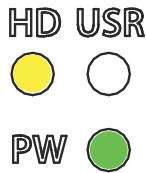

**Figure 1-6: LED Indicators**

LED	Color	Description
PW	Green	Indicates system power, remaining lit when the system boots normally and main power supply is functioning.
HD	Yellow	Indicates operating state of the HDD or SSD, flashing during access to or activity on the SATA HDD.
USR	Blue	User-programmable LED indicator.

**Table 1-4: LED Indicator Legend**

### 1.3.5 USB 2.0 Ports

The PXIe-3987/3977/3937 provides four USB 2.0 ports via USB Type-A connectors on the faceplate, all compatible with hi-speed, full-speed and low-speed USB devices. Supported boot devices include USB flash drive, USB floppy, USB CD-ROM, and others, with boot priority and device settings configured in BIOS. See section B.7: "Boot" on page 56 for more information.

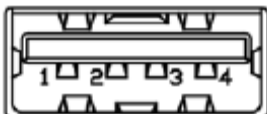

Pin	Signal
1/5	Power 5V
2/6	USB Data-
3/7	USB Data +
4/8	Ground

**Table 1-5: USB 2.0 Port Pin Assignment**



### 1.3.6 Gigabit Ethernet Ports

Dual Gigabit Ethernet connection is provided on the PX1e-3987/3977/3937 front panel.

Pin	1000Base-T Signal	100/10Base-T Signal
1	MDI0+	TX+
2	MDI0-	TX-
3	MDI1+	RX+
4	MDI2+	Reserved
5	MDI2-	Reserved
6	MDI1-	RX-
7	MDI3+	Reserved
8	MDI3-	Reserved

**Table 1-6: Ethernet Port Pin Assignments**

Each Ethernet port includes two LED indicators, one Active/Link indicator and one Speed indicator, functioning as follows.

	LED	Status	Description
	Active/Link (Yellow)	Off	Ethernet port is disconnected
		On	Ethernet port is connected with no data transmission
		Flashing	Ethernet port is connected with data transmitted/received
	Speed (Green/Orange)	Off	10 Mbps
		Green	100 Mbps
		Orange	1000 Mbps

**Table 1-7: Ethernet Status LED Descriptions**

### 1.3.7 USB 3.0 Ports

The PXIe-3987/3977/3937 provides two Type-A USB 3.0 ports on the front panel, supporting SuperSpeed, Hi-Speed, full-speed, and low-speed downstream transmission. Multiple boot devices, including USB flash, USB external HD, and USB CD-ROM drives are supported, with boot priority configured in BIOS.



NOTE:

USB 3.0 may not be supported by the OS installation programs/environment. Use USB 2.0 ports for OS installation if necessary.

### 1.3.8 COM Port

A COM port on the front panel with D-sub 9P connectors supports RS-232/RS-422/RS-485 by BIOS selection.

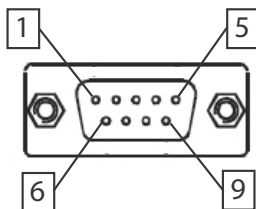
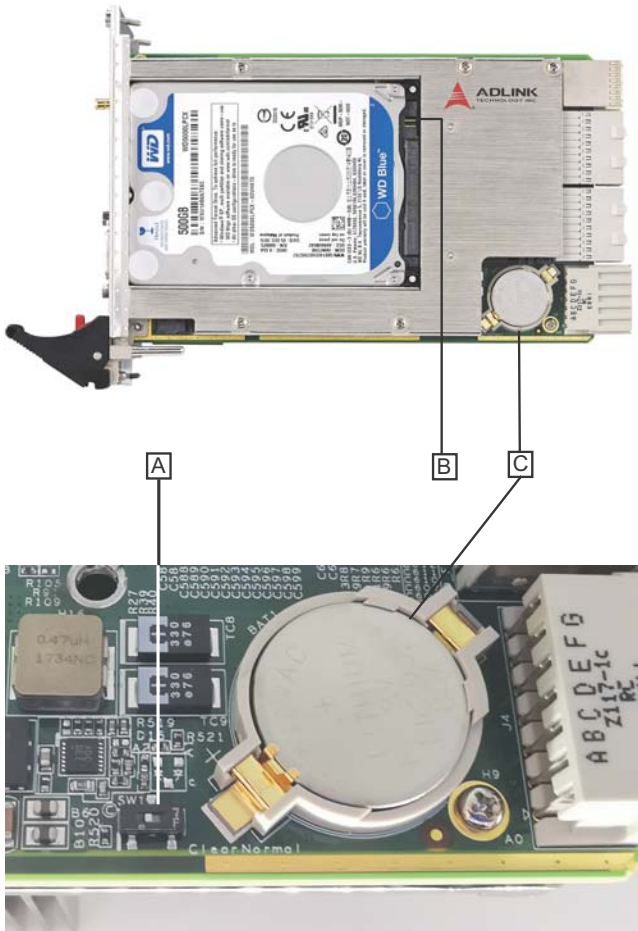

Figure 1-7: COM Port

Pin	Signal Name		
	RS-232	RS-422	RS-485
1	DCD#	TXD422-	485DATA-
2	RXD	TXD422+	485DATA+
3	TXD	RXD422+	N/S
4	DTR#	RXD422-	N/S
5	GND	N/S	N/S
6	DSR#	N/S	N/S
7	RTS#	N/S	N/S
8	CTS#	N/S	N/S
9	RI#	N/S	N/S

Table 1-8: D-sub COM Port Signal Functions

### 1.3.9 Onboard Connections and Settings



**Figure 1-8: Onboard Configuration**

<b>A</b>	Clear CMOS switch
<b>B</b>	SATA connector
<b>C</b>	System battery

**Table 1-9: Onboard Configuration Legend**

This page intentionally left blank.

## 2 Getting Started

This chapter describes procedures for installing the PXIe-3987/3977/3937 and making preparations for its operation, including hardware and software setup. Note that the PXIe controller is shipped with RAM and an HDD or SSD preinstalled. Contact ADLINK or an authorized dealer if there are any problems during the installation.



NOTE:

Diagrams and illustrated equipment are for reference only. Actual system configuration and specifications may vary.

---

### 2.1 Package Contents

Before beginning, check the package contents for any damage and ensure that the following items are included:

- ▶ PXIe-3987/3977/3937 Controller (equipped with RAM and HDD or SSD)
- ▶ PXIe-3987/3977/3937 Quick Start Guide

If any of these items are missing or damaged, contact the dealer from whom you purchased the product. Save the shipping materials and carton in case you want to ship or store the product in the future.



Do not install or apply power to equipment that is damaged or missing components. Retain the shipping carton and packing materials for inspection. Contact an ADLINK dealer/vendor immediately for assistance and obtain authorization before returning any product.

---

## 2.2 Operating System Installation

For more detailed information about the operating system, refer to the documentation provided by the operating system manufacturer. Preferred/supported operating systems for the PXIe controller are:

- ▶ Windows 10 64-bit
- ▶ For other OS support, contact ADLINK

Most operating systems require initial installation from a hard drive, floppy drive, or CD-ROM drive. The PXIe controller supports USB CD-ROM drive, USB flash disk, USB external hard drive, or a USB floppy drive as the first boot device. See section B.7: "Boot" on page 56 for information about setting the boot devices. These devices should be configured, installed, and tested with the supplied drivers before attempting to load the new operating system.



Read the release notes and installation documentation provided by the operating system vendor. Be sure to read all the README files or documents provided on the distribution disks, as these typically note documentation discrepancies or compatibility problems.

- 
1. Select the appropriate boot device order from the BIOS Boot Setup Menu based on the OS installation media used. For example, if the OS is distributed on a bootable installation CD, select USB CD-ROM as the first boot device and reboot the system with the installation CD in the USB CD-ROM drive.
  2. Proceed with the OS installation as directed and be sure to select appropriate device types if prompted. Refer to the appropriate hardware manuals for specific device types and compatibility modes of ADLINK PXI products.
  3. When installation is complete, reboot the system and set the boot device order in the BIOS Boot Setup Menu accordingly.

## 2.2.1 Installation Environment

When preparing to install any equipment described in this manual, first refer to Important Safety Instructions.

Only install equipment in well lit areas on flat, sturdy surfaces with access to basic tools such as flat- and cross-head screwdrivers, preferably with magnetic heads as screws and stand-offs are small and easily misplaced.

Recommended Installation Tools include:

- ▶ Phillips (cross-head) screwdriver
- ▶ Flat-head screwdriver
- ▶ Anti-static wrist strap
- ▶ Anti-static mat

ADLINK PXIe system controllers are electrostatically sensitive and can be easily damaged by static electricity. The equipment must be handled on a grounded anti-static mat, and operators must wear an anti-static wristband, grounded at the same point as the anti-static mat.

Inspect the carton and packaging for damage. Shipping and handling may cause damage to the contents. Ensure that all contents are undamaged before installing.



All equipment must be protected from static discharge and physical shock. Never remove any of the socketed parts except at a static-free workstation. Use the anti-static bag shipped with the product to handle the equipment and wear a grounded wrist strap when servicing or installing.

---

## 2.2.2 Installing the PXIe-3987/3977/3937

1. Remove all screw caps (x4).

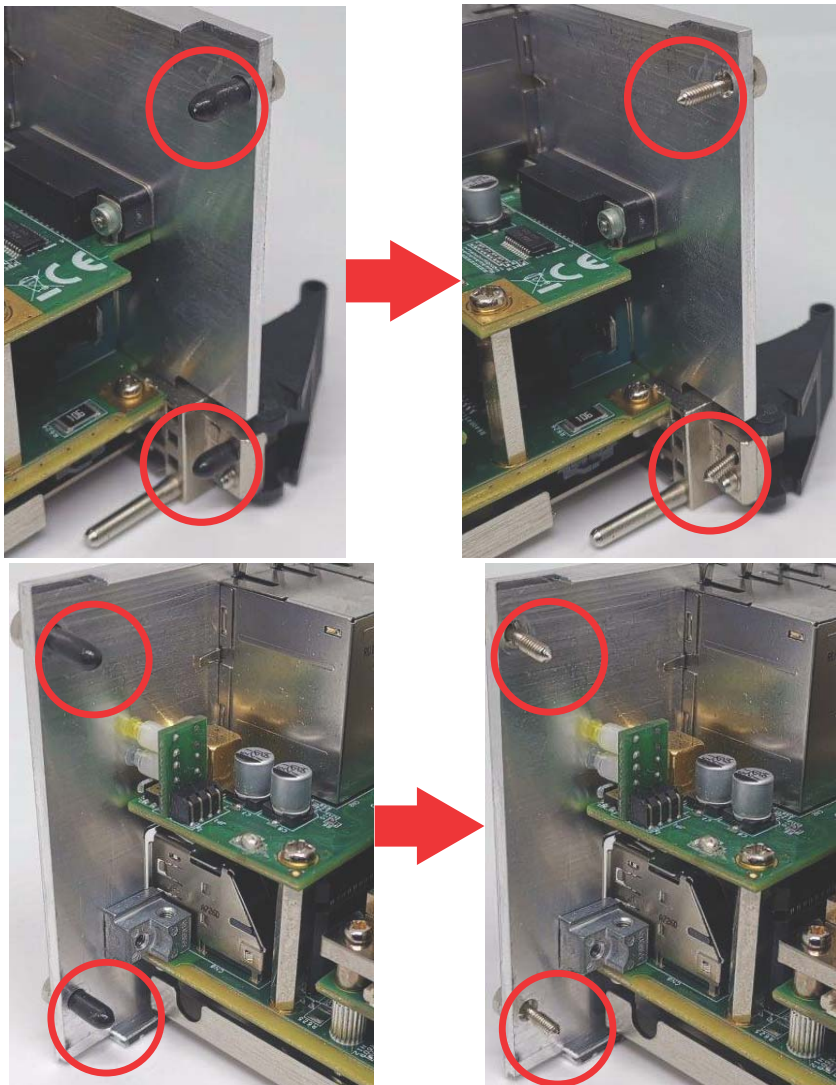



2. Release the red locking lever.

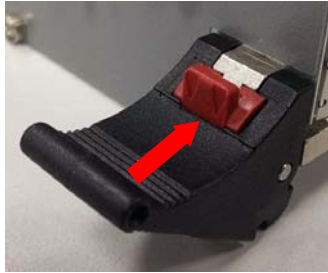

3. Depress the latch.



4. Locate the system controller slot of the chassis (Slot 1).



5. Align the controller's top and bottom edges with the card guides, and carefully slide the PXIe-3987/3977/3937 into the chassis, as shown.

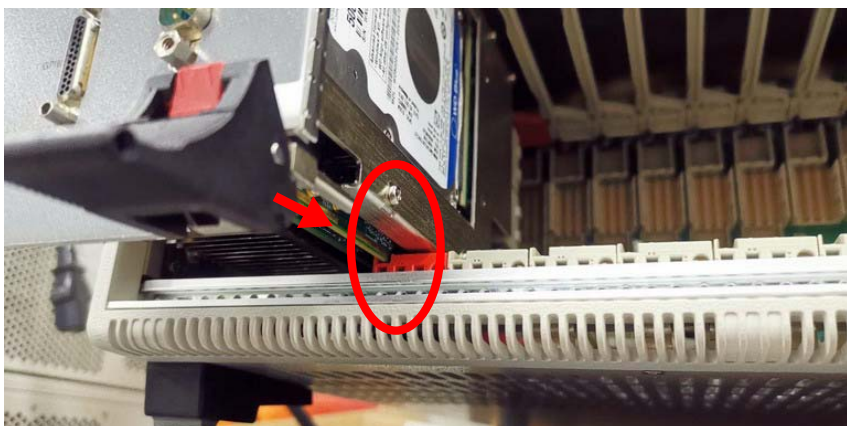
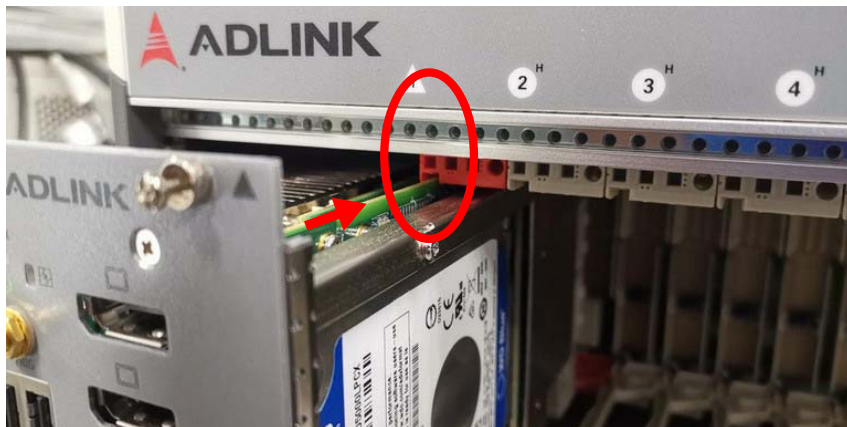

6. Elevate the latch until the PXIe-3987/3977/3937 is fully seated in the chassis backplane. The alignment pin on the rear of the latch can be threaded into the best fit alignment port in the chassis rail.
7. Fasten the four mounting screws on the faceplate and connect all peripheral devices.

### 2.2.3 Replacing the Hard Drive or Solid State Drive

The PXIe controller provides a SATA 3.0 port with a pre-installed 2.5" SATA hard drive or solid state drive. Replacing the HDD or SSD is accomplished as follows.

1. Locate the five screws attaching the hard drive housing to the PXIe controller, as shown.

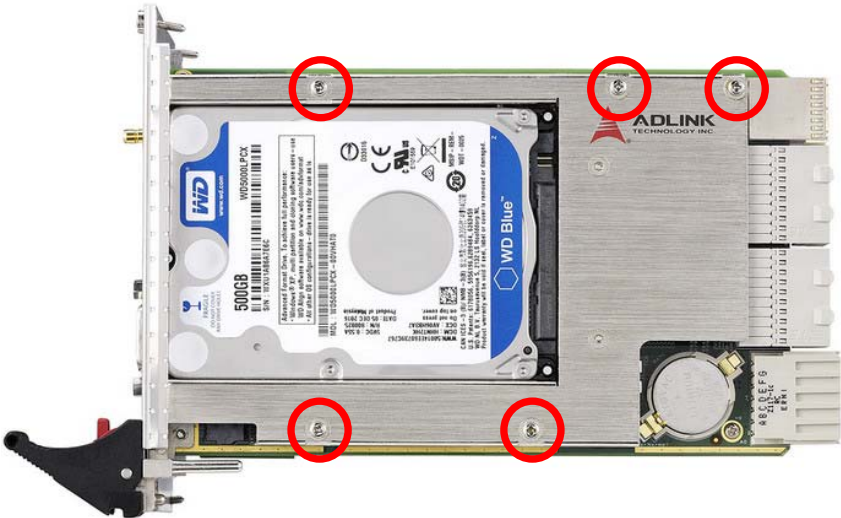

2. Remove the screws.
3. Gently lift and remove the housing with the installed HDD or SSD.

4. Locate the four screws (two on each side, as shown) fixing the hard drive, and remove them.

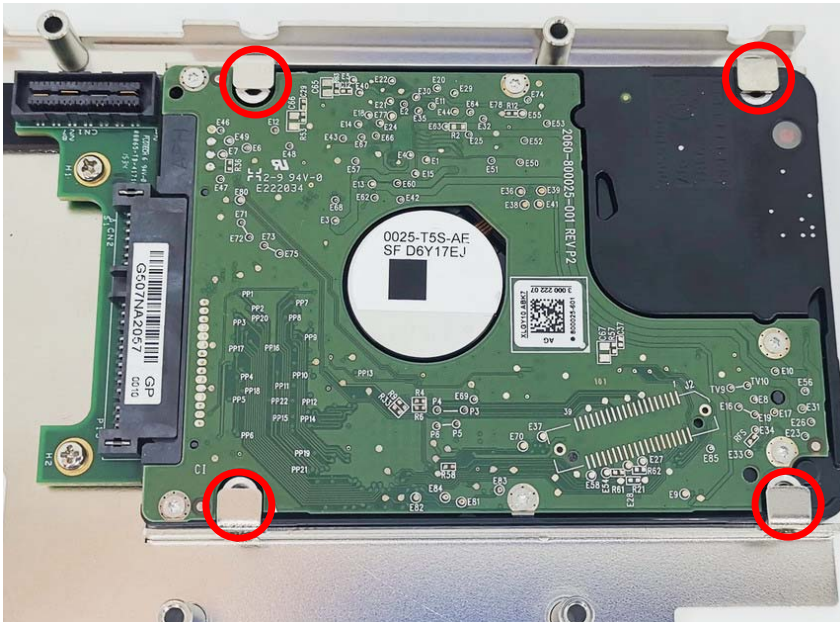

5. To install an HDD, SSD, or other compatible SATA hard drive, reverse the steps and reinstall the PXIe controller into the PXI system.

## 2.2.4 Replacing the Battery Backup

The PXIe-3987/3977/3937 is provided with a 3.0 V “coin cell” lithium battery, replacement of which is as follows.

1. Turn off the PXI chassis.
2. Remove the PXIe controller from the chassis. Observe all anti-static precautions.
3. To remove the battery, gently insert a small (approx. 5 mm) flathead screwdriver under the battery at the negative retaining clip. Gently pry up and the battery should easily pop out.

4. Place a fresh identical battery (CR2032 or equivalent) in the socket, ensuring that the positive pole (+) is facing upwards. The battery is most easily seated by first being inserted under the positive retaining clip, and then pushed downward at the negative retaining clip. The battery should easily snap into position.
5. Reinstall the PXIe controller into the PXI chassis and restore power.

## 2.2.5 Clearing CMOS

In the event of a system malfunction causing the PXIe controller to halt or fail to boot, clear the CMOS and restore the controller BIOS to its default settings. To clear the CMOS:

1. Shut down the controller operating system and turn off the PXI Chassis.
2. Remove the PXIe controller from the chassis. Observe all anti-static precautions.
3. Locate the CMOS clear switch (SW1) on the board (see section 1.3.9: "Onboard Connections and Settings" on page 15). Move the switch from the Normal position...



...to the Clear position.



Wait five seconds, then return the switch to the Normal position.



4. Remount the controller into the PXI chassis.
5. Press <Delete> or <ESC> to enter BIOS Setup when the splash logo appears.
6. Press <F9> to load optimized defaults in BIOS Setup.
7. Modify the system date and time.
8. Press <F10> to save configuration and exit.

### 3 Driver Installation

Windows 10 already carries most of the device drivers required by the PXIe-3987/3977/3937. Others can be downloaded from the ADLINK website after clicking “Driver” on any of the product pages for this series (the files are exactly the same for each product):

[www.adlinktech.com/Products/PXI\\_PXIe/PXIControllers/PXIe-3987](http://www.adlinktech.com/Products/PXI_PXIe/PXIControllers/PXIe-3987)  
[www.adlinktech.com/Products/PXI\\_PXIe/PXIControllers/PXIe-3977](http://www.adlinktech.com/Products/PXI_PXIe/PXIControllers/PXIe-3977)  
[www.adlinktech.com/Products/PXI\\_PXIe/PXIControllers/PXIe-3937](http://www.adlinktech.com/Products/PXI_PXIe/PXIControllers/PXIe-3937)

Use of Windows 10 requires the following drivers:

- ▶ Chipset Driver
- ▶ Graphics Driver
- ▶ Ethernet/LAN Driver
- ▶ PXI Trigger I/O Driver
- ▶ Intel ME Driver
- ▶ GPIB Driver
- ▶ Intel RST Driver

The following optional utility programs are also provided:

- ▶ MAPS Core Windows Software Suite for ADLINK Measurement, Automation, and PXI products
- ▶ PXI Platform Services

After downloading and extracting a given file, run the executable and follow its instructions to complete installation.

This page intentionally left blank.



## Appendix A PXI Trigger I/O Functions

This appendix describes use of the PXI trigger I/O function library for the PXIe-3987/3977/3937 controller, to program routing of trigger signals between the trigger I/O SMB connector on the faceplate and the PXI trigger bus on the backplane. API files are located in the installation directory of the PXI Trigger I/O driver.

### A.1 Data Types

The PXIe-3987/3977/3937 library uses these data types in `pxitrio.h` in the directory `X:\ADLINK\PXI Trigger IO\Include`. It is recommended that you use these data types in your application programs. The table shows the data type names, ranges, and corresponding data types in C/C++, Visual Basic, and Delphi for reference.

Type	Description	Range	Type		
			C/C++ (for 32-bit compiler)	Visual Basic	Pascal (Delphi)
U8	8-bit ASCII character	0 to 255	unsigned char	Byte	Byte
I16	16-bit signed integer	-32768 to 32767	short	Integer	SmallInt
U16	16-bit unsigned integer	0 to 65535	unsigned short	Not supported by BASIC, use the signed integer (I16) instead	Word
I32	32-bit signed integer	-2147483648 to 2147483647	long	Long	LongInt
U32	32-bit unsigned integer	0 to 4294967295	unsigned long	Not supported by BASIC, use the signed long integer (I32) instead	Cardinal

Type	Description	Range	Type		
			C/C++ (for 32-bit compiler)	Visual Basic	Pascal (Delphi)
F32	32-bit single- precision floating-point	-3.402823E38 to 3.402823E38	float	Single	Single
F64	64-bit double- precision floating-point	1.7976831348 62315E308 to 1.7976831348 62315E309	double	Double	Double

## A.2 Function Library

This section provides detailed definitions of the functions available in the PXIe-3987/3977/3937 function library. Each function includes a description, list of supported cards, syntax, parameter list and Return Code information.

### A.2.1 TRIG\_Init

#### Description

Initializes trigger I/O function of PXIe-3987/3977/3937 controller. TRIG\_Init must be called before the invocation of any other trigger I/O function.

#### Syntax

C/C++

```
I16 TRIG_Init()
```

Visual Basic

```
TRIG_Init As Integer
```

#### Parameter

*None*

#### Return Code

```
ERR_NoError
ERR_BoardBusy
ERR_OpenDriverFail
ERR_GetGPIOAddress
```

### A.2.2 TRIG\_Close

#### Description

Closes trigger I/O function of PXIe-3987/3977/3937 controller, releasing resources allocated for the trigger I/O function. Users must invoke TRIG\_Close before exiting the application.

#### Syntax

C/C++

```
I16 TRIG_Close()
```

## Visual Basic

```
TRIG_Close() As Integer
```

### Parameter

None

### Return Code

```
ERR_NoError  
ERR_BoardNoInit
```

## A.2.3 TRIG\_SetSoftTrg

### Description

Generates a TTL trigger signal to the trigger I/O SMB connector on the faceplate or the PXI trigger bus on the backplane by software command.

### Syntax

C/C++

```
I16 TRIG_SetSoftTrg(U8 Status)
```

### Visual Basic

```
TRIG_SetSoftTrg (ByVal status As Byte) As  
Integer
```

### Parameters

#### *Status*

Logic level of trigger signal.

*Available value description:*

0: Logic low

1: Logic high

### Return Code

```
ERR_NoError  
ERR_BoardNoInit
```

## A.2.4 TRIG\_Trigger\_Route

### Description

Routes the trigger signal between the trigger I/O SMB connector on the faceplate and the PXI trigger bus on the backplane. This function also allows routing of the software-generated trigger signal to SMB connector or trigger bus.

### Syntax

C/C++

```
I16 TRIG_Trigger_Route (U32 source, U32 dest,
    U32 halfway)
```

### Visual Basic

```
TRIG_Trigger_Route (ByVal source As Long,
    ByVal dest As Long, ByVal halfway As Long) As
    Integer
```

### Parameters

*source*

Source of trigger routing can be one of the following values.

Available value	Description
PXI_TRIG_VAL_SMB	SMB connector on the faceplate
PXI_TRIG_VAL_SOFT	Software-generated trigger signal
PXI_TRIG_VAL_TRIG0	PXI trigger bus #0
PXI_TRIG_VAL_TRIG1	PXI trigger bus #1
PXI_TRIG_VAL_TRIG2	PXI trigger bus #2
PXI_TRIG_VAL_TRIG3	PXI trigger bus #3
PXI_TRIG_VAL_TRIG4	PXI trigger bus #4
PXI_TRIG_VAL_TRIG5	PXI trigger bus #5
PXI_TRIG_VAL_TRIG6	PXI trigger bus #6
PXI_TRIG_VAL_TRIG7	PXI trigger bus #7

*dest*

Destination of trigger routing can be one of the following.

Available value	Description
PXI_TRIG_VAL_SMB	SMB connector on the faceplate
PXI_TRIG_VAL_TRIG0	PXI trigger bus #0
PXI_TRIG_VAL_TRIG1	PXI trigger bus #1
PXI_TRIG_VAL_TRIG2	PXI trigger bus #2
PXI_TRIG_VAL_TRIG3	PXI trigger bus #3
PXI_TRIG_VAL_TRIG4	PXI trigger bus #4
PXI_TRIG_VAL_TRIG5	PXI trigger bus #5
PXI_TRIG_VAL_TRIG6	PXI trigger bus #6
PXI_TRIG_VAL_TRIG7	PXI trigger bus #7

*halfway*

Halfway point of trigger routing. This parameter is used only to route the software-generated trigger signal to the SMB connector on the faceplate. In this case, the halfway should be set as one of the trigger bus lines, otherwise as PXI\_TRIG\_VAL\_NONE.

Available value	Description
PXI_TRIG_VAL_NONE	No halfway point
PXI_TRIG_VAL_TRIG0	PXI trigger bus #0
PXI_TRIG_VAL_TRIG1	PXI trigger bus #1
PXI_TRIG_VAL_TRIG2	PXI trigger bus #2
PXI_TRIG_VAL_TRIG3	PXI trigger bus #3
PXI_TRIG_VAL_TRIG4	PXI trigger bus #4
PXI_TRIG_VAL_TRIG5	PXI trigger bus #5
PXI_TRIG_VAL_TRIG6	PXI trigger bus #6
PXI_TRIG_VAL_TRIG7	PXI trigger bus #7

## Return Code

```

ERR_NoError
ERR_BoardNoInit
ERR_Set_Path

```

## A.2.5 TRIG\_Trigger\_Clear

### Description

Clears the trigger routing setting.

### Syntax

C/C++

```
I16 TRIG_Trigger_Clear()
```

Visual Basic

```
TRIG_Trigger_Clear() As Integer
```

### Parameters

None

### Return Code

```
ERR_NoError  
ERR_BoardNoInit  
ERR_Trigger_Clr
```

## A.2.6 TRIG\_GetSoftTrg

### Description

Acquires the current software trigger state, with default state after system boot of Logic Low.

### Syntax

C/C++

```
I16 TRIG_GetSoftTrg(U8 *Status)
```

Visual Basic

```
TRIG_GetSoftTrg (status As Byte) As Integer
```

### Parameters

*Status*

Returns the logic level of software trigger signal.

Returned value:

0: Logic low

1: Logic high

## Return Code

ERR\_NoError  
 ERR\_BoardNoInit  
 ERR\_Query\_Status

## A.2.7 TRIG\_Trigger\_Route\_Query

### Description

Acquires the current trigger signal routing path.

### Syntax

C/C++

```
I16 TRIG_Trigger_Route_Query (U32* source,
U32* dest, U32* halfway)
```

### Visual Basic

```
TRIG_Trigger_Route_Query (source As Long, dest
As Long, halfway As Long) As Integer
```

### Parameters

*source*

Returns to the current source of trigger routing, with possible values including:

Available Definition	Defined Value
PXI_TRIG_VAL_NONE	0
PXI_TRIG_VAL_SMB	2
PXI_TRIG_VAL_SOFT	3
PXI_TRIG_VAL_TRIG0	111
PXI_TRIG_VAL_TRIG1	112
PXI_TRIG_VAL_TRIG2	113
PXI_TRIG_VAL_TRIG3	114
PXI_TRIG_VAL_TRIG4	115
PXI_TRIG_VAL_TRIG5	116
PXI_TRIG_VAL_TRIG6	117
PXI_TRIG_VAL_TRIG7	118



*dest*

Returns to the current destination of trigger routing, with possible values including:

Available Definition	Defined Value
PXI_TRIG_VAL_NONE	0
PXI_TRIG_VAL_SMB	2
PXI_TRIG_VAL_TRIG0	111
PXI_TRIG_VAL_TRIG1	112
PXI_TRIG_VAL_TRIG2	113
PXI_TRIG_VAL_TRIG3	114
PXI_TRIG_VAL_TRIG4	115
PXI_TRIG_VAL_TRIG5	116
PXI_TRIG_VAL_TRIG6	117
PXI_TRIG_VAL_TRIG7	118

*halfway*

Returns to the current halfway point of trigger routing, with possible values including:

Available Value	Description
PXI_TRIG_VAL_NONE	0
PXI_TRIG_VAL_TRIG0	111
PXI_TRIG_VAL_TRIG1	112
PXI_TRIG_VAL_TRIG2	113
PXI_TRIG_VAL_TRIG3	114
PXI_TRIG_VAL_TRIG4	115
PXI_TRIG_VAL_TRIG5	116
PXI_TRIG_VAL_TRIG6	117
PXI_TRIG_VAL_TRIG7	118

**Return Code**

ERR\_NoError  
 ERR\_BoardNoInit  
 ERR\_Query\_Status

## A.2.8 TRIG\_GetDriverRevision

### Description

Acquires the PXI Trigger software driver version; format of the version number is major.minor1.minor2.

### Syntax

C/C++

```
I16 TRIG_GetDriverRevision(unsigned short  
*major, unsigned short *minor1, unsigned short  
*minor2)
```

Visual Basic

```
TRIG_GetDriverRevision (major As Integer,  
minor1 As Integer, minor2 As Integer) As Integer
```

### Parameters

*major*

Returns the major version number of the pxi trigger software driver

*minor1*

Returns the first minor version number of the pxi trigger software driver

*minor2*

Returns the second minor version number of the pxi trigger software driver

### Return Code

```
ERR_NoError  
ERR_Query_Revision
```

# Appendix B BIOS Setup

## B.1 Entering the BIOS

1. Power on or reboot the PXIe-3987/3977/3937 controller.
2. Press the <Delete> or <Esc> key when the controller beeps. This should be concurrent with the main startup screen. The BIOS setup program loads after a short delay.
3. The Main menu is displayed when you first enter the BIOS setup program.

The main BIOS setup menu is the first screen that you can navigate. Each main BIOS setup menu option is described in this chapter.

The Main BIOS setup menu screen has two main frames. The left frame displays all the options that can be configured. “Grayed” options cannot be configured, “Blue” options can.

The right frame displays the key legend. Above the key legend is an area reserved for a text message. When an option is selected in the left frame, it is highlighted in white. Often a text message will accompany it.

## B.2 Navigation

The BIOS setup utility uses a key-based navigation system called hot keys. Most hot keys can be used at any time during navigation.

Key(s)	Function
Right Arrow, Left Arrow	Moves between different setup menus
Up Arrow, Down Arrow	Moves between options within a setup menu
<Enter>	Opens a sub-menu or displays all available settings for a highlighted configuration option
<Esc>	Returns to the previous menu and shortcuts to the Exit menu from top-level menus
<+> and <->	Cycles between all available settings
<Tab>	Selects time and date fields
<F1>	Opens the general help window for the BIOS
<F8>	Loads previous values into the BIOS
<F9>	Restores optimal default values into the BIOS
<F10>	Saves the current configuration and exits BIOS setup

**Table B-1: BIOS Hot Key Functions**

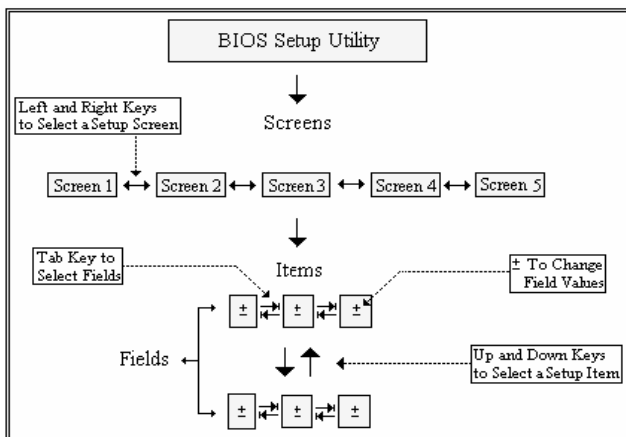

**Figure B-1: BIOS Setup Navigation**



NOTE:

A hot key legend is located in the right frame on most setup screens.

## B.3 Menu Structure

This section presents the primary menus of the BIOS Setup Utility. Use the following table as a quick reference for the contents of the BIOS Setup Utility. The sub-sections that follow provide further details for each top-level menu and sub-menu and the setting options for each menu item. Default setting options are presented in **bold** and the function of each setting is described in the right hand column of the respective table.

<b>Main</b>	BIOS Information Processor Information PCH Information System Management ► System Date and Time
<b>Advanced</b>	CPU Configuration ► Memory Configuration ► Graphics Configuration ► USB Configuration ► TPM 2.0 Configuration ► Onboard Devices Configuration ► PCI and PCIe Configuration ► Advanced Power Management ► Network Stack Configuration ► Hardware Health Configuration ► PXIe Links Control Configuration ►
<b>Security</b>	Password Description Administrator Password User Password Secure Boot ►
<b>Boot</b>	Boot Configuration CSM ► FIXED BOOT ORDER Priorities UEFI Hard Disk Drive BBS Priorities ►
<b>Save &amp; Exit</b>	Save Options Default Options Boot Override

Note: ► indicates a sub-menu

## B.4 Main

The Main Menu provides read-only information about your system and also allows you to set the System Date and Time. Refer to the tables below for details about each section/sub-menu.

### B.4.1 BIOS Information

Feature	Options	Description
BIOS Vendor	Info only	American Megatrends
Core Version	Info only	Displays Core version
Compliance	Info only	Displays compliance information
Project Version	Info only	ADLINK BIOS version
Build Date and Time	Info only	Date the ADLINK BIOS was built
Access Level	Info only	Current BIOS menu access permission
Link Cap	Info only	PCI Express link configuration to PXIe chassis 2 link configuration: x8 x16 4 link configuration: x4 x4 x4 x4

### B.4.2 Processor Information

Feature	Options	Description
Name	Info only	Displays CPU brand name
CPU Signature	Info only	Displays CPU signature
CPU Speed	Info only	Displays CPU frequency
Processor ID	Info only	Displays CPU ID
Stepping	Info only	Displays CPU stepping
Number of Processors	Info only	Displays number of processors
GT Info	Info only	Displays GT info of Intel Graphics
GOP Version	Info only	Graphics Output Protocol version
Memory RC Version	Info only	Displays memory version
Total Memory	Info only	Displays installed memory size
Memory Frequency	Info only	Displays memory frequency

### B.4.3 PCH Information

Feature	Options	Description
Name	Info only	Displays PCH name
PCH SKU	Info only	Displays PCH SKU
Stepping	Info only	Displays PCH stepping
LAN PHY Revision	Info only	Displays LAN PHY revision
ME FW Version	Info only	Displays version of ME
ME Firmware SKU	Info only	Displays ME Firmware Kit SKU number

### B.4.4 System Management

The System Management sub-menu contains the following six sub-menus with read-only system information as well as the option to change the machine's Power-up Mode.

#### B.4.4.1 Board Information

Board Information	Options	Description
SEMA Firmware	Info only	Displays SEMA firmware
Build Date	Info only	Displays SEMA firmware build date
SEMA Boot Loader	Info only	Displays SEMA boot loader
Build Date	Info only	Displays SEMA boot loader build date
Hardware Version	Info only	Displays SEMA hardware version
Serial Number	Info only	Displays SEMA S/N
Manufacturing Date	Info only	Displays SEMA manufacture date
Last Repair Date	Info only	Displays last SEMA repair date
MAC ID	Info only	Displays SMC MAC ID

## B.4.4.2 Temperatures

Feature	Options	Description
CPU Temperature		
Current	Info only	Displays current CPU temperature
Startup	Info only	Displays CPU startup temperature
Min	Info only	Displays min. CPU temperature
Max	Info only	Displays max. CPU temperature
Board Temperature		
Current	Info only	Displays current board temperature
Startup	Info only	Displays board startup temperature
Min	Info only	Displays min. board temperature
Max	Info only	Displays max. board temperature

## B.4.4.3 Power Consumption

Feature	Options	Description
Current Input Current	Info only	Displays input current
Current Input Power	Info only	Displays input power
VCORE	Info only	Displays actual voltage of the VCC_CORE
VGFX	Info only	Displays actual voltage of the VGFX
VMEM	Info only	Displays actual voltage of the VMEM
5VSB	Info only	Displays actual voltage of the 5VSB
VIN	Info only	Displays actual voltage of the VIN
5V	Info only	Displays actual voltage of the 5V
3.3V	Info only	Displays actual voltage of the 3.3V
3.3VSB	Info only	Displays actual voltage of the 3.3VSB



#### B.4.4.4 Runtime Statistics

Feature	Options	Description
Total Runtime	Info only	Specifies the total time in minutes the system has spent running in S0 state
Current Runtime	Info only	Specifies the time in seconds the system has been running in S0 state, where the counter is cleared when the system is removed from the external power supply
Power Cycles	Info only	Specifies the number of times external power has been shut off
Boot Cycles	Info only	Boot count is increased after a HW- or SW-Reset or successful power-up
Boot Reason	Info only	Shows the event responsible for reboot of the system

#### B.4.4.5 Flags

Feature	Options	Description
BMC Flags	Info only	
BIOS Select	Info only	Displays the current BIOS ROM selection
ATX/AT-Mode	Info only	Displays ATX/AT mode
Exception Code	Info only	System exception reason

### B.4.4.6 Power Up

Feature	Options	Description
Power-up Mode (only in effect if the module is in ATX-Mode)	Turn on <b>Remain off</b> Last state	Turn on: The machine starts automatically when the power supply is turned on Remain off: The power button must be pressed to start the machine Last state: When power is lost and then restored, the machine will either turn on or remain off according to its last power state

### B.4.5 System Date and Time

Feature	Options	Description
System Date	Weekday, MM/DD/YYYY	Requires alpha-numeric entry of the day of the week, day of the month, calendar month, and all 4 digits of the year, indicating the century and year (Fri XX/XX/20XX)
System Time	HH/MM/SS	Presented as a 24-hour clock in hours, minutes, and seconds

## B.5 Advanced

Provides settings for most user interfaces in the system.

### B.5.1 CPU Configuration

Feature	Options	Description
CPU Signature	Info only	Displays CPU signature
Microcode Revision	Info only	Displays microcode revision
CPU Speed	Info only	Displays CPU operating frequency
Processor Cores	Info only	Displays Processor Cores
Hyper Threading Technology	Info only	Displays presence/absence of Intel Hyper Threading support
VMX	Info only	Displays presence/absence of Intel Virtualization Technology support
SMX/TXT	Info only	Displays presence/absence of Intel SMX Technology support
L1 Data Cache	Info only	Displays cache info
L1 Instruction Cache	Info only	Displays cache info
L2 Cache	Info only	Displays cache info
L3 Cache	Info only	Displays cache info
L4 Cache	Info only	Displays cache info
Hyper-Threading	Disabled <b>Enabled</b>	Enabled for Windows XP and Linux (OS optimized for Hyper-Threading Technology) and disabled for other OS (not optimized); when Disabled only one thread per enabled core is active
VT-d	Disabled <b>Enabled</b>	Enables/disables VT-d function on MCH
Intel (VMX) Virtualization Technology	Disabled <b>Enabled</b>	Enables/disables support for Intel Virtualization technology
Intel® SpeedStep(TM)	<b>Disabled</b> Enabled	Allows support for more than two frequency ranges

Feature	Options	Description
Turbo Mode	Disabled <b>Enabled</b>	Enables/disables turbo mode
Configurable TDP Boot Mode	<b>Nominal</b> Down Up Deactivated	Configures TDP Mode as Nominal/Down/Up/Deactivated, where Deactivated sets MSR to Nominal and MMI/O to Zero
Configurable TDP Lock	<b>Disabled</b> Enabled	Configurable TDP Mode Lock sets the Lock bits on TURBO_ACTIVATION_RATIO and CONFIG_TDP_CONTROL. When CTDP Lock is enabled, Custom ConfigTDP Count defaults to 1 and Custom ConfigTDP Boot Index to 0
Custom Configurable TDP	<b>Disabled</b> Enabled	Custom Configurable TDP settings
C States	Enabled <b>Disabled</b>	Enables/disables CPU C states
Package C State Limit	<b>CPU Default</b> C7 C6 C3 C2 C0/C1	Maximum Package C State limit
Intel Trusted Execution Technology	<b>Disabled</b> Enabled	Enables/disables Intel Trusted Execution Technology
DTS SMM	Disabled <b>Enabled</b> Critical Temp Reporting (out of spec)	Disabled: ACPI thermal management uses EC reported temperature Enabled: ACPI thermal management uses DTS SMM mechanism to determine CPU temperature Out of Spec: ACPI thermal management uses EC reported temperature and DTS SMM is used to handle Out of Spec
ACPI T-States	<b>Disabled</b> Enabled	Enables/disables ACPI 3.0 T-States

### B.5.2 Memory Configuration

Feature	Options	Description
Memory RC Version	Info only	Displays Memory Reference Code version
Memory Frequency	Info only	Displays memory frequency
Total Memory	Info only	Displays total memory
DIMM#0/1	Info only	Displays DIMM#0/1
Memory Timings (tCL-tRCD-tRP-tRAS)	Info only	Displays memory timings

### B.5.3 Graphics Configuration

Feature	Options	Description
GTT Size	2MB 4MB <b>8MB</b>	Selects Graphics Translation Table size
Aperture Size	128MB <b>256MB</b> 512M 1024MB 2048MB	Selects Aperture size
DVMT Pre-Allocated	0MB <b>32MB</b> 64MB	Selects DVMT Pre-Allocated (Fixed) Graphics Memory size used by the Internal Graphics Device
DVMT Total Gfx Mem	128MB <b>256MB</b> MAX	Selects DVMT Total Graphics Memory size used by the Internal Graphics Device

## B.5.4 USB Configuration

Feature	Options	Description
USB Module Version	Info only	
USB Devices	Info only	Lists USB-connected peripheral devices
USB Controllers	Info only	Display USB Controller type
Legacy USB Support	<b>Enabled</b> Disabled Auto	Enables legacy USB support, where Auto disables legacy support if no USB devices are connected, and Disable retains USB devices only for EFI applications and setup
XHCI Hand-off	<b>Enabled</b> Disabled	A workaround for OS without XHCI hand-off support. XHCI ownership change should be claimed by the XHCI OS driver
USB Mass Storage Driver Support	<b>Enabled</b> Disabled	Enables/disables USB Mass Storage driver support
Port 60/64 Emulation	<b>Enabled</b> Disabled	Enables I/O port 60h/64h emulation; should be enabled for complete USB keyboard legacy support for non-USB aware OS
USB Transfer Timeout	1 sec 5 sec 10 sec <b>20 sec</b>	Timeout value for Control, Bulk, and Interrupt transfers
Device Reset Timeout	10 sec <b>20 sec</b> 30 sec 40 sec	USB mass storage device Start Unit command timeout
Device Power-up Delay	<b>Auto</b> Manual	Maximum time before the device properly reports itself to the Host Controller. 'Auto' uses default value: for a Root port, 100 ms, for a Hub port the delay is taken from the Hub descriptor

### B.5.5 TPM 2.0 Configuration

Feature	Options	Description
Security Device Support	Disable <b>Enable</b>	Enable or disable BIOS support for security device
Active PCR Banks	Info only	
Available PCR Banks	Info only	
SHA-1 PCR Bank	<b>Enabled</b> Disabled	Enable or disable SHA-1 PCR Bank
SHA-256 PCR Bank	<b>Enabled</b> Disabled	Enable or disable SHA-256 PCR Bank
Pending Operation	<b>None</b> TPM Clear	Schedule an operation for the security device
Platform Hierarchy	Disabled <b>Enabled</b>	Enable or disable storage hierarchy
Storage Hierarchy	Disabled <b>Enabled</b>	Enable or disable storage hierarchy
Endorsement Hierarchy	Disabled <b>Enabled</b>	Enable or disable endorsement hierarchy
TPM2.0 UEFI Spec Version	TCG_1_2 <b>TCG_2</b>	TCG_1_2: Win8/10 compatibility mode TCG_2: New protocol and event format for Win10 or later
Physical Presence Spec Version	1.2 <b>1.3</b>	Instruct OS to support PPI spec version 1.2 or 1.3 (note that some HCK tests might not support version 1.3)
TPC 20 InterfaceType	Info only	

## B.5.6 Onboard Devices Configuration

Feature	Options	Description
Serial Port Configuration		
COM Device Settings	Info only	Serial port I/O address and IRQ
COM Control	<b>RS232</b> RS422 RS485	Selects serial port mode, from among RS232, RS422, and RS485
LAN Port Configuration		
LAN1 Controller	<b>Enabled</b> Disabled	Enables/disables onboard I219 LAN controller
LAN2 Controller	<b>Enabled</b> Disabled	Enables/disables onboard I210 LAN controller
SATA Configuration		
SATA Controller(s)	<b>Enabled</b> Disabled	Enables/disables SATA device
SATA Signal Setting	<b>HDD</b> SSD	Sets SATA signaling for optional HDD and SSD
Serial ATA Port X	Info only	Installed SATA device name
Software Preserve	Info only	Bootable OS in installed SATA device
Port X	Disabled <b>Enabled</b>	Enables/disables SATA port



### B.5.7 PCI and PCIe Configuration

Feature	Options	Description
Above 4G Decoding	<b>Disabled</b> Enabled	Enables/disables Memory Mapped I/O BIOS assignment above 4GB
Holdoff Timer	<b>0,1,2,3,4,5,6,7,8</b> sec	System delay for PCI Express Discovery
Native PCIe Enable	<b>Disabled</b> Enabled	Enables/disables native PCIe
PEG Port Configuration		
PEG 0:1:0	Info only	Information about PCI express mode and link to the PCI Express bus root
Max Link Speed	<b>Auto</b> Gen1 Gen2 Gen3	Sets maximum PCI Express link capability of the PCI Express bus root

### B.5.8 Advanced Power Management

Feature	Options	Description
RTC Wake System from S5	<b>Disabled</b> Fixed Time Dynamic Time	Enables/disables system wake on alarm event, from among Fixed Time, where system wakes at the setting time, and Dynamic Time, in which system wakes at setting time later
PCIe Wake	Enabled <b>Disabled</b>	Enables/disables PCI Express bus and onboard LAN2 Controller (I210) wake capability
I219 LAN Wake	Enabled <b>Disabled</b>	Enables/disables onboard LAN1 Controller (I219) wake capability

## B.5.9 Network Stack Configuration

Feature	Options	Description
Network Stack	Enabled <b>Disabled</b>	Enables/disables UEFI network stack
IPv4 PXE Support	Enabled <b>Disabled</b>	Enables/disables IPv4 PXE boot support
IPv6 PXE Support	Enabled <b>Disabled</b>	Enables/disables IPv6 PXE boot support
PXE Boot Wait Time	<b>0 sec</b>	Wait time for ESC key to abort PXE boot

## B.5.10 Hardware Health Configuration

Feature	Options	Description
Ambient temp of PCIe switch	Info only	Ambient temperature near PCIe switch
Core temp of PCIe switch	Info only	Core temperature of PCIe switch
+3.3V(System)	Info only	System +3.3V voltage
+5V(System)	Info only	System +5V voltage
+12V(System)	Info only	System +12V voltage
VBAT	Info only	Battery voltage

## B.5.11 PXIe Links Control Configuration

Feature	Options	Description
Link Configuration	Info only	PCI Express link configuration to PXIe chassis
Link 1 Width, Speed	Info only	Link lanes and mode
Max Link Speed	<b>Auto</b> Gen1 Gen2 Gen3	Maximum PCI Express link mode for Link 1
Link 2 Width, Speed	Info only	Link lanes and mode
Max Link Speed	<b>Auto</b> Gen1 Gen2 Gen3	Maximum PCI Express link mode

## B.6 Security

Feature	Options	Description
Password Description	Info only	Provides information about password characteristics as well as password length requirements: min. 3, max. 20
Administrator Password	Enter password	If ONLY the Administrator Password is set, then this only limits access to BIOS Setup and is only asked for when entering BIOS Setup
User Password	Enter password	If ONLY the User Password is set, then this is a power on password and must be entered to boot as well as to enter BIOS Setup and while in BIOS Setup the User will have Administrator rights
Secure Boot	Sub-menu	See section B.6.1 below

### B.6.1 Secure Boot

Feature	Options	Description
Attempt Secure Boot	<b>Disabled</b> Enabled	Determines whether Secure Boot will be attempted

## B.7 Boot

Feature	Options	Description
Boot Configuration		
Setup Prompt Timeout	1	Number of seconds to wait for setup activation key; to wait indefinitely, set to 65536 (0xFFFF)
Bootup NumLock State	<b>On</b> Off	Set keyboard NumLock state at boot
Quiet Boot	Disabled <b>Enabled</b>	Enable or disable Quiet Boot option
CSM	Sub-menu	See section B.7.2 on page 57
Fast Boot	<b>Disabled</b> Enabled	Enable or disable boot with initialization of a minimal set of devices required to launch active boot option; has no effect for BBS boot options
Boot Mode Select	<b>UEFI</b> Legacy	
FIXED BOOT ORDER Priorities	Boot Option #1 to Boot Option #8	Select which potential boot sources should be checked, and in what order, during the boot process
UEFI Hard Disk Drive BBS Priorities	Sub-menu	See section B.7.2 on page 57

### B.7.1 CSM

Feature	Options	Description
CSM Support	Enabled <b>Disabled</b>	Determines whether CSM will launch
CSM16 Module Version	Info only	Displays the CSM16 module version number
GateA20 Active	<b>Upon Request</b> Always	UPON REQUEST means GA20 can be disabled using BIOS services, ALWAYS means GA20 cannot be disabled; useful when any RT code is executed above 1MB
INT19 Trap Response	<b>Immediate</b> Postponed	BIOS reaction on INT19 trapping by Option ROM; IMMEDIATE executes trap immediately and POSTPONED executes trap during legacy boot
Boot Option Filter	<b>UEFI and Legacy</b> Legacy only UEFI only	Controls to which devices the system can boot
Option ROM Execution		
Network	<b>Do not launch</b> Legacy only UEFI only	Controls execution of UEFI and Legacy PXE OpROM
Storage	Do not launch <b>UEFI</b> Legacy only	Controls execution of UEFI and Legacy Storage OpROM
Video	Do not launch <b>UEFI</b> Legacy only	Controls execution of UEFI and Legacy Video OpROM
Other PCI Devices	<b>UEFI</b> Legacy	For PCI devices other than Network, Mass Storage, or Video, defines the OpROM to launch

### B.7.2 UEFI Hard Disk Drive BBS Priorities

Feature	Options	Description
Boot Option	Windows Boot Manager <b>Disable</b>	Allows specification of a UEFI HDD BBS priority boot option

## B.8 Save & Exit

Feature	Options	Description
Save Options		
Save Changes and Exit		Saves changes and exits system setup
Discard Changes and Exit		Discards changes and exits system setup
Save Changes and Reset		Saves changes and resets system
Discard Changes and Reset		Discards changes and resets system
Save Changes		Save changes made so far to setup options
Discard Changes		Discards changes made so far to setup options
Default Options		
Restore Defaults		Restores/loads default values for all setup options
Save as User Defaults		Saves changes made so far as User Defaults
Restore User Defaults		Restores User Defaults to all setup options
Boot Override		
Launch EFI Shell from filesystem device		Attempts to launch EFI shell application (shell.efi) from an available filesystem device

## Appendix C Dual BIOS

Dual BIOS is a backup function that maintains normal operation of the PXIe system module when unexpected boot failure occurs under the default BIOS. Dual BIOS consists of a main BIOS, a backup BIOS, and an independent controller. In normal boot, the main BIOS powers on and boots the system into the OS, monitored by the independent controller. If the main BIOS malfunctions, for example, as the result of corruption incurred by a failed update, boot procedure is terminated abnormally. The backup BIOS is then activated automatically to perform boot procedure. When backup BIOS is activated, during BIOS power-on, notifications are generated indicating that backup BIOS has been deployed. To restore main BIOS function, contact technical support.

This page intentionally left blank.



## Appendix D Legacy Boot Mode Settings

UEFI boot mode is default for the PXIe-3987/3977/3937 BIOS.

To boot in legacy boot mode, change related settings in the BIOS menu:

1. Power on and press <DEL> or <ESC> to enter BIOS menu
2. Move to Boot
3. Under “Boot mode select” select “LEGACY”
4. Move to Boot, CSM
5. Under “CSM Support” select “Enabled”
6. Under “Network” select “Legacy”
7. Under “Storage” select “Legacy”
8. Under “Video” select “Legacy”
9. Under “Other PCI devices” select “Legacy”
10. Press <F10> and <Enter> to save and exit BIOS menu.  
The system will restart and apply settings for Legacy boot mode.

To restore UEFI boot mode:

1. Power on and press <DEL> or <ESC> to enter BIOS menu
2. Press <F9> and <Enter> to load optimized defaults
3. Press <F10> and <Enter> to save and exit BIOS menu

The system restarts and default settings for UEFI boot mode are applied.

This page intentionally left blank.

## Important Safety Instructions

For user safety, please read and follow all instructions, Warnings, Cautions, and Notes marked in this manual and on the associated device before handling/operating the device, to avoid injury or damage.

*S'il vous plaît prêter attention stricte à tous les avertissements et mises en garde figurant sur l'appareil , pour éviter des blessures ou des dommages.*

- ▶ Read these safety instructions carefully.
- ▶ Keep the User's Manual for future reference.
- ▶ Read the Specifications section of this manual for detailed information on the recommended operating environment.
- ▶ The device can be operated at an ambient temperature of 55°C.
- ▶ When installing/mounting or uninstalling/removing device, or when removal of a chassis cover is required for user servicing (See "Getting Started" on page 17.):
  - ▷ Turn off power and unplug any power cords/cables.
  - ▷ Reinstall all chassis covers before restoring power.
- ▶ To avoid electrical shock and/or damage to device:
  - ▷ Keep device away from water or liquid sources.
  - ▷ Keep device away from high heat or humidity.
  - ▷ Keep device properly ventilated (do not block or cover ventilation openings).
  - ▷ Always use recommended voltage and power source settings.
  - ▷ Always install and operate device near an easily accessible electrical outlet.
  - ▷ Secure the power cord (do not place any object on/over the power cord).
  - ▷ Only install/attach and operate device on stable surfaces and/or recommended mountings.
- ▶ If the device will not be used for long periods of time, turn off and unplug it from its power source
- ▶ Never attempt to repair the device, which should only be serviced by qualified technical personnel using suitable tools

- ▶ A Lithium-type battery may be provided for uninterrupted backup or emergency power.



CAUTION:

Risk of explosion if battery is replaced with one of an incorrect type; please dispose of used batteries appropriately.

*Risque d'explosion si la pile est remplacée par une autre de type incorrect. Veuillez jeter les piles usagées de façon appropriée.*

- ▶ The device must be serviced by authorized technicians when:
  - ▷ The power cord or plug is damaged.
  - ▷ Liquid has entered the device interior.
  - ▷ The device has been exposed to high humidity and/or moisture.
  - ▷ The device is not functioning or does not function according to the User's Manual.
  - ▷ The device has been dropped and/or damaged and/or shows obvious signs of breakage.
- ▶ Disconnect the power supply cord before loosening the thumbscrews and always fasten the thumbscrews with a screwdriver before starting the system up.
- ▶ It is recommended that the device be installed only in a server room or computer room where access is:
  - ▷ Restricted to qualified service personnel or users familiar with restrictions applied to the location, reasons therefor, and any precautions required.
  - ▷ Only afforded by the use of a tool or lock and key, or other means of security, and controlled by the authority responsible for the location.

	<p><b>BURN HAZARD</b></p> <p>Touching this surface could result in bodily injury. To reduce risk, allow the surface to cool before touching.</p> <p><b>RISQUE DE BRÛLURES</b></p> <p><i>Ne touchez pas cette surface, cela pourrait entraîner des blessures.</i></p> <p><i>Pour éviter tout danger, laissez la surface refroidir avant de la toucher.</i></p>
--	---

# Getting Service

**Ask an Expert:** <http://askanexpert.adlinktech.com>

**ADLINK Technology, Inc.**

9F, No.166 Jian Yi Road, Zhonghe District  
New Taipei City 235, Taiwan  
Tel: +886-2-8226-5877  
Fax: +886-2-8226-5717  
Email: [service@adlinktech.com](mailto:service@adlinktech.com)

**Ampro ADLINK Technology, Inc.**

5215 Hellyer Avenue, #110  
San Jose, CA 95138, USA  
Tel: +1-408-360-0200  
Toll Free: +1-800-966-5200 (USA only)  
Fax: +1-408-360-0222  
Email: [info@adlinktech.com](mailto:info@adlinktech.com)

**ADLINK Technology (China) Co., Ltd.**

300 Fang Chun Rd., Zhangjiang Hi-Tech Park  
Pudong New Area, Shanghai, 201203 China  
Tel: +86-21-5132-8988  
Fax: +86-21-5132-3588  
Email: [market@adlinktech.com](mailto:market@adlinktech.com)

**ADLINK Technology GmbH**

Hans-Thoma-Strasse 11  
D-68163 Mannheim, Germany  
Tel: +49-621-43214-0  
Fax: +49-621 43214-30  
Email: [emea@adlinktech.com](mailto:emea@adlinktech.com)

Please visit the Contact page at [www.adlinktech.com](http://www.adlinktech.com) for information on how to contact the ADLINK regional office nearest you.