

ISA BUS SERIES

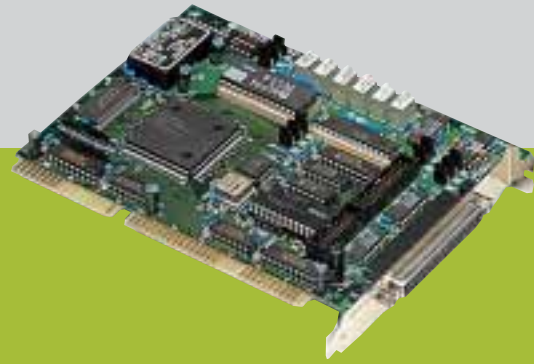

- F-04** Digital I/O Boards
- F-22** Analog I/O Boards
- F-36** Communication Boards
- F-39** Counter & Motor Controller

ISA BUS

With an ISA (Industry Standard Architecture) bus, IEEE (Institute of Electrical and Electronics Engineers) standardizes "AT bus" adopted as the IBM PC/AT compatible personal computer. Data bus width is also the general term of "XT bus" and 16-bit "AT bus" which is 8 bits. In a personal computer with the expansion slot of an ISA Bus, the board the "ISA Bus", "XT bus", and "AT bus [board]" were written can be used.

Set up

Many of devices which constitute a personal computer are operating using an I/O Port or an interruption (IRQ) level, and the specific address level is already used beforehand. The interface board of an ISA Bus must set up a different address level so that these devices may not conflict.

Windows XP/2000/ME/98/95

The definition file called device information (INF) file is attached to hardware or support software. If it sets up using this, it can set up smoothly, without being conscious of conflict with other devices.

MS-DOS and other operating systems.

Set up for I/O port address

It is set as the address which other devices are not using. The setting range of the I/O Address which our recommend is as follows.

● Recommendation set up for I/O Address

*300 - *31FH, *700 - *71FH, *B00 - *B1FH, *F00 - *F1FH
(* is the arbitrary numerical values of 0-FH)

● The example of a setting at the time of two or more board use

The bottom is an example in case the number of occupancy ports uses two or more boards of less than 16 ports.

1 sheet head I/O Address: 0300H	5 sheet head I/O Address: 1300H
2 sheet head I/O Address: 0700H	6 sheet head I/O Address: 1700H
3 sheet head I/O Address: 0B00H	7 sheet head I/O Address: 1B00H
4 sheet head I/O Address: 0F00H	8 sheet head I/O Address: 1F00H

Board size

Contec PCI boards come in three sizes:

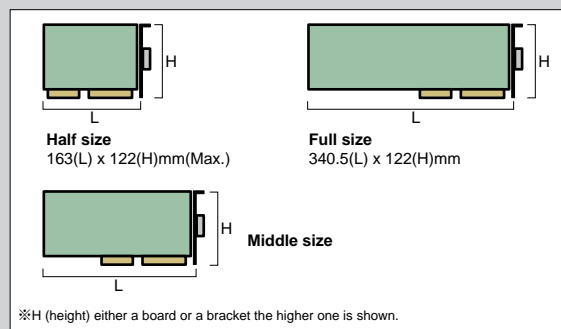

A setup of an interrupt (IRQ) level

Unlike a PCI bus, the interface board of an ISA Bus interrupts (IRQ), and sharing of a level cannot be performed. When using an interruption (IRQ) level, it sets up so that it may not compete with other devices. The next table is interruption (IRQ) level assignment of a common personal computer.

Controller 1	Controller 2	Device
IRQ0		Timer
IRQ1		Keyboard
IRQ2	IRQ8	Slave side
	IRQ9	Real-time clock
	IRQ10	Software interrupt
	IRQ11	Video
	IRQ12	Mouse
IRQ3	IRQ13	Math coprocessor
IRQ4	IRQ14	Hard disk drive
IRQ5	IRQ15	Serial port 2
IRQ6		Serial port 1
IRQ7		Floppy disk drive
		Parallel port 1

SELECTION GUIDE

F-02

ISA BUS SERIES

Name	Channels		Signal level	Response time	Isolation	Internal power	Input		Output	
	Input	Output					Input circuit	Input resistance	Output type	
Opto-Isolated Digital I/O Type										
PI-32L(PC)V	32	-	+12 - 24VDC	Max.1msec	○	-	Opto-Isolated Input (for current sinking output)	3KΩ	-	-
PI-64L(PC)	64	-	+12 - 24VDC	Max.1msec	○	-	Opto-Isolated Input (for current sinking output)	3KΩ	-	-
PI-32RL(PC)	32	-	+12 - 24VDC	Max.1msec	○	-	Opto-Isolated Input (for current sourcing output)	3KΩ	-	-
PO-32L(PC)V	-	32	+12 - 24VDC	Max.1msec	○	-	-	-	-	Opto-Isolated Open Collector Output (sinking type)
PO-64L(PC)	-	64	+12 - 24VDC	Max.1msec	○	-	-	-	-	Opto-Isolated Open Collector Output (sinking type)
PO-32RL(PC)	-	32	+12 - 24VDC	Max.1msec	○	-	-	-	-	Opto-Isolated Output (current sourcing)
PIO-16/16L(PC)V	16	16	+12 - 24VDC	Max.1msec	○	-	Opto-Isolated Input (for current sinking output)	3KΩ	-	Opto-Isolated Open Collector Output (sinking type)
PIO-32/32L(PC)	32	32	+12 - 24VDC	Max.1msec	○	-	Opto-Isolated Input (for current sinking output)	3KΩ	-	Opto-Isolated Open Collector Output (sinking type)
PIO-16/16RL(PC)	16	16	+12 - 24VDC	Max.1msec	○	-	Opto-Isolated Input (for current sourcing output)	3KΩ	-	Opto-Isolated Output (current sourcing)
PIO-32/32RL(PC)	32	32	+12 - 24VDC	Max.1msec	○	-	Opto-Isolated Input (for current sourcing output)	3KΩ	-	Opto-Isolated Output (current sourcing)
PIO-24/24(PC)	24	24	+12 - 24VDC	Max.1msec	○	-	Opto-Isolated Input (for current sinking output)	2KΩ	-	Opto-Isolated Open Collector Output (sinking type)
IRT-16(PC)	16	-	+12 - 24VDC	Max.1msec	○	-	TTL-level or Opto-isolated	2KΩ	-	-
Opto-Isolated Digital I/O Board with On-board 12V Power Supply										
PI-32B(PC)H	32	-	+12 - 24VDC	Max.1msec	○	DC12V	Opto-Isolated Input (for current sinking output)	3KΩ	-	-
PO-32B(PC)H	-	32	+12 - 24VDC	Max.1msec	○	DC12V	-	-	-	Opto-Isolated Open Collector Output (sinking type)
PIO-16/16B(PC)H	16	16	+12 - 24VDC	Max.1msec	○	DC12V	Opto-Isolated Input (for current sinking output)	3KΩ	-	Opto-Isolated Open Collector Output (sinking type)
PI-32TB(PC)	32	-	5VDC-TTL	Max.1μsec	○	DC5V	Opto-Isolated TTL Input	1.1KΩ	-	-
PO-32TB(PC)	-	32	5VDC-TTL	Max.1μsec	○	DC5V	-	-	-	Opto-Isolated TTL Output
PIO-16/16TB(PC)	16	16	5VDC-TTL	Max.1μsec	○	DC5V	Opto-Isolated TTL Input	1.1KΩ	-	Opto-Isolated TTL Output
Reed Relay Output Board										
RRY-32(PC)	-	32	AC/DC-100V	Max.1msec	○	-	-	-	-	Reed Relay Output
PRY-32(PC)	-	32	AC/DC-100V	Max.1msec	○	-	-	-	-	Photo MOS Relay Output
TTL-Level Digital I/O Board										
PI-32T(PC)H	32	-	5VDC-TTL	Max.200nsec	-	-	TTL level Input	10KΩ*1	-	-
PI-64T(PC)	64	-	5VDC-TTL	Max.200nsec	-	-	TTL level Input	10KΩ*1	-	-
PO-32T(PC)H	-	32	5VDC-TTL	Max.200nsec	-	-	-	-	-	32 TTL compatible digital outputs
PO-64T(PC)	-	64	5VDC-TTL	Max.200nsec	-	-	-	-	-	Open collector outputs
PIO-16/16T(PC)H	16	16	5VDC-TTL	Max.200nsec	-	-	TTL level Input	10KΩ*1	-	32 TTL compatible digital outputs
PIO-32/32T(PC)	32	32	5VDC-TTL	Max.200nsec	-	-	TTL level Input	10KΩ*1	-	Open collector outputs
Bi-Directional Digital I/O Board										
PIO-48D(PC)	48	-	5VDC-TTL	Max.200nsec	-	-	TTL level Input	10KΩ*1	-	TTL level Output with buffer
PIO-48W(PC)	48	-	5VDC-TTL	Max.200nsec	-	-	TTL level Input	10KΩ*1	-	TTL level Output
PIO-96W(PC)	96	-	5VDC-TTL	Max.200nsec	-	-	TTL level Input	20KΩ*1	-	TTL level Output
PIO-120D(PC)	120	-	5VDC-TTL	Max.200nsec	-	-	TTL level Input	10KΩ*1	-	TTL level Output with buffer
PIO-144W(PC)	144	-	5VDC-TTL	Max.200nsec	-	-	TTL level Input	22Ω	-	TTL level Output

*1 :it shows Pulling up resistance in this type.
*2 :16 output channels share one common when outside power supply is used.

ISA BUS Series Selection Guide

Digital I/O Boards

Analog I/O Boards

Communication Boards

Counter & Motor Controller

Name	Resolution (bit)	Channels*		Range			Conversion Speed	Trigger (Start / Stop)			Clock		Memory
		SE	DI	Range	Set up	Software		Digital trigger	Level	Timer	Digital trigger		
Multi-Function A/D Boards (E series)													
AD12-16(PC)EH	12	16	8	±10V, 0-10V			Common	10 μsec	○	○	○	○	FIFO/Ring 256Kword
AD12-16U(PC)EH	12	16	8	±5V, ±2.5V, 0-10V, 0-5V			Common	1 μsec	○	○	○	○	FIFO/Ring 256Kword
AD16-16(PC)EH	16	16	8	±10V, ±5V, 0-10V, 0-5V			Common	10 μsec	○	○	○	○	FIFO/Ring 256Kword
AD16-16U(PC)EH	16	16	8	±10V, ±5V, ±2.5V, 0-10V, 0-5V			Common	1 μsec	○	○	○	○	FIFO/Ring 256Kword
Analog To Digital Inputs Boards													
AD12-16(PC)	12	16	8	±10V, ±5V, 0-10V			Common	20 μsec	○	○	○	○	-
AD12-8LT(PC)	12	8	-	±5V			Common	25 μsec	○	○	○	○	-
AD12-16LG(PC)	12	16	-	±5V			Common	15 μsec	○	○	○	○	-
AD12-16(PC)	12	16	8	±10V, ±5V, 0-10V, 4-20mA			Common	25 μsec	○	○	○	○	-
AD12-8CL(PC)H	12	-	8	0-5V, 1-5V, 0-20mA, 4-20mA			Common	1200 μsec	○	○	○	○	-
Digital To Analog Output Boards													
DA12-4(PC)	12	4	-	±10V, ±5V, 0-10V			Independent	5 μsec	○	○	○	○	-
DA12-6LC(PC)	12	6	-	±10V, ±5V, ±2.5V, 0-10V, 0-5V, 4-20mA			Independent	4 μsec	○	○	○	○	-
DA12-8L(PC)	12	8	-	±10V, ±5V, 0-10V, 4-20mA(1ch)			Independent	10 μsec	○	○	○	○	-
DA12-4C(PC)	12	4	-	0-5V, 4-20mA			Independent	24 μsec	○	○	○	○	-
DA12-8C(PC)	12	8	-	0-5V, 4-20mA			Independent	24 μsec	○	○	○	○	-
DA16-4D(PC)	16	4	-	±10V, 0-10V			Independent	13 μsec	○	○	○	○	-

* SE: single-ended input, DI: Differential input

Name	Channels	Interface Type					Speed[bps]	Isolation	Connector	Software		Page
		RS-232C	RS-422A	RS-485	Async.	Sync.				COM-DRV(W32)	API-PAC(W32)	
RS-232C												
COM-2(PC)F	2	○	×	×	○	×	50 - 115200	×	9-pin D-type	○	○	F-36
RS-232C Intelligent type												
COM-2S(PC)	2	○	×	×	○	×	300 - 19200	×	9-pin D-type	×	○	F-36
Isolated type (RS-422A/RS-485)												
COM-2PD(PC)H	2	×	○	○	○	×	50 - 921600	○	9-pin D-type	○	○	F-36
RS-232C/RS-422A												
COM-4M(PC)	4	○	○	×	○	×	50 - 38400	×	37-pin D-type	○	○	F-36

Name	IEEE-488.1	IEEE-488.2	Speed	FIFO memory	Bus analyzer function	Software		Page
						ACX-PAC(W32)	API-PAC(W32)	
GP-IB(PC)F	○	○	Using FIFO:1MByte/sec (Receiver) 700kByte/sec (Sender)	○	×	○	○	F-37
GP-IB(PC)L	○	○	Normal:120kByte/sec (Max.) DMA : 400KByte/sec(Max.)	×	×	○	○	F-37
GP-IB(PC)	○	×	DMA : 300KByte/sec (Max.)	×	×	○	○	F-37

Output rating	Common	Expansion function	Interrupt	Connector	Software			Page	Name
					ACX-PAC(W32)	API-PAC(W32)	DDE SERVER(W32)		
-	16	-	2 interrupt lines use two IRQs	37-pin D-type	○	○	○	F-04	PI-32L(PC)V
-	16	○	4 interrupt lines use four IRQs	96-pin Half Pitch	○	○	○	F-05	PI-64L(PC)
-	16	-	2 interrupt lines use two IRQs	37-pin D-type	○	○	○	F-04	PI-32RL(PC)
+35VDC 100mA	16	-		37-pin D-type	○	○	○	F-06	PO-32L(PC)V
+35VDC 100mA	16	○		96-pin Half Pitch	○	○	○	F-08	PO-64L(PC)
+35VDC 150mA	16	-		37-pin D-type	○	○	○	F-06	PO-32RL(PC)
+35VDC 100mA	16	-	2 interrupt lines use two IRQs	37-pin D-type	○	○	○	F-08	PIO-16/16L(PC)V
+35VDC 100mA	16	○	4 interrupt lines use four IRQs	96-pin Half Pitch	○	○	○	F-10	PIO-32/32L(PC)
+35VDC 150mA	16	-	2 interrupt lines use two IRQs	37-pin D-type	○	○	○	F-09	PIO-16/16RL(PC)
+35VDC 150mA	16	○	4 interrupt lines use four IRQs	96-pin Half Pitch	○	○	○	F-11	PIO-32/32RL(PC)
+35VDC 200mA	16 or 8	-	4 interrupt lines use four IRQs	37-pin D-type	○	○	○	F-10	PIO-24/24(PC)
-	8	-	8 interrupt signals, 1 interrupt request	37-pin D-type	○	○	○	F-13	IRT-16(PC)
-	common for All the channels*2	-	2 interrupt lines use two IRQs	37-pin D-type	○	○	○	F-04	PI-32B(PC)H
+35VDC 100mA	common for All the channels*2	-	2 interrupt lines use two IRQs	37-pin D-type	○	○	○	F-07	PO-32B(PC)H
+35VDC 100mA	common for All the channels*2	-	2 interrupt lines use two IRQs	37-pin D-type	○	○	○	F-09	PIO-16/16B(PC)H
-	common for All the channels*2	-	2 interrupt lines use two IRQs	37-pin D-type	○	○	○	F-05	PI-32TB(PC)
+5VDC 6.4mA	common for All the channels*2	-	2 interrupt lines use two IRQs	37-pin D-type	○	○	○	F-07	PO-32TB(PC)
+5VDC 6.4mA	common for All the channels*2	-	2 interrupt lines use two IRQs	37-pin D-type	○	○	○	F-10	PIO-16/16TB(PC)
AC/DC100V 0.5A	8	-		37-pin D-type	○	○	○	F-13	RRY-32(PC)
AC/DC100V 250mA	8	-		37-pin D-type	○	○	○	F-13	PRY-32(PC)
-	common for All the channels	-	2 interrupt lines use two IRQs	37-pin D-type	○	○	○	F-05	PI-32T(PC)H
-	common for All the channels	○	4 interrupt lines use four IRQs	96-pin Half Pitch	○	○	○	F-06	PI-64T(PC)
+35VDC 40mA	common for All the channels	-		37-pin D-type	○	○	○	F-07	PO-32T(PC)H
+30VDC 40mA	common for All the channels	○		96-pin Half Pitch	○	○	○	F-08	PO-64T(PC)
+35VDC 40mA	common for All the channels	-	2 interrupt lines use two IRQs	37-pin D-type	○	○	○	F-09	PIO-16/16T(PC)H
+30VDC 40mA	common for All the channels	○	4 interrupt lines use four IRQs	96-pin Half Pitch	○	○	○	F-11	PIO-32/32T(PC)
+5VDC 24mA	common for All the channels	-	4 interrupt lines use four IRQs	50-pin Header	○	○	○	F-11	PIO-48D(PC)
+5VDC 21mA	common for All the channels	-	4 interrupt lines use four IRQs	37-pin D-type	○	○	○	F-12	PIO-48W(PC)
+5VDC 21mA	common for All the channels	-	8 interrupt signals, 1 interrupt request	30-pin Header Connector	○	○	○	F-12	PIO-96W(PC)
+5VDC 24mA	common for All the channels	-	10 interrupt signals, 1 interrupt request	50-pin Header	○	○	○	F-12	PIO-120D(PC)
+5VDC 21mA	common for All the channels	-	6 interrupt lines use six IRQs	50-pin Header	○	○	○	F-13	PIO-144W(PC)

ISA BUS Series Selection Guide

Digital I/O Boards

Analog I/O Boards

Communication Boards

Counter & Motor Controller

Isolation	Digital I/O	Analog Output	Connector	Software			Page	Name
				ACX-PAC(W32)	API-PAC(W32)	DDE SERVER(W32)		
-	4 TTL inputs, 4 TTL outputs	1	37-pin D-type	○	○	○	F-22	AD12-16(PC)EH
-	4 TTL inputs, 4 TTL outputs	1	37-pin D-type	○	○	○	F-22	AD12-16U(PC)EH
-	4 TTL inputs, 4 TTL outputs	1	37-pin D-type	○	○	○	F-23	AD16-16(PC)EH
-	4 TTL inputs, 4 TTL outputs	1	37-pin D-type	○	○	○	F-23	AD16-16U(PC)EH
-	Input:1 Output:1	-	37-pin D-type	○	○	○	F-26	AD12-16(PC)
-	Input:3 Output:4	-	37-pin D-type	○	○	○	F-26	AD12-8LT(PC)
-	Input:8 Output:8	-	37-pin D-type	○	○	○	F-27	AD12-16LG(PC)
Bus	Input:2 Output:4	-	37-pin D-type	○	○	○	F-27	AD12-16(PC)
BUS, Channel	Input:2 Output:4	-	37-pin D-type	○	○	○	F-27	AD12-8CL(PC)H
-	Input:1 Output:1	-	37-pin D-type	○	○	○	F-28	DA12-4(PC)
-	24 Bi-directional	-	37-pin D-type	○	○	○	F-28	DA12-6LC(PC)
-	4 TTL inputs, 4 TTL outputs	-	37-pin D-type	○	○	○	F-28	DA12-8L(PC)
Bus	Input:2 Output:4	-	37-pin D-type	○	○	○	F-29	DA12-4C(PC)
Bus	Input:2 Output:4	-	37-pin D-type	○	○	○	F-29	DA12-8C(PC)
-	-	-	37-pin D-type	○	○	○	F-29	DA16-4D(PC)

Name	Channels	Counting system				Max. Count value (Bits)	Input circuit		Response frequency		Interrupt event		Expansion function		Software			Page
		UP	DOWN	Single-phase	Two-phase		One-isolated Input	TTL level Input	One-isolated Input	TTL level Input	Time-up	Filter	Count matches	ACX-PAC(W32)	API-PAC(W32)	DDE SERVER(W32)		
CNT24-4(PC)	4	○	○	○	○	24	○	○	500kHz	1MHz	○	○	○	○	○	○	F-39	
CNT16-32S(PC)	32	○	○	○	○	16	○	○	200Hz	○	○	○	○	○	○	○	F-39	

Name	Output type	Signal format		Pulse rate [pps]	Encoder Input	Limit switches			Digital I/O	Software			Page
		2pulse	Common pulse			+LIM/-LIM	Slow-down	Original		ACX-PAC(W32)	API-PAC(W32)	DDE SERVER(W32)	
SMC-3(PC)	Open collector output	○	○	92-6M		○	○	○	Input : 2ch Output : 2ch		○		F-39
STP-2M(PC)	Open collector output	○	○	1-8191(x1) 30-245730(x 30)	○	○	○	○	Input : 8 Output : 8				F-40

Digital I/O Boards

F-04

ISA BUS SERIES

Opto-Isolated Digital Input Board PI-32L(PC)V



SPECIFICATIONS

Inputs channels	32
Output channels	-
I/O Circuit	
Signal level	+12 - 24VDC
Internal power	-
Input specification	
Input type	Opto-Isolated Input (for current sinking output) (Negative logic)
Interrupt	Usable 2 interrupt lines simultaneously from IRQ 3-7,9,12,14 and 15
Input resistance	3KΩ
Output specification	
Output type	-
Output rating	-
Expansion function	-

FEATURES

- 32 opto-isolated digital inputs
- 1000Vrms voltage isolation
- Reverse current protection for all inputs

Response time (Max.)	1msec
Maximum distance	50m
I/O address	4 port occupation
Power consumption (Max.)	+5VDC 50mA
Bus/Dimension (mm)	AT Bus / 163.0(L)x122.0(H)
Connector	37-pin female D-type
Option	
Software	ACX-PAC(W32)BP, ACX-PAC(W32)AP, API-PAC(W32), DDE SERVER(W32)
Accessories	DTP-3(PC), DTP-4(PC), EPD-37*1, CM-32(PC), CM-32(PC)E*1
Cables/Connector	PCA37P, PCB37P, PCA37PS, PCB37PS

*1: Option cable of PCB37P or PCB37PS is required.

Negative-Common Opto-Isolated Digital Input Board PI-32RL(PC)



SPECIFICATIONS

Inputs channels	32
Output channels	-
I/O Circuit	
Signal level	+12 - 24VDC
Internal power	-
Input specification	
Input type	Opto-Isolated Input (for current sourcing output)
Interrupt	Usable 2 interrupt lines simultaneously from IRQ 3-7,9,12,14 and 15
Input resistance	3KΩ
Output specification	
Output type	-
Output rating	-
Expansion function	-

FEATURES

- 32 opto-isolated digital inputs
- 16 channels share a negative common
- Reverse current protection for all the inputs

Response time (Max.)	1msec
Maximum distance	50m
I/O address	4 port occupation
Power consumption (Max.)	+5VDC 300mA
Bus/Dimension (mm)	AT Bus / 163.0(L)x122.0(H)
Connector	37-pin female D-type
Option	
Software	ACX-PAC(W32)BP, ACX-PAC(W32)AP, API-PAC(W32), SUPPORT-PAC(PC)601, DDE SERVER(W32)
Accessories	DTP-3(PC), DTP-4(PC), EPD-37*1
Cables/Connector	PCA37P, PCB37P, PCA37PS, PCB37PS

*1: Option cable of PCB37P or PCB37PS is required.

Opto-Isolated Digital Input Board with On-Board 12V Power Supply PI-32B(PC)H



SPECIFICATIONS

Inputs channels	32
Output channels	-
I/O Circuit	
Signal level	+12 - 24VDC
Internal power	DC12V 250mA
Input specification	
Input type	Opto-Isolated Input (for current sinking output) (Negative logic)
Interrupt	Usable 2 interrupt lines simultaneously from IRQ 3-7,9,12,14 and 15
Input resistance	3KΩ
Output specification	
Output type	-
Output rating	-
Expansion function	-

FEATURES

- 32 opto-isolated digital inputs
- On board isolated power supply, Internal/external power supply-jumper selectable
- Reverse current protection for all the inputs

Response time (Max.)	1msec
Maximum distance	30m
I/O address	4 port occupation
Power consumption (Max.)	+5VDC 50mA(External power) +5VDC 800mA(On board power)
Bus/Dimension (mm)	AT Bus /163.0(L)x122.0(H)
Connector	37-pin female D-type
Option	
Software	ACX-PAC(W32)BP, ACX-PAC(W32)AP, API-PAC(W32), SUPPORT-PAC(PC)601, DDE SERVER(W32)
Accessories	DTP-3(PC), DTP-4(PC), EPD-37*1, CM-32(PC)E*1, CM-32(PC)
Cables/Connector	PCA37P, PCB37P, PCA37PS, PCB37PS

*1: Option cable of PCB37P or PCB37PS is required.

ISA BUS Series Selection Guide

Digital I/O Boards

Analog I/O Boards

Communication Boards

Counter & Motor Controller

TTL Digital Input Board PI-32T(PC)H

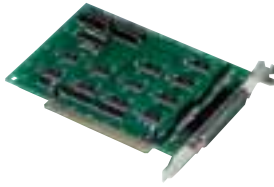

Input 32 Non Isolated CE

- FEATURES**
- 32 TTL compatible digital inputs
 - High speed response
 - Two interrupt lines to support real time applications

SPECIFICATIONS

Inputs channels	32
Output channels	-
I/O Circuit	
Signal level	+5VDC
Internal power	-
Input specification	
Input type	TTL level Input
Interrupt	Usable 2 interrupt lines simultaneously from IRQ 3-7,9
Input resistor	10KΩ
Output specification	
Output type	-
Output rating	-
Expansion function	-
Response time (Max.)	200nsec

Maximum distance	1.5m
I/O address	4 port occupation
Power consumption (Max.)	+5VDC 420mA
Bus/ Dimension (mm)	XT Bus /143.0(L)x107.0(H)
Connector	37-pin female D-type
Option	
Software	ACX-PAC(W32)BP, ACX-PAC(W32)AP, API-PAC(W32), SUPPORT-PAC(PC)601, DDE SERVER(W32)
Accessories	DTP-3(PC), DTP-4(PC), EPD-37** ¹ , CM-32(PC), CM-32(PC)E** ¹
Cables/Connector	PCA37P, PCB37P, PCA37PS, PCB37PS

*1: Option cable of PCB37P or PCB37PS is required.

Isolated TTL Digital Input Board with On-Board 5V Power Supply PI-32TB(PC)

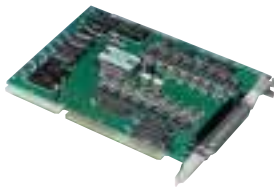

Input 32 Isolated Power on board CE

- FEATURES**
- 32 opto-isolated TTL digital inputs
 - On board isolated power supply
 - Internal/external power supply-jumper selectable

SPECIFICATIONS

Inputs channels	32
Output channels	-
I/O Circuit	
Signal level	+5VDC
Internal power	+5VDC 250mA
Input specification	
Input type	Opto-Isolated TTL Input (Negative logic)
Interrupt	Usable 2 interrupt lines simultaneously from IRQ 3-7,9
Input resistance	1.1KΩ
Output specification	
Output type	-
Output rating	-
Expansion function	-
Response time (Max.)	1 μsec

Maximum distance	5m
I/O address	4 port occupation
Power consumption (Max.)	+5VDC 550mA(External power) +5VDC 1010mA(On board power)
Bus/ Dimension (mm)	AT Bus /163.0(L)x122.0(H)
Connector	37-pin female D-type
Option	
Software	ACX-PAC(W32)BP, ACX-PAC(W32)AP, API-PAC(W32), SUPPORT-PAC(PC)601, DDE SERVER(W32)
Accessories	DTP-3(PC), DTP-4(PC), EPD-37** ¹ , CM-32(PC)E** ¹ , CM-32(PC)
Cables/Connector	PCA37P, PCB37P, PCA37PS, PCB37PS

*1: Option cable of PCB37P or PCB37PS is required.

Opto-Isolated Digital Input Board PI-64L(PC)



Input 64 Isolated CE

- FEATURES**
- 64 opto-isolated digital inputs
 - External power supply requirement: +12-24VDC
 - Reverse current protection for all inputs

SPECIFICATIONS

Inputs channels	64
Output channels	-
I/O Circuit	
Signal level	+12 - 24VDC
Internal power	-
Input specification	
Input type	Opto-Isolated Input (for current sinking output) (Negative logic)
Interrupt	Usable 2 interrupt lines simultaneously from IRQ 3-7, 9, 12,14 and 15
Input resistance	3KΩ
Output specification	
Output type	-
Output rating	-
Expansion function	Yes
Response time (Max.)	1msec
Maximum distance	50m

I/O address	Any 8-byte boundary (normal) Any 16-byte boundary (optional)
Power consumption (Max.)	+5VDC 100mA
Bus/ Dimension (mm)	AT Bus /163.0(L)x122.0(H)
Connector	96-pin half pitch connector (male)
Option	
Software	ACX-PAC(W32)BP, ACX-PAC(W32)AP, API-PAC(W32), SUPPORT-PAC(PC)602, DDE SERVER(W32)
Accessories	DTP-3(PC)** ¹ , DTP-4(PC)** ¹ , DTP-64(PC)** ² , EPD-96** ² , CCB-96** ² , CM-32(PC)** ¹ , CM-64(PC)E** ²
Cables/ Connector	PCA96P, PCB96P, PCB96W, PCA96PS, PCB96PS, PCB96WS

*1: Option cable of PCB96W or PCB96WS is required.

*2: Option cable of PCB96P or PCB96PS is required.

F-05

ISA BUS SERIES

ISA BUS Series Selection Guide

Digital I/O Boards

Analog I/O Boards

Communication Boards

Counter & Motor Controller

TTL Digital Input Board PI-64T(PC)



SPECIFICATIONS

Inputs channels	64
Output channels	-
I/O Circuit	
Signal level	+5VDC
Internal power	-
Input specification	
Input type	TTL level Input
Interrupt	Four interrupt lines use four IRQs, IRQ 3-7, 9, 12,14 and 15
Input resistor	10KΩ
Output specification	
Output type	-
Output rating	-
Expansion function	Yes
Response time (Max.)	200nsec
Maximum distance	1.5m

FEATURES

- 64 TTL compatible digital I/O
- High speed response
- Four interrupt lines to support real time applications

I/O address	Any 8-byte boundary (normal) Any 16-byte boundary (optional)
Power consumption (Max.)	+5VDC 200mA
Bus/Dimension (mm)	AT Bus /163.0(L)x122.0(H)
Connector	96-pin half pitch connector (male)
Option	
Software	ACX-PAC(W32)BP, ACX-PAC(W32)AP, API-PAC(W32), SUPPORT-PAC(PC)602, DDE SERVER(W32)
Accessories	DTP-3(PC)*1, DTP-4(PC)*1, DTP-64(PC)*2, EPD-96*2, CCB-96*2, CM-32(PC)*1, CM-64(PC)E*2
Cables/Connector	PCA96P, PCB96P, PCB96W, PCA96PS, PCB96PS, PCB96WS

*1: Option cable of PCB96W or PCB96WS is required.
*2: Option cable of PCB96P or PCB96PS is required.

Opto-Isolated Digital Output Board PO-32L(PC)V



SPECIFICATIONS

Inputs channels	-
Output channels	32
I/O Circuit	
Signal level	+12 - 24VDC
Internal power	-
Input specification	
Input type	-
Interrupt	-
Input resistance	-
Output specification	
Output type	Opto-Isolated Open Collector Output (current sinking type) (Negative logic)
Output rating	+35VDC 100mA
Expansion function	-

FEATURES

- 32 opto-isolated digital outputs
- Signal level: +12-24VDC
- High sink current: 200mA max. per channel, 2A max. per group

Response time (Max.)	1msec
Maximum distance	50m
I/O address	4 port occupation
Power consumption (Max.)	+5VDC 50mA
Bus/Dimension (mm)	AT Bus /163.0(L)x122.0(H)
Connector	37-pin female D-type
Option	
Software	ACX-PAC(W32)BP, ACX-PAC(W32)AP, API-PAC(W32), SUPPORT-PAC(PC)601, DDE SERVER(W32)
Accessories	DTP-3(PC), DTP-4(PC), EPD-37*1, CM-32(PC), CM-32(PC)E*1
Cables/Connector	PCA37P, PCB37P, PCA37PS, PCB37PS

*1: Option cable of PCB37P or PCB37PS is required.

Negative-Common Opto-Isolated Digital Output Board PO-32RL(PC)



SPECIFICATIONS

Inputs channels	-
Output channels	32
I/O Circuit	
Signal level	+12 - 24VDC
Internal power	-
Input specification	
Input type	-
Interrupt	-
Input resistance	-
Output specification	
Output type	Opto-Isolated Output (current sourcing type)
Output rating	+35VDC 150mA
Expansion function	-

FEATURES

- 32 opto-isolated digital outputs
- Loads are connected between outputs and the negative common of the external power supply
- Signal level: +12-24VDC

Response time (Max.)	1msec
Maximum distance	50m
I/O address	4 port occupation
Power consumption (Max.)	+5VDC 300mA
Bus/Dimension (mm)	AT Bus /163.0(L)x122.0(H)
Connector	37-pin female D-type
Option	
Software	ACX-PAC(W32)BP, ACX-PAC(W32)AP, API-PAC(W32), SUPPORT-PAC(PC)601, DDE SERVER(W32)
Accessories	DTP-3(PC), DTP-4(PC), EPD-37*1
Cables/Connector	PCA37P, PCB37P, PCA37PS, PCB37PS

*1: Option cable of PCB37P or PCB37PS is required.

Opto-Isolated Digital Output Board with On-Board 12V Power Supply PO-32B(PC)H



Output 32 Isolated Power on board CE

FEATURES

- 32 opto-isolated digital outputs
- Signal level: +12-24VDC
- On board isolated power supply

SPECIFICATIONS

Inputs channels	-
Output channels	32
I/O Circuit	
Signal level	+12 - 24VDC
Internal power	DC12V 250mA
Input specification	
Input type	-
Interrupt	-
Input resistance	-
Output specification	
Output type	Opto-Isolated Open Collector Output (current sinking type) (Negative logic)
Output rating	+35VDC 100mA
Expansion function	-

Response time (Max.)	1msec
Maximum distance	30m
I/O address	4 port occupation
Power consumption (Max.)	+5VDC 50mA(External power) +5VDC 800mA(On board power)
Bus/ Dimension (mm)	AT Bus /163.0(L)x122.0(H)
Connector	37-pin female D-type
Option	
Software	ACX-PAC(W32)BP, ACX-PAC(W32)AP, API-PAC(W32), SUPPORT-PAC(PC)601, DDE SERVER(W32)
Accessories	DTP-3(PC), DTP-4(PC), EPD-37*1, CM-32(PC)E*1, CM-32(PC)
Cables/Connector	PCA37P, PCB37P, PCA37PS, PCB37PS

*1: Option cable of PCB37P or PCB37PS is required.

TTL-Level Digital Output Board PO-32T(PC)H

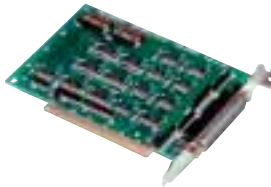

Output 32 Non Isolated CE

FEATURES

- 32 TTL compatible digital outputs
- TTL compatible 32ch digital outputs (High sink current outputs : 40mA max.)
- High-speed response

SPECIFICATIONS

Inputs channels	-
Output channels	32
I/O Circuit	
Signal level	+5VDC
Internal power	-
Input specification	
Input type	-
Interrupt	-
Input resistance	-
Output specification	
Output type	Open collector outputs (negative logic), TTL
Output rating	+5VDC 40mA
Expansion function	-
Response time (Max.)	200nsec

Maximum distance	1.5m
I/O address	4 port occupation
Power consumption (Max.)	+5VDC 550mA
Bus/ Dimension (mm)	XT Bus /143.0(L)x107.0(H)
Connector	37-pin female D-type
Option	
Software	ACX-PAC(W32)BP, ACX-PAC(W32)AP, API-PAC(W32), SUPPORT-PAC(PC)601, DDE SERVER(W32)
Accessories	DTP-3(PC), DTP-4(PC), EPD-37*1, CM-32(PC), CM-32(PC)E*1
Cables/Connector	PCA37P, PCB37P, PCA37PS, PCB37PS

*1: Option cable of PCB37P or PCB37PS is required.

High speed Opto-Isolated TTL Digital Output Board with On-Board 5V Power Supply PO-32TB(PC)

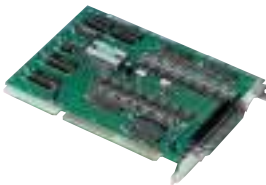

Output 32 Isolated Power on board CE

FEATURES

- 32 opto-isolated TTL digital outputs
- On board isolated power supply
- High speed response

SPECIFICATIONS

Inputs channels	-
Output channels	32
I/O Circuit	
Signal level	+5VDC
Internal power	+5VDC 250mA
Input specification	
Input type	-
Interrupt	-
Input resistance	-
Output specification	
Output type	Opto-isolated TTL (negative logic)
Output rating	+5VDC 6.4mA
Expansion function	-
Response time (Max.)	1 μsec

Maximum distance	5m
I/O address	4 port occupation
Power consumption (Max.)	+5VDC 440mA(External power) +5VDC 900mA(On board power)
Bus/ Dimension (mm)	AT Bus /163.0(L)x122.0(H)
Connector	37-pin female D-type
Option	
Software	ACX-PAC(W32)BP, ACX-PAC(W32)AP, API-PAC(W32), SUPPORT-PAC(PC)601, DDE SERVER(W32)
Accessories	DTP-3(PC), DTP-4(PC), EPD-37*1, CM-32(PC)E*1, CM-32(PC)
Cables/Connector	PCA37P, PCB37P, PCA37PS, PCB37PS

*1: Option cable of PCB37P or PCB37PS is required.

F-07

ISA BUS SERIES

ISA BUS Series Selection Guide

Digital I/O Boards

Analog I/O Boards

Communication Boards

Counter & Motor Controller

Opto-Isolated Digital Output PO-64L(PC)

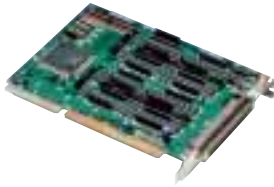

Output 64 Isolated CE

SPECIFICATIONS

Inputs channels	-
Output channels	64
I/O Circuit	
Signal level	+12 - 24VDC
Internal power	-
Input specification	
Input type	-
Interrupt	-
Input resistance	-
Output specification	
Output type	Opto-Isolated Open Collector Output (current sinking type) (Negative logic)
Output rating	+35VDC 100mA
Expansion function	Yes
Response time (Max.)	1msec
Maximum distance	50m

FEATURES

- 64 opto-isolated digital outputs
- Signal level: +12-24VDC
- High sink current: DC35, 100mA max. per channel

I/O address	Any 8-byte boundary (normal) Any 16-byte boundary (optional)
Power consumption (Max.)	+5VDC 250mA
Bus/Dimension (mm)	AT Bus /163.0(L)x122.0(H)
Connector	96-pin half pitch Connector (male)
Option	
Software	ACX-PAC(W32)BP, ACX-PAC(W32)AP, API-PAC(W32), SUPPORT-PAC(PC)602, DDE SERVER(W32)
Accessories	DTP-3(PC)*1, DTP-4(PC)*1, DTP-64(PC)*2, EPD-96*2, CCB-96*2, CM-32(PC)*1, CM-64(PC)E*2
Cables/Connector	PCA96P, PCB96P, PCB96W, PCA96PS, PCB96PS, PCB96WS

*1: Option cable of PCB96W or PCB96WS is required.
*2: Option cable of PCB96P or PCB96PS is required.

TTL-Level Digital Output Board PO-64T(PC)

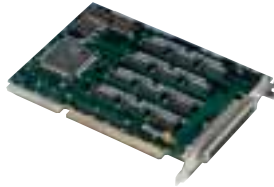

Output 64 Non Isolated CE

SPECIFICATIONS

Inputs channels	-
Output channels	64
I/O Circuit	
Signal level	+5VDC
Internal power	-
Input specification	
Input type	-
Interrupt	-
Input resistance	-
Output specification	
Output type	Open collector outputs
Output rating	+30VDC 40mA
Expansion function	Yes
Response time (Max.)	200nsec
Maximum distance	1.5m
I/O address	Any 8-byte boundary (normal) Any 16-byte boundary (optional)

FEATURES

- 64 TTL compatible digital outputs
- High sink current digital outputs: 40mA max.

Power consumption (Max.)	+5VDC 250mA
Bus/Dimension (mm)	AT Bus /163.0(L)x122.0(H)
Connector	96-pin half pitch Connector (male)
Option	
Software	ACX-PAC(W32)BP, ACX-PAC(W32)AP, API-PAC(W32), SUPPORT-PAC(PC)602, DDE SERVER(W32)
Accessories	DTP-3(PC)*1, DTP-4(PC)*1, DTP-64(PC)*2, EPD-96*2, CCB-96*2, CM-32(PC)*1, CM-64(PC)E*2
Cables/Connector	PCA96P, PCB96P, PCB96W, PCA96PS, PCB96PS, PCB96WS

*1: Option cable of PCB96W or PCB96WS is required.
*2: Option cable of PCB96P or PCB96PS is required.

Opto-Isolated Digital I/O Board PIO-16/16L(PC)V



Input 16 Output 16 Isolated CE

SPECIFICATIONS

Inputs channels	16
Output channels	16
I/O Circuit	
Signal level	+12 - 24VDC
Internal power	-
Input specification	
Input type	Opto-Isolated Input (for current sinking output) (Negative logic)
Interrupt	Two interrupt lines use two IRQs, IRQ 3-7, 9, 12, 14 and 15
Input resistance	3KΩ
Output specification	
Output type	Opto-Isolated Open Collector Output (current sinking type) (Negative logic)
Output rating	+35VDC 100mA
Expansion function	-

FEATURES

- 32 opto-isolated inputs and outputs
- Signal level: +12-24VDC
- High sink current: 200mA max. per channel

Response time (Max.)	1msec
Maximum distance	50m
I/O address	Any 2-byte boundary
Power consumption (Max.)	+5VDC 50mA
Bus/Dimension (mm)	AT Bus /163.0(L)x122.0(H)
Connector	37-pin female D-type
Option	
Software	ACX-PAC(W32)BP, ACX-PAC(W32)AP, API-PAC(W32), SUPPORT-PAC(PC)601, DDE SERVER(W32)
Accessories	DTP-3(PC), DTP-4(PC), EPD-37*1, CM-32(PC), CM-32(PC)E*1
Cables/Connector	PCA37P, PCB37P, PCA37PS, PCB37PS

*1: Option cable of PCB37P or PCB37PS is required.

Negative-Common Opto-Isolated Digital I/O Board PIO-16/16RL(PC)

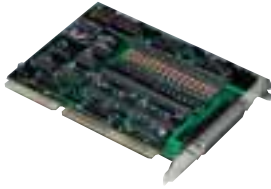

Input 16 Output 16 Isolated CE

- FEATURES**
- 32 opto-isolated inputs and outputs
 - Signal level: +12-24VDC
 - Reverse current protection for all inputs

SPECIFICATIONS

Inputs channels	16
Output channels	16
I/O Circuit	
Signal level	+12 - 24VDC
Internal power	-
Input specification	
Input type	Opto-Isolated Input (for current sourcing output)
Interrupt	Usable 2 interrupt lines simultaneously from IRQ 3-7,9,12,14 and 15
Input resistance	3KΩ
Output specification	
Output type	Opto-Isolated Output (current sourcing type)
Output rating	+35VDC 150mA
Expansion function	-

Response time (Max.)	1msec
Maximum distance	50m
I/O address	Any 2-byte boundary
Power consumption (Max.)	+5VDC 350mA
Bus/Dimension (mm)	AT Bus /163.0(L)x122.0(H)
Connector	37-pin female D-type
Option	
Software	ACX-PAC(W32)BP, ACX-PAC(W32)AP, API-PAC(W32), SUPPORT-PAC(PC)601, DDE SERVER(W32)
Accessories	DTP-3(PC), DTP-4(PC), EPD-37**
Cables/Connector	PCA37P, PCB37P, PCA37PS, PCB37PS

*1: Option cable of PCB37P or PCB37PS is required.

Opto-Isolated Digital I/O Board with On-board 12V Power Supply PIO-16/16B(PC)H



Input 16 Output 16 Isolated Power on board CE

- FEATURES**
- 32 opto-isolated inputs and outputs
 - On board isolated power supply
 - Internal/external power supply - jumper selectable

SPECIFICATIONS

Inputs channels	16
Output channels	16
I/O Circuit	
Signal level	+12 - 24VDC
Internal power	DC12V 250mA
Input specification	
Input type	Opto-Isolated Input (for current sinking output) (Negative logic)
Interrupt	Usable 2 interrupt lines simultaneously from IRQ 3-7,9,12,14 and 15
Input resistance	3KΩ
Output specification	
Output type	Opto-Isolated Open Collector Output (current sinking type) (Negative logic)
Output rating	+35VDC 100mA
Expansion function	-

Response time (Max.)	1msec
Maximum distance	30m
I/O address	Any 2-byte boundary
Power consumption (Max.)	+5VDC 50mA(External power) +5VDC 800mA(On board power)
Bus/Dimension (mm)	AT Bus /163.0(L)x122.0(H)
Connector	37-pin female D-type
Option	
Software	ACX-PAC(W32)BP, ACX-PAC(W32)AP, API-PAC(W32), SUPPORT-PAC(PC)601, DDE SERVER(W32)
Accessories	DTP-3(PC), DTP-4(PC), EPD-37**, CM-32(PC)E *1, CM-32(PC)
Cables/Connector	PCA37P, PCB37P, PCA37PS, PCB37PS

*1: Option cable of PCB37P or PCB37PS is required.

TTL-Level Digital I/O Board PIO-16/16T(PC)H

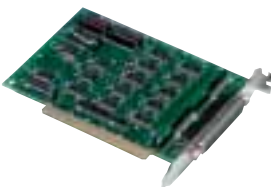

Input 16 Output 16 Non Isolated CE

- FEATURES**
- 32 TTL compatible digital inputs and outputs
 - High sink current digital outputs: 40mA max.
 - 2 interrupt lines to support real time applications

SPECIFICATIONS

Inputs channels	16
Output channels	16
I/O Circuit	
Signal level	+5VDC
Internal power	-
Input specification	
Input type	TTL level Input
Interrupt	Usable 2 interrupt lines simultaneously from IRQ 3-7,9
Input resistor	10KΩ
Output specification	
Output type	Open collector outputs (negative logic), TTL
Output rating	+5VDC 40mA
Expansion function	-
Response time (Max.)	200nsec

Maximum distance	1.5m
I/O address	Any 2-byte boundary
Power consumption (Max.)	+5VDC 550mA
Bus/Dimension (mm)	XT Bus /143.0(L)x107.0(H)
Connector	37-pin female D-type
Option	
Software	ACX-PAC(W32)BP, ACX-PAC(W32)AP, API-PAC(W32), SUPPORT-PAC(PC)601, DDE SERVER(W32)
Accessories	DTP-3(PC), DTP-4(PC), EPD-37**, CM-32(PC), CM-32(PC)E*1
Cables/Connector	PCA37P, PCB37P, PCA37PS, PCB37PS

*1: Option cable of PCB37P or PCB37PS is required.

F-09

ISA BUS SERIES

ISA BUS Series Selection Guide

Digital I/O Boards

Analog I/O Boards

Communication Boards

Counter & Motor Controller

Opto-Isolated TTL Digital I/O Board with On-Board 5V Power Supply PIO-16/16TB(PC)

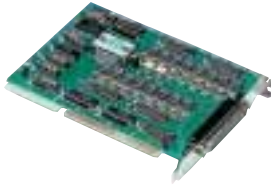

Input 16 Output 16 Isolated Power on board CE

SPECIFICATIONS

Inputs channels	16
Output channels	16
I/O Circuit	
Signal level	+5VDC
Internal power	+5VDC 250mA
Input specification	
Input type	Opto-Isolated TTL Input (Negative logic)
Interrupt	Usable 2 interrupt lines simultaneously from IRQ 3-7,9,12,14 and 15
Input resistance	1.1KΩ
Output specification	
Output type	Opto-isolated TTL (negative logic)
Output rating	+5VDC 6.4mA
Expansion function	-

FEATURES

- 32 opto-isolated TTL digital inputs and outputs
- On board isolated power supply
- High-speed response

Response time (Max.)	1 μsec
Maximum distance	5m
I/O address	Any 2-byte boundary
Power consumption (Max.)	+5VDC 550mA(External power) +5VDC 1010mA(On board power)
Bus/Dimension (mm)	AT Bus /163.0(L)x122.0(H)
Connector	37-pin female D-type
Option	
Software	ACX-PAC(W32)BP, ACX-PAC(W32)AP, API-PAC(W32), SUPPORT-PAC(PC)601, DDE SERVER(W32)
Accessories	DTP-3(PC), DTP-4(PC), EPD-37*1, CM-32(PC)E*1, CM-32(PC)
Cables/Connector	PCA37P, PCB37P, PCA37PS, PCB37PS

*1: Option cable of PCB37P or PCB37PS is required.

Opto-Isolated Digital I/O Board PIO-24/24(PC)

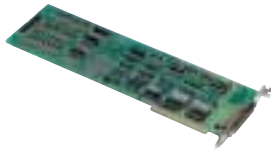

Input 24 Output 24 Isolated

SPECIFICATIONS

Inputs channels	24
Output channels	24
I/O Circuit	
Signal level	+12 - 24VDC
Internal power	-
Input specification	
Input type	Opto-Isolated Input (for current sinking output) (Negative logic)
Interrupt	Usable 4 interrupt lines simultaneously from IRQ 3-7,9
Input resistance	2KΩ
Output specification	
Output type	Opto-Isolated Open Collector Output (current sinking type) (Negative logic)
Output rating	+35VDC 200mA
Expansion function	-
Response time (Max.)	1msec

FEATURES

- 48 opto-isolated digital inputs and outputs
- Signal level: +12-24VDC
- 4 interrupt lines

Maximum distance	50m
I/O address	4 port occupation
Power consumption (Max.)	+5VDC 750mA
Bus/Dimension (mm)	XT Bus /340.5(L)x107.0(H)
Connector	Input : 30-pin header (male) Output :37-pin female D-type
Option	
Software	SUPPORT-PAC(PC)601
Accessories	DTP-3(PC), DTP-4(PC), EPD-37*1
Cables/Connector	PCA37P, PCB37P, PCA37PS, PCB37PS, DT/O, DT/B2

**Digital Input cable Attached
*1: Option cable of PCB37P or PCB37PS is required.

Opto-Isolated Digital I/O Board PIO-32/32L(PC)



Input 32 Output 32 Isolated CE

SPECIFICATIONS

Inputs channels	32
Output channels	32
I/O Circuit	
Signal level	+12 - 24VDC
Internal power	-
Input specification	
Input type	Opto-Isolated Input (for current sinking output) (Negative logic)
Interrupt	Usable 4 interrupt lines simultaneously from IRQ 3-7,9,12,14 and 15
Input resistance	3KΩ
Output specification	
Output type	Opto-Isolated Open Collector Output (current sinking type) (Negative logic)
Output rating	+35VDC 100mA
Expansion function	Yes
Response time (Max.)	1msec
Maximum distance	50m

FEATURES

- 64 opto-isolated digital inputs/outputs
- External power supply requirement: +12-24VDC
- Up to 16 boards can be used in a system

I/O address	Any 4-byte boundary (normal) Any 16-byte boundary (optional)
Power consumption (Max.)	+5VDC 180mA
Bus/Dimension (mm)	AT Bus /163.0(L)x122.0(H)
Connector	96-pin half pitch Connector (male)
Option	
Software	ACX-PAC(W32)BP, ACX-PAC(W32)AP, API-PAC(W32), SUPPORT-PAC(PC)602, DDE SERVER(W32)
Accessories	DTP-3(PC)*1, DTP-4(PC)*1, DTP-64(PC)*2, EPD-96*2, CCB-96*2, CM-32(PC)*1, CM-64(PC)E*2
Cables/Connector	PCA96P, PCB96P, PCB96W, PCA96PS, PCB96PS, PCB96WS

*1: Option cable of PCB96W or PCB96WS is required.
*2: Option cable of PCB96P or PCB96PS is required.

Negative-Common Opto-Isolated Digital I/O Board PIO-32/32RL(PC)



Input 32 Output 32 Isolated CE

FEATURES

- 64 opto-isolated digital I/O
- Signal level: +12-24VDC
- High source current: 150mA max. per channel, 2A max. per group

SPECIFICATIONS

Inputs channels	32
Output channels	32
I/O Circuit	
Signal level	+12 - 24VDC
Internal power	-
Input specification	
Input type	Opto-Isolated Input (for current sourcing output)
Interrupt	Usable 2 interrupt lines simultaneously from IRQ 3-7,9,12,14 and 15
Input resistance	3KΩ
Output specification	
Output type	Opto-Isolated Output (current sourcing type)
Output rating	+35VDC 150mA
Expansion function	Yes
Response time (Max.)	1msec
Maximum distance	50m

I/O address	Any 4-byte boundary (normal) Any 16-byte boundary (optional)
Power consumption (Max.)	+5VDC 150mA
Bus/ Dimension (mm)	AT Bus /163.0(L)x122.0(H)
Connector	96-pin female half pitch (male)
Option	
Software	ACX-PAC(W32)BP, ACX-PAC(W32)AP, API-PAC(W32), SUPPORT-PAC(PC)602, DDE SERVER(W32)
Accessories	DTP-3(PC)*1, DTP-4(PC)*1, DTP-64(PC)*2, EPD-96*2
Cables/Connector	PCA96P, PCB96P, PCB96W, PCA96PS, PCB96PS, PCB96WS

*1: Option cable of PCB96W or PCB96WS is required.
*2: Option cable of PCB96P or PCB96PS is required.

TTL-Level Digital I/O Board PIO-32/32T(PC)

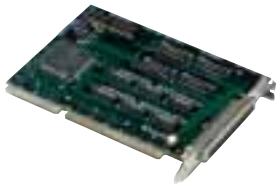

Input 32 Output 32 Non Isolated CE

FEATURES

- 64 TTL compatible digital I/Os
- High sink current digital outputs: 40mA max.
- 4 interrupt lines to support real time applications

SPECIFICATIONS

Inputs channels	32
Output channels	32
I/O Circuit	
Signal level	+5VDC
Internal power	-
Input specification	
Input type	TTL level Input
Interrupt	Usable 2 interrupt lines simultaneously from IRQ 3-7,9,12,14 and 15
Input resistance	10KΩ
Output specification	
Output type	Open collector outputs
Output rating	+30VDC 40mA
Expansion function	Yes
Response time (Max.)	200nsec
Maximum distance	1.5m

I/O address	Any 4-byte boundary (normal) Any 16-byte boundary (optional)
Power consumption (Max.)	+5VDC 250mA
Bus/ Dimension (mm)	AT Bus /163.0(L)x122.0(H)
Connector	96-pin female half pitch (male)
Option	
Software	ACX-PAC(W32)BP, ACX-PAC(W32)AP, API-PAC(W32), SUPPORT-PAC(PC)602, DDE SERVER(W32)
Accessories	DTP-3(PC)*1, DTP-4(PC)*1, DTP-64(PC)*2, EPD-96*2, CCB-96*2, CM-32(PC)*1, CM-64(PC)*2
Cables/ Connector	PCA96P, PCB96P, PCB96W, PCA96PS, PCB96PS, PCB96WS

*1: Option cable of PCB96W or PCB96WS is required.
*2: Option cable of PCB96P or PCB96PS is required.

High Current Drive Bi-Directional Digital I/O Board PIO-48D(PC)



Bi-direct 48 Non Isolated CE

FEATURES

- 48 TTL current drive bi-directional digital I/Os
- Emulate 8255 PPI mode 0
- 4 interrupt lines

SPECIFICATIONS

I/O channels	48
I/O Circuit	
Signal level	+5VDC
Internal power	-
Input specification	
Input type	TTL level Input
Interrupt	Usable 2 interrupt lines simultaneously from IRQ 3-7,9,12,14 and 15
Input resistance	10KΩ
Output specification	
Output type	TTL level Output with buffer
Output rating	+5VDC 24mA
Expansion function	-
Response time (Max.)	200nsec

Maximum distance	1.5m
I/O address	Any 8-byte boundary
Power consumption (Max.)	+5VDC 1.25A
Bus/ Dimension (mm)	AT Bus /163.0(L)x122.0(H)
Connector	50-pin header (male) x 2
Option	
Software	ACX-PAC(W32)BP, ACX-PAC(W32)AP, API-PAC(W32), SUPPORT-PAC(PC)603, DDE SERVER(W32)
Accessories	STP-50H(98), SCP-50H(98), PSD-50(98)J
Cables/Connector	PCA50J

Bi-Directional TTL Digital I/O Board PIO-48W(PC)



Bi-direct
48
Non
Isolated

■ SPECIFICATIONS

No. of channels	48
I/O Circuit	
Signal level	+5VDC
Internal power	-
Input specification	
Input type	TTL level Input
Interrupt	Usable 4 interrupt lines simultaneously from IRQ 3-7,9
Input resistance	10KΩ
Output specification	
Output type	TTL level Output
Output rating	+5VDC 1mA
Expansion function	-
Response time (Max.)	200nsec
Maximum distance	1.5m

FEATURES

- 48 bi-directional TTL digital I/Os
- Two 8255 PPIs on board
- 8255 PPI mode 0 - mode 2

I/O address	Any 16-byte boundary
Power consumption (Max.)	+5VDC 430mA
Bus/Dimension (mm)	XT Bus /187.0(L)x107.0(H)
Connector	37-pin female D-type, 30-pin header (male)
Option	
Software	ACX-PAC(W32)BP, ACX-PAC(W32)AP, API-PAC(W32), SUPPORT-PAC(PC)603, DDE SERVER(W32)
Accessories	DTP-3(PC), DTP-4(PC), EPD-37**
Cables/Connector	PCA37P, PCB37P, PCA37PS, PCB37PS, DT/O, DT/B2

*1: Option cable of PCB37P or PCB37PS is required.

Bi-Directional TTL Digital I/O Board PIO-96W(PC)

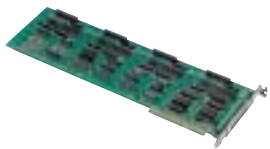

Bi-direct
96
Non
Isolated

■ SPECIFICATIONS

No. of channels	96
I/O Circuit	
Signal level	+5VDC
Internal power	-
Input specification	
Input type	TTL level Input
Interrupt	1 interrupt line
Input resistance	20KΩ
Output specification	
Output type	TTL level Output
Output rating	+5VDC 1mA
Expansion function	-
Response time (Max.)	200nsec
Maximum distance	1.5m

FEATURES

- 96 bi-directional TTL digital I/Os
- Four 8255 PPIs on board
- 8255 PPI mode 0 - mode 2

I/O address	Any 32-byte boundary
Power consumption (Max.)	+5VDC 450mA
Bus/Dimension (mm)	XT Bus /340.5(L)x107.0(H)
Connector	30-pin header Connector x 4
Option	
Software	ACX-PAC(W32)BP, ACX-PAC(W32)AP, API-PAC(W32), SUPPORT-PAC(PC)603, DDE SERVER(W32)
Accessories	DTP-3(PC)*1, DTP-4(PC)*1
Cables/Connector	PCA37P*, PCB37P*, PCA37PS*, PCB37PS*, DT/O, DT/B2

*1: Option cable of DT/B2 is required.

High Current Drive Bi-Directional Digital I/O Board PIO-120D(PC)

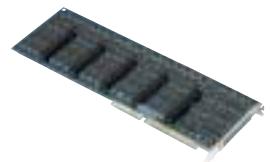

Bi-direct
120
Non
Isolated
CE

■ SPECIFICATIONS

No. of channels	120
I/O Circuit	
Signal level	+5VDC
Internal power	-
Input specification	
Input type	TTL level Input
Interrupt	1 interrupt line
Input resistance	10KΩ
Output specification	
Output type	TTL level Output with buffer
Output rating	+5VDC 24mA
Expansion function	-
Response time (Max.)	200nsec

FEATURES

- 120 TTL high current drive bi-directional digital I/Os
- Enhanced interrupts-use only one IRQ
- Emulate 8255 PPI mode 0

Maximum distance	1.5m
I/O address	Any 32-byte boundary
Power consumption (Max.)	+5VDC 1.6A
Bus/Dimension (mm)	AT Bus /340.5(L)x122.0(H)
Connector	50-pin header x 5
Option	
Software	ACX-PAC(W32)BP, ACX-PAC(W32)AP, API-PAC(W32), SUPPORT-PAC(PC)603, DDE SERVER(W32)
Accessories	STP-50H(98), SCP-50H(98), PSD-50(98)J
Cables/Connector	PCA50J

Bi-Directional TTL Digital I/O Board PIO-144W(PC)

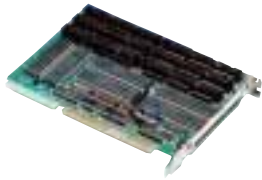

Bi-direct
144
Non
Isolated

FEATURES

- 144 bi-directional TTL digital I/Os
- Six 8255 PPIs on board
- 8255 PPI Mode 0 - Mode 2

SPECIFICATIONS

No. of channels	144
I/O Circuit	
Signal level	+5VDC
Internal power	-
Input specification	
Input type	TTL level Input
Interrupt	Usable 6 interrupt lines simultaneously from IRQ 3-7,9
Input resistance	22Ω
Output specification	
Output type	TTL level Output
Output rating	+5VDC 1mA
Expansion function	-
Response time (Max.)	200nsec

Maximum distance	1.5m
I/O address	Any 32-byte boundary
Power consumption (Max.)	+5VDC 330mA
Bus/ Dimension (mm)	AT Bus /163.0(L)x122.0(H)
Connector	50-pin header (male) x 6
Option	
Software	ACX-PAC(W32)BP, ACX-PAC(W32)AP, API-PAC(W32), SUPPORT-PAC(PC)603, DDE SERVER(W32)
Accessories	STP-50H(98), SCP-50H(98), PSD-50(98)J
Cables/Connector	PCA50J

Interrupt Controller Board IRT-16(PC)

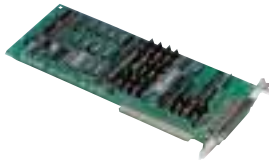

Input
16
Isolated
Non
Isolated

FEATURES

- 16 interrupt input points, gathered into two interrupt levels of eight points each
- Three interrupt levels available, two from external inputs and one from pacer clock
- Inputs-TTL-level or opto-isolated 12-24VDC

SPECIFICATIONS

Inputs channels	16
Output channels	-
I/O Circuit	
Signal level	+5VDC
Internal power	-
Input specification	
Input type	TTL-level or Opto-isolated 12-24VDC
Interrupt	8 signals generate 1 interrupt level. Board can connect 3 interrupt level.(2level from signals and time-up of timer)
Input resistance	Opto-isolated : 2KΩTTL-level : 10KΩ
Output specification	
Output type	-
Output rating	-
Expansion function	-

Response time (Max.)	Opto-isolated : 1msec TTL-level : 200nsec
Maximum distance	Opto-isolated : 50mTTL-level : 1.5m
I/O address	Any 2-byte boundary
Power consumption (Max.)	+5VDC 1000mA
Bus/ Dimension (mm)	XT Bus /252.0(L)x107.0(H)
Connector	37-pin female D-type
Option	
Software	-
Accessories	DTP-3(PC), DTP-4(PC), EPD-37*1, CM-32(PC)E*1, CM-32(PC)
Cables/ Connector	PCA37P, PCB-37P, PCA-37PS, PCB-37PS

*1: Option cable of PCB37P or PCB37PS is required.

Reed Relay Output Board RRY-32(PC)

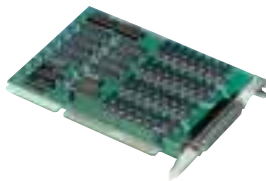

Output
32
Isolated
CE

FEATURES

- 32 reed relays
- Four groups of eight relay outputs
- Relay rating - 100V AC/DC 500mA

SPECIFICATIONS

Inputs channels	-
Output channels	32
Output type	Reed relay contact (1-make contact) output
Relay contact specifications	
Maximum power	10VA(AC), 10W(DC)
Maximum voltage	100V(AC), 100V(DC)
Maximum switching current	0.5A
Maximum current	1A
Contact resistance	150mΩ or less
Response time (Max.)	1msec
Life expectancy	1,000,000

I/O address	4 port occupation
Power consumption (Max.)	+5VDC 760mA
Bus/ Dimension (mm)	AT Bus /163.0(L)x122.0(H)
Connector	37-pin female D-type
Option	
Software	ACX-PAC(W32)BP, ACX-PAC(W32)AP, API-PAC(W32), SUPPORT-PAC(PC)601, DDE SERVER(W32)
Accessories	DTP-3(PC), DTP-4(PC), EPD-37*1
Cables/Connector	PCA37P, PCB37P, PCA37PS, PCB37PS

*1: Option cable of PCB37P or PCB37PS is required.

Photo MOS Relay Output Board PRY-32(PC)



Output
32
Isolated
CE

FEATURES

- Output type: Photo MOS relay (SPST)
- Relays: NEC PFA122A Photo MOS relays
- Relay rating: Withstand voltage 100V (AC/DC) max.

SPECIFICATIONS

Inputs channels	-
Output channels	32
Output type	Photo MOS relays (8 channels with the common)
Relay contact specification	
Relay rating	100VA/DC
Drive current	250mA max. per channel, 1A max. per common (8 channels with the common)
Relay resistance	2.6Ω(4 ohms Max.)
Output loss	360mW
Leakage current	1μA(Max.)
Response time (Max.)	1msec
I/O address	4 port occupation

Power consumption (Max.)	+5VDC 450mA
Bus/ Dimension (mm)	AT Bus /163.0(L)x122.0(H)
Connector	37-pin female D-type
Option	
Software	ACX-PAC(W32)BP, ACX-PAC(W32)AP, API-PAC(W32), SUPPORT-PAC(PC)601, DDE SERVER(W32)
Accessories	DTP-3(PC), DTP-4(PC), EPD-37*1
Cables/Connector	PCA37P, PCB37P, PCA37PS, PCB37PS

*1: Option cable of PCB37P or PCB37PS is required.

37-pin D-type connector board Accessories and Cable

Monitoring and dummy signal generator tool(32ch I/O signal)

CM-32(PC)E

The CM-32(PC)E is used to monitor the status of the signal line or to generate pseudo signals onto the signal line, making it easier to debug and check the behavior of programs.

- * It doesn't accept Bi-directional I/O type.
- * Cables is option

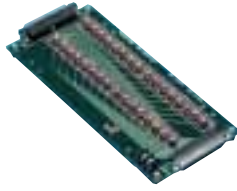

Terminal Unit (32ch I/O)

EPD-37

35mm DIN-Rail mountable
Compatible Boards : 32ch I/O Boards
Terminal pitch (10mm)



* Cables is option

DTP-3(PC)



* Cable (1m) attached

DTP-4(PC)



* Cable (1m) attached

Cables/Connector

37-pin D-type → 37-pin D-type Shield Cables

PCB37PS-0.5P	0.5m
PCB37PS-1.5P	1.5m
PCB37PS-3P	3.0m
PCB37PS-5P	5.0m



37-pin D-type → 37-pin D-type Flat Cables

PCB37P-1.5	1.5m
PCB37P-3	3.0m
PCB37P-5	5.0m

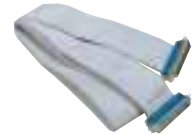

37-pin D-type → 37 wires (Pitch 1.27mm) Shield Cables

PCA37PS-0.5P	0.5m
PCA37PS-1.5P	1.5m
PCA37PS-3P	3.0m
PCA37PS-5P	5.0m



37-pin D-type → 37 wires (Pitch 1.27mm) Flat Cables

PCA37P-1.5	1.5m
PCA37P-3	3.0m
PCA37P-5	5.0m

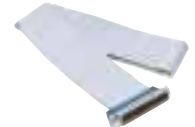

37-pin D-type (male) Connector 5pcs CN5-D37M

Easy soldering

CONFIGURATION GUIDE

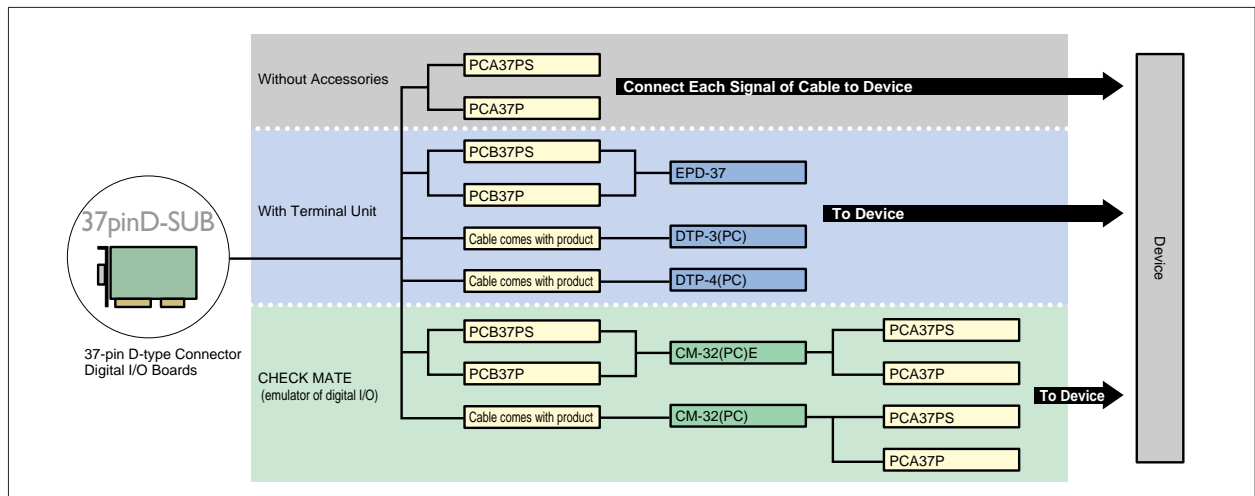

96-pin Half Pitch Connectors Board Accessories and cables

Monitoring and dummy signal generator tool(64ch I/O signal)

CM-64(PC)E

The CM-32(PC)E is used to monitor the status of the signal line or to generate pseudo signals onto the signal line, making it easier to debug and check the behavior of programs.

* Cables is option

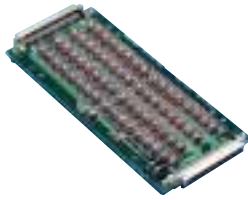

96-pin Half Pitch → 37-pin D-type (female) x 2 Connector Converter Board

CCB-96

The CCB-96 connector converter board converts 96-pin half pitch connectors to a pair of general-purpose, 37-pin female D-type connectors.

* Cables is option



Terminal Unit (64ch I/O)

EPD-96

35mm DIN-Rail mountable
Terminal pitch (8.5mm)

* Cables is option

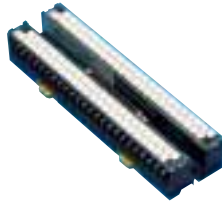

DTP-64(PC)

* Cables is option



Cables/Connector

96-pin Half Pitch → 96-pin Half Pitch Shield Cable

PCB96PS-1.5	1.5m
PCB96PS-3	3.0m
PCB96PS-5	5.0m



96-pin Half Pitch → 96-pin Half Pitch Flat Cable

PCB96P-1.5	1.5m
PCB96P-3	3.0m
PCB96P-5	5.0m

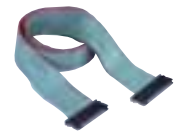

96-pin Half Pitch → 96 wires (Pitch 1.27mm) Shield Cables

PCA96PS-1.5	1.5m
PCA96PS-3	3.0m
PCA96PS-5	5.0m



96-pin Half Pitch → 96 wires (Pitch 1.27mm) Flat Cables

PCA96P-1.5	1.5m
PCA96P-3	3.0m
PCA96P-5	5.0m



96-pin Half Pitch → 37-pin D-type (male) x 2 Connector Converter Shield Cable

PCB96WS-1.5P	1.5m
PCB96WS-3P	3.0m
PCB96WS-5P	5.0m



96-pin Half Pitch → 37-pin D-type (male) x 2 Connector Converter Flat Cable

PCB96W-1.5	1.5m
PCB96W-3	3.0m
PCB96W-5	5.0m



96-pin Half Pitch (female) Connector 5pcs CN5-H96F

CONFIGURATION GUIDE

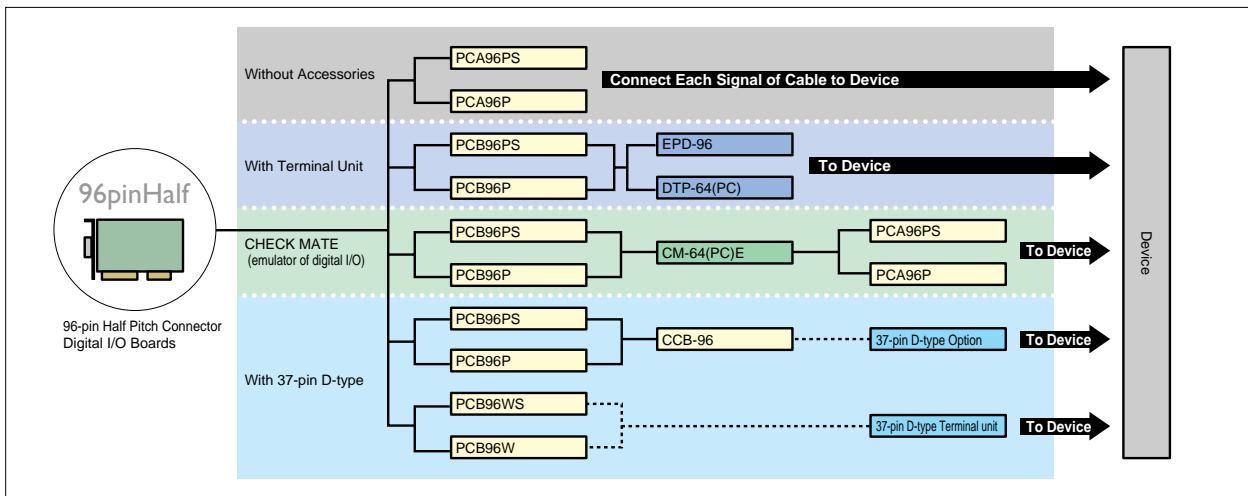

Digital I/O Board ACCESSORIES & CABLES

F-16

ISA BUS SERIES













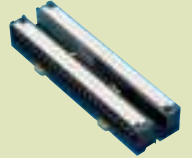

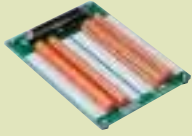

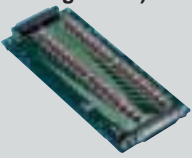
ISA BUS Series Selection Guide

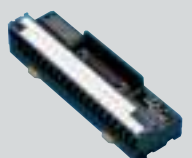
Digital I/O Boards

Analog I/O Boards

Communication Boards

Counter & Motor Controller

Connector of the Accessories side	Connector of the Board side		Model name of Digital I/O board					
	Accessories	Cables (both sides connector)	PI-64L(PC)	PI-64T(PC)	PO-64L(PC)	PO-64T(PC)	PIO-32/32L(PC)	
96-pin Half Pitch	CHECK MATE (emulator of digital I/O) CM-64(PC)E 230(W)x35(H)x105(D)mm 	Shield Cable PCB96PS-1.5 (1.5m) PCB96PS-3 (3m) PCB96PS-5 (5m) 	●	●	●	●	●	
		Flat Cable PCB96P-1.5 (1.5m) PCB96P-3 (3m) PCB96P-5 (5m) 	●	●	●	●	●	
	Terminal Unit EPD-96 219.5(W)x35.5(H)x64(D)mm 	Shield Cable PCB96PS-1.5 (1.5m) PCB96PS-3 (3m) PCB96PS-5 (5m) 	●	●	●	●	●	
		Flat Cable PCB96P-1.5 (1.5m) PCB96P-3 (3m) PCB96P-5 (5m) 	●	●	●	●	●	
	Screw-Type Terminal DTP-64(PC) 170(W)x122(H)mm 	Shield Cable PCB96PS-1.5 (1.5m) PCB96PS-3 (3m) PCB96PS-5 (5m) 	●	●	●	●	●	
		Flat Cable PCB96P-1.5 (1.5m) PCB96P-3 (3m) PCB96P-5 (5m) 	●	●	●	●	●	
	37-pin D-type	CHECK MATE (emulator of digital I/O) CM-32(PC)E 230(W)x35(H)x105(D)mm 	Shield Cable PCB37PS-0.5P (0.5m) PCB37PS-1.5P (1.5m) PCB37PS-3P (3m) PCB37PS-5P (5m) 					
			Flat Cable PCB37P-1.5 (1.5m) PCB37P-3 (3m) PCB37P-5 (5m) 					
		Terminal Unit EPD-37 226(W)x40.5(H)x64(D)mm 	Shield Cable PCB37PS-0.5P (0.5m) PCB37PS-1.5P (1.5m) PCB37PS-3P (3m) PCB37PS-5P (5m) 					
Flat Cable PCB37P-1.5 (1.5m) PCB37P-3 (3m) PCB37P-5 (5m) 								
Screw-Type Terminal DTP-3(PC) 190(W)x105(H)mm When board of a 96-pin type is used, two of them are required. 		Attached Cable for DTP-3(PC) (1m)						
		Shield Cable PCB96WS-1.5P (1.5m) PCB96WS-3P (3m) PCB96WS-5P (5m) 	●	●	●	●	●	
Screw-Type Terminal DTP-4 (PC) 160(W)x82(H)mm When board of a 96-pin type is used, two of them are required. 		Attached Cable for DTP-4(PC) (1m)						
		Shield Cable PCB96WS-1.5P(1.5m) PCB96WS-3P (3m) PCB96WS-5P (5m) 	●	●	●	●	●	
		Flat Cable PCB96W-1.5 (1.5m) PCB96W-3 (3m) PCB96W-5 (5m) 	●	●	●	●	●	

37-pin D-type

PIO-32/32RL(PC)	PIO-32/32T(PC)	PI-32L(PC)V	PI-32RL(PC)	PI-32B(PC)H	PI-32TB(PC)	PI-32T(PC)H	PO-32L(PC)V	PO-32RL(PC)	PO-32B(PC)H	PO-32TB(PC)	PO-32T(PC)H	PIO-16/16L(PC)V	PIO-16/16RL(PC)	PIO-16/16T(PC)H	PIO-16/16B(PC)H	PIO-16/16TB(PC)	IRT-16(PC)	RRY-32(PC)	PRY-32(PC)
•																			
•																			
•	•																		
•	•																		
•	•																		
•	•																		
			•	•	•	•	•	•	•	•	•	•	•	•	•	•	•	•	•
			•	•	•	•	•	•	•	•	•	•	•	•	•	•	•	•	•
			•	•	•	•	•	•	•	•	•	•	•	•	•	•	•	•	•
			•	•	•	•	•	•	•	•	•	•	•	•	•	•	•	•	•
•	•																		
•	•																		
•	•																		
•	•																		

DIN Rail Adapter

DIN-ADP1



DIN-rail adapter for termination panels

- For use with:
CM-64(PC)E,
CM-32(PC)E,
CCB-96

Digital I/O Board ACCESSORIES & CABLES

F-18

ISA BUS SERIES











ISA BUS Series Selection Guide

Digital I/O Boards

Analog I/O Boards

Communication Boards

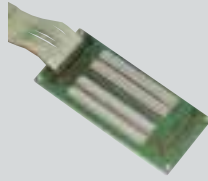
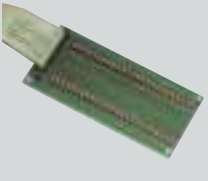
Counter & Motor Controller

Connector of the Accessories side	Connector of the Board side		Model name of Digital I/O board		37-pin D-type		
	Accessories	Cables (both sides connector)	PIO-24/24(PC)	PIO-48W(PC)			
37-pin D-type	Terminal Unit EPD-37 226(W)x40.5(H)x64(D)mm 	Shield Cable PCB37PS-0.5P (0.5m) PCB37PS-1.5P (1.5m) PCB37PS-3P (3m) PCB37PS-5P (5m) 	●※1	●※1			
		Flat Cable PCB37P-1.5 (1.5m) PCB37P-3 (3m) PCB37P-5 (5m) 	●※1	●※1			
	Screw-Type Terminal DTP-3(PC) 190(W)x105(H)mm 	Attached Cable for DTP-3(PC) (1m) 		●※1	●※1		
		Flat Cable DT/B2 30-pin Header to 37-pin D-type 	●※2	●※2			
	Screw-Type Terminal DTP-4(PC) 160(W)x82(H)mm 	Attached Cable for DTP-4(PC) (1m) 		●※1	●※1		
		Flat Cable DT/B2 30-pin Header to 37-pin D-type 	●※2	●※2			
50-pin Header	Screw-Type Terminal SCP-50H(98) 230(W)x105(H)mm 	SCP-50H(98)Cable comes with product					
	Screw-Type Terminal STP-50H(98) 230(W)x105(H)mm 	STP-50H(98)Cable comes with product					
	Terminal Unit PSD-50(98)J 283(W)x60(H)mm 	PSD-50(98)JCable comes with product					

*1:24 signal is assigned to D-type 37-pin connector(CN1). Rest of signals is assigned to pin-header connector(CN2) on board.

*2:DT/B2 is necessary when all signals of PIO-48W(PC) or PIO-24/24(PC) are used.

*3:Four DT/B2 are necessary when all signals of PIO-96W(PC) are used.

Also, 4 pcs are necessary when accessory is used.

*4:In order to use the number of all points of I/O board, accessories are required for the number of pin connectors.

PIO-48D(PC)x2, PIO-120D(PC)x5, PIO-144W(PC)x6

	30-pin Header Connector		50-pin Header Connector	
	PIO-96W(PC)	PIO-48D(PC)	PIO-120D(PC)	PIO-144W(PC)
	●※3			
	●※3			
		●※4	●※4	●※4
		●※4	●※4	●※4
		●※4	●※4	●※4

Digital I/O Board ACCESSORIES & CABLES

F-20

ISA BUS SERIES

ISA BUS Series Selection Guide

Digital I/O Boards

Analog I/O Boards

Communication Boards

Counter & Motor Controller

▶ Connector of the Board side		96-pin Half Pitch							37-pin D-type						
▶ Connector of the Accessories side	Model name of Digital I/O board	PI-64L(PC)	PI-64T(PC)	PO-64L(PC)	PO-64T(PC)	PIO-32/32L(PC)	PIO-32/32RL(PC)	PI-32L(PC)V	PI-32RL(PC)	PI-32B(PC)H	PI-32T(PC)	PO-32L(PC)V			
	Cables (One side connector)														
96-pin Half Pitch	Shield Cable PCA96PS-1.5 (1.5m) PCA96PS-3 (3m) PCA96PS-5 (5m)		•	•	•	•	•	•							
	Flat Cable PCA96P-1.5 (1.5m) PCA96P-3 (3m) PCA96P-5 (5m)		•	•	•	•	•	•							
37-pin D-type	Flat Cable PCA37P-1.5 (1.5m) PCA37P-3 (3m) PCA37P-5 (5m)								•	•	•	•	•	•	
	Flat Cable DT/B2 30-pin Header to 37-pin D-type								•	•	•	•	•	•	
	Shield Cable PCA37PS-0.5P (0.5m) PCA37PS-1.5P (1.5m) PCA37PS-3P (3m) PCA37PS-5P (5m)														
	Flat Cable DT/B2 30-pin Header to 37-pin D-type														
50-pin Header	Flat Cable PCA50J-1.5 (1.5m) PCA50J-3 (3m) PCA50J-5 (5m)														

*1:24 signal is assigned to D-type 37-pin connector(CN1). Rest of signals is assigned to pin-header connector(CN2) on board.
 *2:DT/B2 is necessary when all signals of PIO-48W(PC) or PIO-24/24(PC) are used.
 *3:Four DT/B2 are necessary when all signals of PIO-96W(PC) are used.
 Also, 4 pcs are necessary when accessory is used.
 *4:In order to use the number of all points of I/O board, accessories are required for the number of pin connectors.
 PIO-48D(PC)x2, PIO-120D(PC)x5, PIO-144W(PC)x6

														30-pin Header Connector			50-pin Header	
PO-32RL(PC)	PO-32B(PC)H	PO-32TB(PC)	PO-32T(PC)H	PIO-16/16L(PC)V	PIO-16/16RL(PC)	PIO-16/16B(PC)H	PIO-16/16TB(PC)	IRT-16(PC)	PRY-32(PC)	RRY-32(PC)	PIO-24/24(PC)	PIO-48W(PC)	PIO-96W(PC)	PIO-48D(PC)	PIO-120D(PC)	PIO-144W(PC)		
	●	●	●	●	●	●	●	●	●	●	●※1	●※1						
	●	●	●	●	●	●	●	●	●	●	●※2	●※2	●※3					
											●※1	●※1						
											●※2	●※2	●※3					
																●※4 ●※4 ●※4		

Analog I/O Boards

F-22

ISA BUS SERIES

Multi-Function A/D Board AD12-16(PC)EH



■ SPECIFICATIONS

Inputs channels	16 single-ended or 8 differential inputs
Outputs channels	1ch
Resolution	12bit
Input specification	
Input Range	±10V, 0 - 10V
Input gain	x1, x2, x4, x8(specifiable by software for each channel)
Conversion Speed	10 μ sec/ch(Max.)
Non-linearity error *1	±2LSB(x1, x2) ±4LSB(x4, x8)
Input Impedance	1M Ω or more
Output specification	
Output Range	±5V, ±10V, 0-10V
Output rating	Maximum drive current ±5mA(Max.)
Conversion Speed	6 μ sec/ch
Non-linearity error *1	±1/2LSB
Output impedance	1 Ω or less
Trigger	Start Trigger: 3 Mode Stop Trigger: 4 Mode
Isolation	-
Timer	2 - 7x10 ¹³ μ sec
Digital I/O	
	General Digital I/O: Input 4, Output 4(TTL-level)
	Sampling Control DIO: Input 3, Output 1(TTL-level)

ISA BUS Series
Selection
GuideDigital I/O
BoardsAnalog I/O
BoardsCommunication
BoardsCounter &
Motor
Controller

High Speed Multi-Function A/D Board AD12-16U(PC)EH



■ SPECIFICATIONS

Inputs channels	16 single-ended or 8 differential inputs
Outputs channels	1ch
Resolution	12bit
Input specification	
Input Range	±2.5V, ±5V, 0-5V, 0-10V
Input gain	-
Conversion Speed	1 μ sec/ch(Max.)
Non-linearity error *1	±3LSB
Input Impedance	1M Ω or more
Output specification	
Output Range	±5V, ±10V, 0-10V
Output rating	Maximum drive current ±5mA(Max.)
Conversion Speed	6 μ sec/ch
Non-linearity error *1	±1/2LSB
Output impedance	1 Ω or less
Trigger	Start Trigger: 3 Mode Stop Trigger: 4 Mode
Isolation	-
Timer	2 - 7x10 ¹³ μ sec
Digital I/O	
	General Digital I/O: Input 4, Output 4(TTL-level)
	Sampling Control DIO: Input 3, Output 1(TTL-level)



FEATURES

- 256K-word on board memory to maximize A/D sampling speeds and enable background processing
- Various A/D sampling control functions
- Four TTL level digital input and four TTL level digital output channels, One i8254 compatible counter

Interrupt	
Interrupt Request Causes	Up to 16 causes
Interrupt Request Level	One of IRQ 5, 7, 9, 10, 11, 12 or 15
I/O address	Any 16-byte boundary
Power consumption (Max.)	+5VDC 800mA
Bus/Dimension (mm)	AT Bus /163.0(L)x122.0(H)
Connector	
	CN1(AIO): 37-pin female D-type CN2(DIO): 16-pin header
Option	
Software	ACX-PAC(W32)BP, ACX-PAC(W32)AP, API-PAC(W32), SUPPORT-PAC(PC)306, DDE SERVER(W32)
Accessories	DTP-3(PC), DTP-4(PC), ATCH-16(PC), ATP-16 ^{*2} , FTP-15 ^{*3} , EPD-37 ^{*2} , ATSS-16 ^{*2} , ATII-8A ^{*2} , ATLF-8 ^{*2}
Cables/Connector	PCA37P, PCB37P, PCA37PS, PCB37PS, PCA15P ^{*4} , PCB15P ^{*4} , PCC16PS, PCD8PS, DT/E1, DT/E2

*1:Conversion Accuracy:A value in the table is linearity error at 25 degree.
*2:Option cable of PCB37P or PCB37PS is required.
*3:Option cableDT/E2 and PCB15P is required.
*4:PCB15P is a cable for FTP-15 terminal panel.

FEATURES

- 1 μ sec(1MHz) A/D conversion speed
- 256K-word on board memory to maximize A/D sampling speeds and enable background processing
- Various A/D sampling control functions
- Four TTL level digital input and four TTL level digital output channels, One i8254 compatible counter

Interrupt	
Interrupt Request Causes	Up to 16 causes
Interrupt Request Level	One of IRQ 5, 7, 9, 10, 11, 12 or 15
I/O address	Any 16-byte boundary
Power consumption (Max.)	+5VDC 1700mA
Bus/Dimension (mm)	AT Bus /174.0(L)x122.0(H)
Connector	
	CN1(AIO): 37-pin female D-type CN2(DIO): 16-pin header
Option	
Software	ACX-PAC(W32)BP, ACX-PAC(W32)AP, API-PAC(W32), SUPPORT-PAC(PC)306, DDE SERVER(W32)
Accessories	DTP-3(PC), DTP-4(PC), ATUH-16(PC), ATP-16 ^{*2} , FTP-15 ^{*3} , EPD-37 ^{*2} , ATSS-16 ^{*2} , ATII-8A ^{*2} , ATLF-8 ^{*2}
Cables/Connector	PCA37P, PCB37P, PCA37PS, PCB37PS, PCA15P ^{*4} , PCB15P ^{*4} , PCC16PS, PCD8PS, DT/E1, DT/E2

*1:Conversion Accuracy:A value in the table is linearity error at 25 degree.
*2:Option cable of PCB37P or PCB37PS is required.
*3:Option cableDT/E2 and PCB15P is required.
*4:PCB15P is a cable for FTP-15 terminal panel.

16-Bit Multi-Function A/D Board AD16-16(PC)EH



Non Isolated Memory on board Hi Precision

FEATURES

- 256K-word on board memory to maximize A/D sampling speeds and enable background processing
- Various A/D sampling control functions
- Four TTL level digital input and four TTL level digital output channels, One i8254 compatible counter

SPECIFICATIONS

Inputs channels	16 single-ended or 8 differential inputs
Outputs channels	1ch
Resolution	16bit
Input specification	
Input Range	±5V, ±10V, 0-5V, 0-10V
Input gain	-
Conversion Speed	10 μsec/ch(Max.)
Non-linearity error *1	±5LSB
Input Impedance	1MΩ or more
Output specification	
Output Range	±10V, 0-10V
Output rating	Maximum drive current ±5mA(Max.)
Conversion Speed	13 μsec/ch
Non-linearity error *1	±2LSB
Output impedance	1Ω or less
Trigger	Start Trigger: 3 Mode Stop Trigger: 4 Mode
Isolation	-
Timer	2 - 7x10 ¹³ μ sec
Digital I/O	
	General Digital I/O: Input 4, Output 4(TTL-level)
	Sampling Control DIO: Input 3, Output 1(TTL-level)

Interrupt	
Interrupt Request Causes	Up to 16 causes
Interrupt Request Level	One of IRQ 5, 7, 9, 10, 11, 12 or 15
I/O address	Any 16-byte boundary
Power consumption (Max.)	+5VDC 1000mA
Bus/Dimension (mm)	AT Bus /163.0(L)x122.0(H)
Connector	CN1(AIO): 37-pin female D-type CN2(DIO): 16-pin header
Option	
Software	ACX-PAC(W32)BP, ACX-PAC(W32)AP, API-PAC(W32), SUPPORT-PAC(PC)306, DDE SERVER(W32)
Accessories	DTP-3(PC), DTP-4(PC), ATCH-16(PC), ATP-16*, FTP-15*, EPD-37*, ATSS-16*, ATII-8A*, ATLF-8*
Cables/Connector	PCA37P, PCB37P, PCA37PS, PCB37PS, PCA15P*, PCB15P*, PCC16PS, PCD8PS, DT/E1, DT/E2

*1:Conversion Accuracy:A value in the table is linearity error at 25 degree.
*2:Option cable of PCB37P or PCB37PS is required.
*3:Option cableDT/E2 and PCB15P is required.
*4:PCB15P is a cable for FTP-15 terminal panel.

16-Bit High Speed Multi-Function A/D Board AD16-16U(PC)EH



Non Isolated Memory on board Hi Speed Hi Precision

FEATURES

- 1 μ sec(1MHz) A/D conversion speed
- 256K-word on board memory to maximize A/D sampling speeds and enable background processing
- Various A/D sampling control functions
- Four TTL level digital input and four TTL level digital output channels, One i8254 compatible counter

SPECIFICATIONS

Inputs channels	16 single-ended or 8 differential inputs
Outputs channels	1ch
Resolution	16bit
Input specification	
Input Range	±2.5V, ±5V, ±10V, 0-5V, 0-10V
Input gain	-
Conversion Speed	1 μsec/ch(Max.)
Non-linearity error *1	±5LSB
Input Impedance	1MΩ or more
Output specification	
Output Range	±10V, 0-10V
Output rating	Maximum drive current ±5mA(Max.)
Conversion Speed	13 μsec/ch
Non-linearity error *1	±2LSB
Output impedance	1Ω or less
Trigger	Start Trigger: 3 Mode Stop Trigger: 4 Mode
Isolation	-
Timer	2 - 7x10 ¹³ μ sec
Digital I/O	
	General Digital I/O: Input 4, Output 4(TTL-level)
	Sampling Control DIO: Input 3, Output 1(TTL-level)

Interrupt	
Interrupt Request Causes	Up to 16 causes
Interrupt Request Level	One of IRQ 5, 7, 9, 10, 11, 12 or 15
I/O address	Any 16-byte boundary
Power consumption (Max.)	+5VDC 2000mA
Bus/Dimension (mm)	AT Bus /340.5(L)x122.0(H)
Connector	CN1(AIO): 37-pin female D-type CN2(DIO): 16-pin header
Option	
Software	ACX-PAC(W32)BP, ACX-PAC(W32)AP, API-PAC(W32), SUPPORT-PAC(PC)306, DDE SERVER(W32)
Accessories	DTP-3(PC), DTP-4(PC), ATUH-16(PC), ATP-16*, FTP-15*, EPD-37*, ATSS-16*, ATII-8A*, ATLF-8*
Cables/Connector	PCA37P, PCB37P, PCA37PS, PCB37PS, PCA15P*, PCB15P*, PCC16PS, PCD8PS, DT/E1, DT/E2

*1:Conversion Accuracy:A value in the table is linearity error at 25 degree.
*2:Option cable of PCB37P or PCB37PS is required.
*3:Option cableDT/E2 and PCB15P is required.
*4:PCB15P is a cable for FTP-15 terminal panel.

Multi-Function A/D Board Accessories & Cables for E series

Industrial Automation Products

F-24

ISA BUS SERIES

ISA BUS Series Selection Guide

Digital I/O Boards

Analog I/O Boards

Communication Boards

Counter & Motor Controller

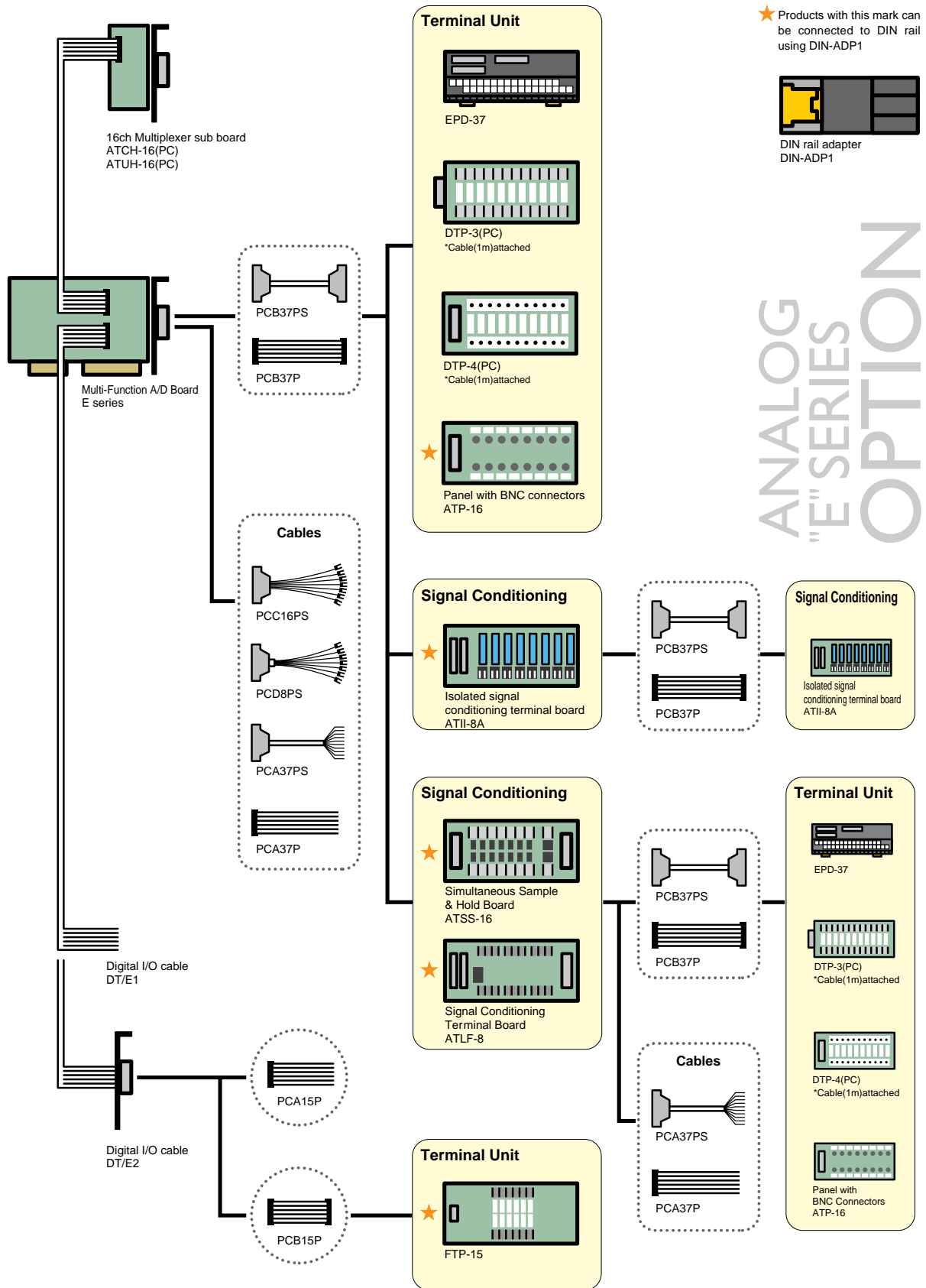

Multi-Function A/D Board Accessories & Cables

16ch Multiplexer Sub-Board

16 single-ended or 8 differential input

* ATCH-16(PCI) or ATUH-16(PCI) occupies one slot.

ATCH-16(PC)

For use with:
AD12-16(PC)EH
AD16-16(PC)EH

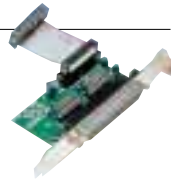

ATUH-16(PC)

For use with:
AD12-16U(PC)EH
AD16-16U(PC)EH

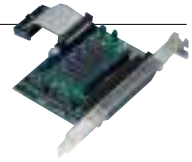

16 Channel Simultaneous Sample & Hold Board

ATSS-16

ATSS-16 is a accessory board that provides simultaneous sampling function for the Analog E series boards.

* ATSS-16 is available at single ended input mode.



For use with: * Cables is option
AD12-16(PC)EH
AD16-16(PC)EH
AD12-16U(PC)EH
AD16-16U(PC)EH

8 Channel Isolated Signal Conditioning Terminal Board

ATII-8A

ATII-8A contains 8 isolation amplifier channels. The board provides isolation between the input and output signals and also between channels. The input gain can be set independently for each channel to either 1 or 200. ATII-8A has a cold junction compensation (CJC) circuit used for all eight channels.

* ATII-8A is available at single ended input mode. When using 16 channels, two pieces of ATII-8A is required.



For use with: * Cables is option
AD12-16(PC)EH
AD16-16(PC)EH
AD12-16U(PC)EH
AD16-16U(PC)EH

8 Channel Signal Conditioning Terminal Board

ATLF-8

8 differential gain amplifiers with bandwidth of 0-100KHz, with up to 500 times signal gain. Each input channel has an on-board 4th order lowpass Butterworth filter (values jumper selectable). A semiconductor temperature sensor is used to compensate for thermocouple signal deviations.

*ATLF-8 is available at single ended input mode. When using 16 channels, two pieces of ATLF-8 is required.



For use with: * Cables is option
AD12-16(PC)EH
AD16-16(PC)EH
AD12-16U(PC)EH
AD16-16U(PC)EH

DIN Rail Adapter

DIN-ADP1

DIN-rail adapter for termination panels



Accessory:
ATSS-16 ATP-16
ATII-8A FTP-15
ATLF-8

Accessories for AIO

■ Panel With BNC Connectors *Cables is option
ATP-16

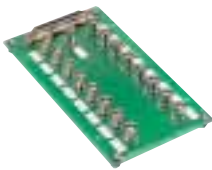

■ Shield Cable for Differential Inputs
PCD8PS-1.5 1.5m

PCD8PS-3 3.0m



■ Coaxial Cable for Single-Ended inputs
PCC16PS-1.5 1.5m

PCC16PS-3 3.0m



Digital I/O Accessories

■ Termination Panel
FTP-15

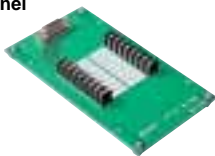

■ 16-pin Header → 15-pin D-type Connector Cable
DT/E2

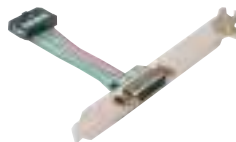

■ 16-pin D-type → 16(End Open) Flat Cable (1.5m)
DT/E1



■ 15-pin D-type → 15-pin
D-type Flat Cable

PCB15P-1.5 1.5m
PCB15P-3 3.0m
PCB15P-5 5.0m



■ 15-pin D-type → 15
(End Open) Flat Cable

PCA15P-1.5 1.5m
PCA15P-3 3.0m
PCA15P-5 5.0m



8 Single-Ended Analog to Digital Inputs Board AD12-8LT(PC)

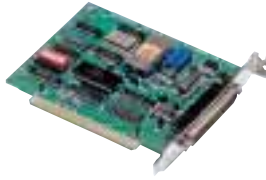

Non Isolated

SPECIFICATIONS

Inputs channels	8 single-ended inputs
Resolution	12bit
Input specification	
Input Range	±5V
Input gain	-
Conversion Speed	25 μsec/ch
Non-linearity error *1	±3LSB
Input Impedance	100MΩ or more
Output specification	
Output Range	-
Output rating	-
Conversion Speed	-
Non-linearity error *1	-
Output impedance	-
Trigger	1 TTL input
Isolation	-
Timer	16 bits down counter x 3 (82C54 or equivalent)
Digital I/O	3-TTL level input, 4-CMOS level output (Negative logic)

FEATURES

- Low power (+5VDC and +12VDC) consumption
- On-board clock of the timer is 1MHz
- 3 TTL level digital input and 4 TTL level digital output channels

Interrupt	
Interrupt Request Causes	External trigger
Interrupt Request Level	One of IRQ 3-7, 9
I/O address	Any 8-byte boundary
Power consumption (Max.)	+5VDC 40mA DC12V 15mA
Bus/Dimension (mm)	XT Bus /130.0(L)x107.0(H)
Connector	37-pin male D-type
Option	
Software	ACX-PAC(W32)BP, ACX-PAC(W32)AP, API-PAC(W32), SUPPORT-PAC(PC)305, DDE SERVER(W32)
Accessories	DTP-3(PC)*2, DTP-4(PC)*2, EPD-37*2, ATP-M3*3
Cables/Connector	DT-6, DT-11

*1:Conversion Accuracy:A value in the table is linearity error at 25 degree.
*2:Option cable of DT-6 is required.
*3:Option cable of DT-11 is required.

16 Channel Input Multiplexer With Selectable Gain ATP-M3



SPECIFICATIONS

Inputs channels	16 differential input
accuracy	0.01%
Input Range	-10V~+10V
Input gain	x1, x10, x100, x200, x500
Offset	±15 μA/°C

FEATURES

- 16CH Expansion board for AD12-8LT(PC)
- Gain range of 1 to 500 (jumper selectable)
- Up to 128 channels using 8 ATP-M3s

Output voltage of cold junction compensation	24mV/°C:(Zero crossing: 0.0 V at 0.0 deg.)
Power consumption (Max.)	+5VDC 22mA:26mA, +12VDC 17mA:20mA, -12VDC 14mA:16mA
Outside Dimensions (mm)	247.0x101.0x19.0

Analog to Digital Input Board AD12-16(PC)

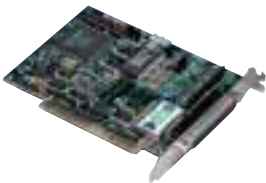

Non Isolated



SPECIFICATIONS

Inputs channels	16 single-ended or 8 differential inputs
Resolution	12bit
Input specification	
Input Range	±5V, ±10V, 0-10V
Input gain	-
Conversion Speed	20 μsec/ch
Non-linearity error *1	±2LSB
Input Impedance	1MΩ or more
Output specification	
Output Range	-
Output rating	-
Conversion Speed	-
Non-linearity error *1	-
Output impedance	-
Trigger	1 TTL input
Isolation	-

FEATURES

- 16 single-ended analog inputs or 8 differential analog inputs
- 1 TTL-level digital inputs and 1 TTL-level digital outputs
- External trigger input capability

Timer	2 - 7x10 ⁻⁹ μ sec
Digital I/O	TTL Level input one interrupt request signal as INTA, Output one interrupt request signal as INTA(Negative logic)
Interrupt	
Interrupt Request Causes	External trigger/Timer/Transformation end
Interrupt Request Level	One of IRQ 3-7, 9
I/O address	Any 16-byte boundary
Power consumption (Max.)	+5VDC 700mA
Bus/Dimension (mm)	XT Bus /143.0(L)x107.0(H)
Connector	37-pin female D-type
Option	
Software	ACX-PAC(W32)BP, ACX-PAC(W32)AP, API-PAC(W32), DDE SERVER(W32), SUPPORT-PAC(PC)301
Accessories	DTP-3(PC), DTP-4(PC), EPD-37*2
Cables/Connector	PCA37P, PCB37P, PCA37PS, PCB37PS

*1:Conversion Accuracy:A value in the table is linearity error at 25 degree.
*2:Option cable of PCB37P or PCB37PS is required.

Isolated Analog to Digital Input Board

ADI12-8CL(PC)H



Isolated

SPECIFICATIONS

Inputs channels	8ch
Outputs channels	-
Resolution	12bit
Input specification	
Input Range	0-5V, 1-5V, 0-20mA, 4-20mA
Input gain	-
Conversion Speed	1200 μsec/ch
Non-linearity error *1	±3LSB
Input Impedance	1MΩ min. (250Ω for current input)
Output specification	
Output Range	-
Output rating	-
Conversion Speed	-
Non-linearity error *1	-
Output impedance	-
Trigger	1 opto-isolated input (shares one of Digital input)
Isolation	Individual Isolation

FEATURES

- 8 isolated differential input channels
- 4 opto-isolated digital output and 2 opto-isolated digital input channels
- Channel to channel, input to output analog isolation

Timer	-
Digital I/O	Opto-Isolated Input 2 channels(Negative logic) 4 channels(Negative logic)
Interrupt	
Interrupt Request Causes	External trigger/Transformation end
Interrupt Request Level	One of IRQ 3-7, 9-12, 14 or 15
I/O address	4 port occupation
Power consumption (Max.)	+5VDC 500mA
Bus/Dimension (mm)	AT Bus /163.0(L)x122.0(H)
Connector	37-pin female D-type
Option	
Software	ACX-PAC(W32)BP, ACX-PAC(W32)AP, API-PAC(W32), SUPPORT-PAC(PC)302, DDE SERVER(W32)
Accessories	DTP-3(PC), DTP-4(PC), EPD-37*2
Cables/Connector	PCA37P, PCB37P, PCA37PS, PCB37PS

*1:Conversion Accuracy:A value in the table is linearity error at 25 degree.
*2:Option cable of PCB 37P or PCB 37PS is required

Low Cost 16ch single-Ended Input Analog to Digital Board

AD12-16LG(PC)



Non Isolated Gain Amp. CE

SPECIFICATIONS

Inputs channels	16 single-ended inputs
Outputs channels	-
Resolution	12bit
Input specification	
Input Range	±5V
Input gain	x1, x2, x4, x8, x16(specifiable by software for each channel)
Conversion Speed	15 μsec/ch
Non-linearity error *1	±3LSB
Input Impedance	100MΩ or more
Output specification	
Output Range	-
Output rating	-
Conversion Speed	-
Non-linearity error *1	-
Output impedance	-
Trigger	1 TTL input
Isolation	-

FEATURES

- Programmable gains of 1, 2, 4, 8 and 16
- One programmable timer for periodic sampling
- 8 TTL level digital input channels and 8 TTL level digital output channels

Timer	2 - 7x10 ¹³ μ sec
Digital I/O	TTLLevelInput8 channels, Output8 channels(positive logic)
Interrupt	
Interrupt Request Causes	end of conversion
Interrupt Request Level	One of IRQ 3-7, 9
I/O address	Any 8-byte boundary
Power consumption (Max.)	+5VDC 400mA DC ±12V 25mA
Bus/Dimension (mm)	XT Bus /143.0(L)x107.0(H)
Connector	37-pin male D-type
Option	
Software	ACX-PAC(W32)BP, ACX-PAC(W32)AP, API-PAC(W32), SUPPORT-PAC(PC)304, DDE SERVER(W32)
Accessories	DTP-3(PC)*2, DTP-4(PC)*2, EPD-37*2
Cables/Connector	DT-6, DT-11

*1:Conversion Accuracy:A value in the table is linearity error at 25 degree.
*2:Option cable of DT-6 is required.

Opto-Isolated Analog to Digital Board

ADI12-16(PC)



Isolated CE

SPECIFICATIONS

Inputs channels	16 single-ended or 8 differential inputs
Outputs channels	-
Resolution	12bit
Input specification	
Input Range	±10V, ±5V, 0-10V, 4-20mA
Input gain	-
Conversion Speed	25 μsec/ch
Non-linearity error *1	±3LSB
Input Impedance	1M Ohms min. (250 Ohms for current input)
Output specification	
Output Range	-
Output rating	-
Conversion Speed	-
Non-linearity error *1	-
Output impedance	-
Trigger	1 opto-isolated input(shared signal of Rising-Edge or digital input)

FEATURES

- 16 single-ended or 8 differential analog input channels
- 4 digital output and 2 digital input channels
- PC bus signals isolated from external analog signals

Isolation	PCI bus signal isolated from external analog and digital signals
Timer	-
Digital I/O	2 opto-isolated inputs, 4 opto-isolated outputs
Interrupt	
Interrupt Request Causes	External trigger/Transformation end
Interrupt Request Level	One of IRQ 3-7, 9-12, 14 or 15
I/O address	4 port occupation
Power consumption (Max.)	+5VDC 850mA
Bus/Dimension (mm)	AT Bus /163.0(L)x122.0(H)
Connector	37-pin female D-type
Option	
Software	ACX-PAC(W32)BP, ACX-PAC(W32)AP, API-PAC(W32), SUPPORT-PAC(PC)303, DDE SERVER(W32)
Accessories	DTP-3(PC), DTP-4(PC), EPD-37*2
Cables/Connector	PCA37P, PCB37P, PCA37PS, PCB37PS

*1:Conversion Accuracy:A value in the table is linearity error at 25 degree.
*2:Option cable of PCB37P or PCB37PS is required.

Digital to Analog Output Board

DA12-4(PC)



SPECIFICATIONS

Inputs channels	-
Outputs channels	4ch
Resolution	12bit
Input specification	
Input Range	-
Input gain	-
Conversion Speed	-
Non-linearity error *1	-
Input Impedance	-
Output specification	
Output Range	±5V, ±10V, 0-10V
Output rating	±5mA
Conversion Speed	5 μsec/ch
Non-linearity error *1	±1LSB
Output impedance	1Ω or less
Trigger	1 TTL input
Isolation	-

FEATURES

- 4 channels for the analog output function for converting 12bit digital signals to analog voltages
- Independent, TTL-level external trigger input function

Timer	2 - 7x10 ¹⁹ Ω sec
Digital I/O	
TTL Level input one interrupt request signal as INTA, Output one interrupt request signal as INTA(Negative logic)	
Interrupt	
Interrupt Request Causes	External trigger/Timer
Interrupt Request Level	One of IRQ 3-7, 9
I/O address	Any 16-byte boundary
Power consumption (Max.)	+5VDC 1200mA
Bus/Dimension (mm)	XT Bus /143.0(L)x107.0(H)
Connector	37-pin female D-type
Option	
Software	ACX-PAC(W32)BP, ACX-PAC(W32)AP, API-PAC(W32), SUPPORT-PAC(PC)351, DDE SERVER(W32)
Accessories	DTP-3(PC), DTP-4(PC), EPD-37*2
Cables/Connector	PCA37P, PCB37P, PCA37PS, PCB37PS

*1:Conversion Accuracy:A value in the table is linearity error at 25 degree.
*2:Option cable of PCB37P or PCB37PS is required.

Low Cost 6 Channel Digital to Analog Board

DA12-6LC(PC)

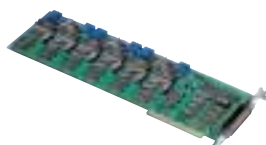

SPECIFICATIONS

Inputs channels	-
Outputs channels	6ch
Resolution	12bit
Input specification	
Input Range	-
Input gain	-
Conversion Speed	-
Non-linearity error *1	-
Input Impedance	-
Output specification	
Output Range	±2.5V, ±5V, ±10V, 0-5V, 0-10V, 4-20mA
Output rating	±5mA(voltage output)
Conversion Speed	4 μsec/ch
Non-linearity error *1	±3LSB
Output impedance	0.1Ω or less(voltage output)
Trigger	-
Isolation	-

FEATURES

- 6 independent D/A outputs
- 24 programmable digital I/Os
- High speed D/A conversion - 4 μ sec

Isolation	-
Timer	-
Digital I/O	24 channels TTL-level(i8255 or equivalent)
Interrupt	
Interrupt Request Causes	-
Interrupt Request Level	-
I/O address	Any 16-byte boundary
Power consumption (Max.)	+5VDC 700mA DC ±12V 120mA
Bus/Dimension (mm)	XT Bus /340.5(L)x107.0(H)
Connector	37-pin male D-type
Option	
Software	ACX-PAC(W32)BP, ACX-PAC(W32)AP, API-PAC(W32), SUPPORT-PAC(PC)353, DDE SERVER(W32)
Accessories	DTP-3(PC)*2, DTP-4(PC)*2, EPD-37*2
Cables/Connector	DT-6, DT-11

*1:Conversion Accuracy:A value in the table is linearity error at 25 degree.
*2:Option cable of DT-6 is required.

Digital to Analog Output Board

DA12-8L(PC)



SPECIFICATIONS

Inputs channels	-
Outputs channels	8ch
Resolution	12bit
Input specification	
Input Range	-
Input gain	-
Conversion Speed	-
Non-linearity error *1	-
Input Impedance	-
Output specification	
Output Range	±5V, ±10V, 0-10V, 4-20mA(1ch)
Output rating	±5mA(voltage output)
Conversion Speed	10 μsec/ch
Non-linearity error *1	±3LSB
Output impedance	1Ω or less(voltage output)
Trigger	-
Isolation	-

FEATURES

- D/A conversion time 10 μ sec /channel
- One channel can output 4 to 20mA
- Four TTL digital inputs and four TTL digital outputs

Isolation	-
Timer	-
Digital I/O	Input 4, Output 4(TTL-level positive logic)
Interrupt	
Interrupt Request Causes	-
Interrupt Request Level	-
I/O address	4 port occupation
Power consumption (Max.)	+5VDC 830mA
Bus/Dimension (mm)	AT Bus / 163.0(L)x122.0(H)
Connector	37-pin female D-type
Option	
Software	ACX-PAC(W32)BP, ACX-PAC(W32)AP, API-PAC(W32), DDE SERVER(W32)
Accessories	DTP-3(PC), DTP-4(PC), EPD-37*2
Cables/Connector	PCA37P, PCB37P, PCA37PS, PCB37PS

*1:Conversion Accuracy:A value in the table is linearity error at 25 degree.
*2:Option cable of PCB37P or PCB37PS is required.

16-Bit Digital to Analog Output Board DA16-4D(PC)



FEATURES

- Simultaneous D/A conversion for all outputs
- On board timer for precise timing outputs
- DMA function

SPECIFICATIONS

Inputs channels	-
Outputs channels	4ch
Resolution	16bit
Input specification	
Input Range	-
Input gain	-
Conversion Speed	-
Non-linearity error *1	-
Input Impedance	-
Output specification	
Output Range	±10V, 0-10V
Output rating	±5mA
Conversion Speed	13 μsec/ch
Non-linearity error *1	±3LSB
Output impedance	1Ω or less
Trigger	-

Isolation	-
Timer	-
Digital I/O	-
Interrupt	
Interrupt Request Causes	End of DMA transfer
Interrupt Request Level	One of IRQ 3-7,9-12,14 or 15
I/O address	Any 8-byte boundary
Power consumption (Max.)	+5VDC 980mA
Bus/ Dimension (mm)	AT Bus / 163.0(L)x122.0(H)
Connector	37-pin female D-type
Option	
Software	-
Accessories	DTP-3(PC), DTP-4(PC), EPD-37*2
Cables/Connector	PCA37P, PCB37P, PCA37PS, PCB37PS

*1:Conversion Accuracy:A value in the table is linearity error at 25 degree.
*2:Option cable of PCB37P or PCB37PS is required.

Opto-Isolated Digital to Analog Board DAI12-4C(PC)

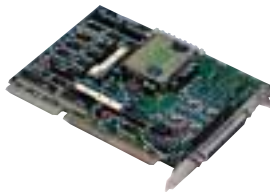

FEATURES

- 4 analog outputs - 0-5V and 4-20mA
- 4 digital output and 2 input channels
- PC bus isolated from external signals

SPECIFICATIONS

Inputs channels	-
Outputs channels	4ch
Resolution	12bit
Input specification	
Input Range	-
Input gain	-
Conversion Speed	-
Non-linearity error *1	-
Input Impedance	-
Output specification	
Output Range	0 - 5V, 4-20mA
Output rating	±5mA(voltage output)
Conversion Speed	24 μsec/ch
Non-linearity error *1	±2LSB
Output impedance	1Ω or less(voltage output)
Trigger	-

Isolation	ISA bus signal isolated from external analog and digital signals
Timer	-
Digital I/O	2 opto-isolated inputs, 4 opto-isolated outputs
Interrupt	
Interrupt Request Causes	-
Interrupt Request Level	-
I/O address	4 port occupation
Power consumption (Max.)	+5VDC 1200mA
Bus/ Dimension (mm)	AT Bus /163.0(L)x122.0(H)
Connector	37-pin female D-type
Option	
Software	ACX-PAC(W32)BP, ACX-PAC(W32)AP, API-PAC(W32), DDE SERVER(W32)
Accessories	DTP-3(PC), DTP-4(PC), EPD-37*2
Cables/Connector	PCA37P, PCB37P, PCA37PS, PCB37PS

*1:Conversion Accuracy:A value in the table is linearity error at 25 degree.
*2:Option cable of PCB37P or PCB37PS is required.

Opto-Isolated Digital to Analog Board DAI12-8C(PC)

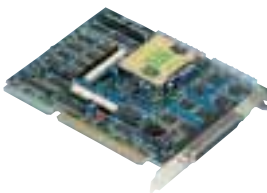

FEATURES

- 8 analog outputs - 0-5V and 4-20mA
- 4 digital output and 2 input channels
- PC bus isolated from external signals

SPECIFICATIONS

Inputs channels	-
Outputs channels	8ch
Resolution	12bit
Input specification	
Input Range	-
Input gain	-
Conversion Speed	-
Non-linearity error *1	-
Input Impedance	-
Output specification	
Output Range	0 - 5V, 4-20mA
Output rating	±5mA(voltage output)
Conversion Speed	24 μsec/ch
Non-linearity error *1	±2LSB
Output impedance	1Ω or less(voltage output)
Trigger	-

Isolation	ISA bus signal isolated from external analog and digital signals
Timer	-
Digital I/O	2 opto-isolated inputs, 4 opto-isolated outputs
Interrupt	
Interrupt Request Causes	-
Interrupt Request Level	-
I/O address	4 port occupation
Power consumption (Max.)	+5VDC 1600mA
Bus/ Dimension (mm)	AT Bus /163.0(L)x122.0(H)
Connector	37-pin female D-type
Option	
Software	ACX-PAC(W32)BP, ACX-PAC(W32)AP, API-PAC(W32), SUPPORT-PAC(PC)352, DDE SERVER(W32)
Accessories	DTP-3(PC), DTP-4(PC), EPD-37*2
Cables/Connector	PCA37P, PCB37P, PCA37PS, PCB37PS

*1:Conversion Accuracy:A value in the table is linearity error at 25 degree.
*2:Option cable of PCB37P or PCB37PS is required.

General option for Analog I/O Board

Terminal Unit

■ Screw-Type Terminal DTP-3(PC)

* Cable (1m) attached

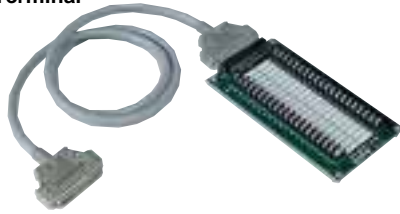

■ Screw-Type Terminal DTP-4(PC)

* Cable (1m) attached

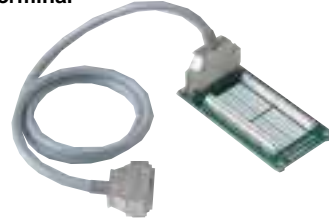

■ BNC Terminal Unit ATP-16

* Cables is option

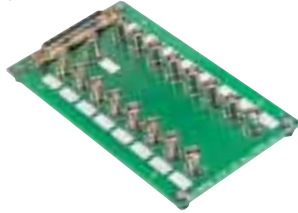

■ Terminal Unit EPD-37

35mm DIN-Rail mountable
Terminal pitch (10mm)

* Cables is option



Cables/Connector

■ 37-pin D-type → 37-pin D-type Shield Cables

PCB37PS-0.5P	0.5m
PCB37PS-1.5P	1.5m
PCB37PS-3P	3.0m
PCB37PS-5P	5.0m



■ 37-pin D-type → 37-pin D-type Flat Cables

PCB37P-1.5	1.5m
PCB37P-3	3.0m
PCB37P-5	5.0m

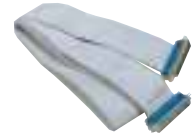

■ 37-pin D-type → 37 wires (Pitch 1.27mm) Shield Cables

PCA37PS-0.5P	0.5m
PCA37PS-1.5P	1.5m
PCA37PS-3P	3.0m
PCA37PS-5P	5.0m



■ 37-pin D-type → 37 wires (Pitch 1.27mm) Flat Cables

PCA37P-1.5	1.5m
PCA37P-3	3.0m
PCA37P-5	5.0m

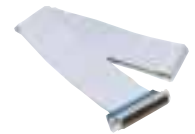

■ 37-pin D-type(female) → 37-pin D-type (female)Shield Cable

DT-11 1.5m

*For use with: AD12-8LT(PC),AD12-16LG(PC),DA12-6LC(PC)



■ 37-pin D-type(male) → 37-pin D-type (female)Flat Cable

DT-6 1.2m

*For use with: AD12-8LT(PC),AD12-16LG(PC),DA12-6LC(PC)



■ 37-pin D-type (male) Connector 5pcs

CN5-D37M

Easy soldering

F-30

ISA BUS SERIES

ISA BUS Series Selection Guide

Digital I/O Boards

Analog I/O Boards

Communication Boards

Counter & Motor Controller

ISA BUS Series
Selection
Guide

Digital I/O
Boards

**Analog I/O
Boards**

Communication
Boards

Counter &
Motor
Controller

Analog I/O Board Accessories & Cables

F-32

ISA BUS SERIES

ISA BUS Series Selection Guide

Digital I/O Boards

Analog I/O Boards

Communication Boards

Counter & Motor Controller

Connector of the Board side	Connector of the Board side				Model name of Analog I/O board				37-pin D-type			
	Accessories				Cables (both sides connector)				AD12-16(PC)EH	AD12-16U(PC)EH	AD16-16(PC)EH	AD16-16U(PC)EH
37-pin D-type	Terminal Unit EPD-37 226(W)x40.5(H)x64(D)mm 	Shield Cable PCB37PS-0.5P(0.5m) PCB37PS-1.5P(1.5m) PCB37PS-3P (3m) PCB37PS-5P (5m) 	•	•	•	•						
		Flat Cable PCB37P-1.5 (1.5m) PCB37P-3 (3m) PCB37P-5 (5m) 	•	•	•	•						
		Shield Cable DT-6 (1.2m) 										
	Screw-Type Terminal DTP-3(PC) 190(W)x105(H)mm 	Attached Cable for DTP-3(PC) (1m) 	•	•	•	•						
		Shield Cable DT-6 (1.2m) 										
	Screw-Type Terminal DTP-4(PC) 160(W)x82(H)mm 	Attached Cable for DTP-4(PC) (1m) 	•	•	•	•						
		Shield Cable DT-6 (1.2m) 										
	BNC Terminal Unit ATP-16 190(W)x105(H)mm 	Shield Cable PCB37PS-0.5P(0.5m) PCB37PS-1.5P(1.5m) PCB37PS-3P (3m) PCB37PS-5P (5m) 	•	•	•	•						
	Flat Cable PCB37P-1.5 (1.5m) PCB37P-3 (3m) PCB37P-5 (5m) 	•	•	•	•							
Signal Conditioning Terminal ATLF-8 105(W)x230(H)x22.5(D)mm 	Shield Cable PCB37PS-0.5P(0.5m) PCB37PS-1.5P(1.5m) PCB37PS-3P (3m) PCB37PS-5P (5m) 	•	•	•	•							
	Flat Cable PCB37P-1.5 (1.5m) PCB37P-3 (3m) PCB37P-5 (5m) 	•	•	•	•							
Isolated Signal Conditioning Terminal ATII-8A 105(W)x230(H)x22.5(D)mm 	Shield Cable PCB37PS-0.5P(0.5m) PCB37PS-1.5P(1.5m) PCB37PS-3P (3m) PCB37PS-5P (5m) 	•	•	•	•							
	Flat Cable PCB37P-1.5 (1.5m) PCB37P-3 (3m) PCB37P-5 (5m) 	•	•	•	•							
Simultaneous Sample & Hold ATSS-16 105(W)x230(H)x22.5(D)mm 	Shield Cable PCB37PS-0.5P(0.5m) PCB37PS-1.5P(1.5m) PCB37PS-3P (3m) PCB37PS-5P (5m) 	•	•	•	•							
	Flat Cable PCB37P-1.5 (1.5m) PCB37P-3 (3m) PCB37P-5 (5m) 	•	•	•	•							
15-pin D-type	Terminal Unit FTP-15 190(W)x105(H)mm 	Flat Cable PCB15P-1.5 (1.5m) PCB15P-3 (3m) PCB15P-5 (5m) 	•	•	•	•						
		Flat Cable DT/E2 	•	•	•	•						

* DIO Accessories

	AD12-16(PC)	AD12-16(PC)	AD12-8CL(PC)H	AD12-8LT(PC)	AD12-16LG(PC)	DA12-8L(PC)	DA12-4(PC)	DA16-4D(PC)	DAI2-4C(PC)	DAI2-8C(PC)	DA12-6LC(PC)
	●	●	●								
	●	●	●			●	●	●	●	●	
				●	●						●
	●	●	●			●	●	●	●	●	
				●	●						●
	●	●	●			●	●	●	●	●	
				●	●						●

DIN Rail Adapter

DIN-ADP1



DIN-rail adapter for termination panels

- For use with:
ATSS-16, ATII-8A,
ATLF-8, ATP-16,
FTP-15

Analog I/O Board Cables

F-34

ISA BUS SERIES







ISA BUS Series Selection Guide

Digital I/O Boards

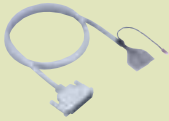
Analog I/O Boards

Communication Boards

Counter & Motor Controller

Connector of the Board side		Model name of Analog I/O board				37-pin D-type				
Cables (both sides connector)		AD12-16(PC)EH	AD12-16U(PC)EH	AD16-16(PC)EH	AD16-16U(PC)EH					
37-pin D-type	Flat Cable PCA37P-1.5 (1.5m) PCA37P-3 (3m) PCA37P-5 (5m) 		•	•	•	•				
	Shield Cable PCA37PS-0.5P (0.5m) PCA37PS-1.5P (1.5m) PCA37PS-3P (3m) PCA37PS-5P (5m) 		•	•	•	•				
	Coaxial Cable PCC16PS-1.5 (1.5m) PCC16PS-3 (3m) 		•	•	•	•				
	Shield Cable for Differential Inputs PCD8PS-1.5 (1.5m) PCD8PS-3 (3m) 		•	•	•	•				
15-pin D-type	Flat Cable PCA15P-1.5 (1.5m) PCA15P-3 (3m) PCA15P-5 (5m)  * DIO Accessories	Flat Cable DT/E2 	•	•	•	•				
16-pin Header	Flat Cable DT-E1 (1.5m)  * DIO Accessories		•	•	•	•				

	AD12-16(PC)	AD12-16(PC)	AD12-8CL(PC)H	AD12-8LT(PC)	AD12-16LG(PC)	DA12-8L(PC)	DA12-4(PC)	DA16-4D(PC)	DAI2-4C(PC)	DAI2-8C(PC)	DA12-6LC(PC)
	•	•	•			•	•	•	•	•	
	•	•	•			•	•	•	•	•	

Communication Boards

F-36

ISA BUS SERIES

2 Port RS-232C Interface Board COM-2(PC)F

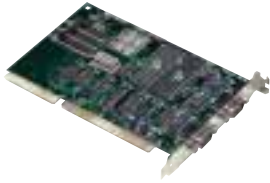

SPECIFICATIONS

Interface Type	RS-232C
Channels	2ch
Speed	50-115,200bps
Data type	5-8 bits / 1,1.5,2 stop bit
Parity Check	even, odd, non-parity
Com port	COM 1,2,3,4
Controller	16550 or equivalent
Interrupt	Compatible mode :Two of IRQ 3-7,9-12,14 or 15 Enhance mode :One of IRQ 3-7,9-12,14 or 15"
Maxim distance	15m
I/O address	Any 16-byte boundary

FEATURES

- 2-channel asynchronous communication
- Max. of 4 boards / 8 channels can be installed in one system
- Programmable communication rate from 50 to 115,200bps

Power consumption (Max.)	+5VDC 420mA, DC+12V 60mA, DC-12V 50mA
Connector	9-pin male D-type DELC-J9PAF-20L9 [JAE] or equivalent
Bus/Dimension (mm)	AT Bus /163.0(L)x107.0(H)
Option	
Software	API-PAC(W32), SUPPORT-PAC(PC)103, DDE SERVER(W32), DDE-PLC WIN
Accessories	-
Cables/Connector	RSS-9M/F, RSS-9F, RSS-25M/9F, RSC-25F/9F

2 Port Intelligent RS-232C Interface Board COM-2S(PC)



SPECIFICATIONS

Interface Type	RS-232C
Channels	2ch
Speed	300-19,200bps
Data type	7,8 bits / 1,2 stop bit
Parity Check	even, odd, non-parity
Com port	-
Controller	HD64B180 or equivalent
Interrupt	One of IRQ 3-7,9
Maxim distance	15m
I/O address	Any 8-byte boundary
Power consumption (Max.)	+5VDC 480mA, DC+12V 35mA, DC-12V 50mA

FEATURES

- 2 Port Intelligent RS-232C Interface Board
- Programmable communication rate from 300 to 19,200bps

Connector	9-pin male D-type DELC-J9PAF-20L9 [JAE] or equivalent
Bus/Dimension (mm)	XT Bus /143.0(L)x107.0(H)
Option	
Software	API-PAC(W32), SUPPORT-PAC(PC)104
Accessories	-
Cables/Connector	RSS-9M/F, RSC-9F, RSS-25M/9F, RSC-25F/9F

*Attached connector

4 Port RS-232C/RS-422A Interface Board COM-4M(PC)

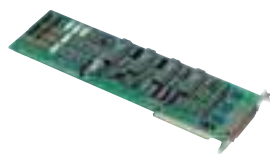

SPECIFICATIONS

Interface Type	RS-232C, RS-422A*
Channels	4ch
Speed	50-38,400bps
Data type	5-8 bits / 1,1.5,2 stop bit
Parity Check	even, odd, non-parity
Com port	COM 1,2
Controller	16550 or equivalent
Interrupt	Compatible mode : Two of IRQ 3-7,9 Enhance mode :One of IRQ 3-7,9
Maxim distance	RS-232C:15m RS-422A:1.2Km
I/O address	Any 32-byte boundary

FEATURES

- 4 channel serial communication
- Programmable communication rate from 50 to 38,400bps

Power consumption (Max.)	+5VDC 800mA, DC+12V 180mA, DC-12V 180mA
Connector	RS-232C: 37-pin female D-type DC-37SA-N [JAE] or equivalent RS-422A: 40-pin header PC-40PE-D4T1-PN1 [JAE] or equivalent
Bus/Dimension (mm)	XT Bus /340.5(L)x107.0(H)
Option	
Software	API-PAC(W32), SUPPORT-PAC(PC)103, DDE SERVER(W32), DDE-PLC WIN
Accessories	-
Cables/Connector	PCE-37/25PS, PCE-37/9PS, COM-4M CABLE(PC)1, COM-4M CABLE(PC)3

*:Changed by a Jumper switch on board.

High Speed 2 Port Isolated RS-422/RS-485 Board COM-2PD(PC)H



SPECIFICATIONS

Interface Type	RS-422A, RS-485
Channels	2ch
Speed	50-921,600bps
Data type	5-8 bits / 1,1.5,2 stop bit
Parity Check	even, odd, non-parity
Com port	COM 1,2,3,4
Controller	16550 or equivalent
Interrupt	Compatible mode :Two of IRQ 3-7,9-12,14 or 15Enhance mode :One of IRQ 3-7,9-12,14 or 15

FEATURES

- 2 Channels RS-422A/RS-485
- High speed - 50 to 921,600 bps
- Full-duplex or half-duplex communication mode

Maxim distance	1.2Km
I/O address	Any 16-byte boundary
Power consumption (Max.)	+5VDC 480mA
Connector	9-pin D-type DELC-J9PAF-20L9
Bus/Dimension (mm)	AT Bus /163.0(L)x122.0(H)
Option	
Software	API-PAC(W32), SUPPORT-PAC(PC)103, DDE SERVER(W32), DDE-PLC WIN
Accessories	-
Cables/Connector	-

IEEE-488/GPIB Interface Board GP-IB(PC)L

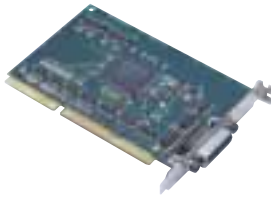

GPIB

FEATURES

- Conforming to the IEEE-488.2 standard, the GP-IB(PC)L can exchange signals with a variety of external devices compliant with the standard
- The board can use the CONTEC FPGA (μ PD7210C compatible) as a GPIB controller for long-term stable supply

SPECIFICATIONS

Interface Type	IEEE488.1, IEEE488.2
Channels	1ch
Speed	400Kbyte/sec(Max.)(DMA mode)
Data Format	8 parallel lines, 3 handshake lines
Signal logic	Low level : 0.8V or less, High level : 2.0V or more
Controller chip	CONTEC original FPGA (μ PD7210C compatible)
Interrupt	one interrupt request signal as INTA
I/O address	Any 32-byte boundary
Cable length between device	4m or less
Total cable length	20m or less
Connectable number of device	Max. 15 devices

Power consumption (Max.)	+5VDC 350mA
Connector	555139-2 (AMP)
Bus/Dimension (mm)	AT Bus /163.0(L)x107.0(H)
Option	
Software	ACX-PAC(W32)BP, ACX-PAC(W32)AP, API-PAC(W32), SUPPORT-PAC(PC)202, SUPPORT-PAC(PC)202
Accessories	CN-GP
Cables/Connector	PCN-02, PCN-04

DMA IEEE-488/GPIB Interface Board GP-IB(PC)F

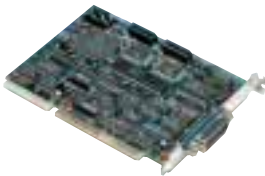

GPIB

Memory on board



FEATURES

- 1MB/second max. transfer rate using FIFO Memory
- Built in 256KB send/receive buffers
- On board i8254 compatible timer supports timer and DACK count capability
- NEC μ PD7210C controller that handles up to 15 devices

SPECIFICATIONS

Interface Type	IEEE488.1, IEEE488.2
Channels	1ch
Speed	[DMA] Send/Receive : 60Kbyte/sec, [FIFO] Send :700Kbyte/sec, Receive :1Mbyte/sec
Data Format	8 parallel lines, 3 handshake lines
Signal logic	TTL-level (Negative logic)
DMA Channels	CH1-CH3 (jumper selectable)
Controller chip	μ PD7210 or equivalent
Interrupt	One of IRQ 3-7,9-12,14 or 15
I/O address	Any 17-byte boundary
Cable length between device	4m or less
Total cable length	20m or less

Connectable number of device	Max. 15 devices
Power consumption (Max.)	+5VDC 750mA
Connector	57LE-20240-77C0D35G [DDK] or equivalent
Bus/Dimension (mm)	AT Bus / 163.0(L)x122.0(H)
Option	
Software	ACX-PAC(W32)BP, ACX-PAC(W32)AP, API-PAC(W32), SUPPORT-PAC(PC)202
Accessories	CN-GP
Cables/Connector	PCN-02, PCN-04

IEEE-488 Interface Board GP-IB(PC)

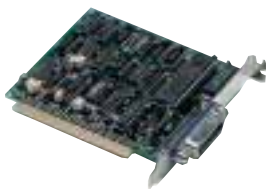

GPIB



FEATURES

- NEC μ PD7210C controller that handles up to 15 devices
- GP-IB(PC) library software supports IEEE-488 talker, listener and controller functions
- 300 KB/second max. transfer rate using DMA

SPECIFICATIONS

Interface Type	IEEE-488.1
Channels	1ch
Speed	300Kbyte/sec
Data Format	8 parallel lines, 3 handshake lines
Signal logic	TTL-level (Negative logic)
DMA Channels	CH1-CH3 (jumper selectable)
Controller chip	μ PD7210 or equivalent
Interrupt	One of IRQ 3-7,9
I/O address	Any 9-byte boundary
Cable length between device	4m or less
Total cable length	20m or less

Connectable number of device	Max. 15 devices
Power consumption (Max.)	+5VDC 400mA
Connector	57LE-20240-77C0D35G [DDK] or equivalent
Bus/Dimension (mm)	XT Bus /116.0(L)x107.0(H)
Option	
Software	ACX-PAC(W32)BP, ACX-PAC(W32)AP, API-PAC(W32), SUPPORT-PAC(PC)202
Accessories	CN-GP
Cables/Connector	PCN-02, PCN-04

F-37

ISA BUS SERIES

ISA BUS Series Selection Guide

Digital I/O Boards



Analog I/O Boards

Communication Boards

Counter & Motor Controller

Communication Board Accessories & Cables

Cable for COM-4M(PC)

■ 37-pin D-type → 9-pin D-type (male) x 4 Shield Cable (0.25m)
PCE37/9PS  



■ 37-pin D-type → 25-pin D-type (male) x 4 Shield Cable (0.25m)
PCE37/25PS  



■ 37-pin D-type → 25-pin D-type (female) x 4 Shield Cable (0.45m)
COM-4M CABLE(PC)1



Communication Board Cables

RS-232C Straight Cable

■ 9-pin D-type (male) → 9-pin D-type (female) Shield Cable (1.8m)
RSS-9M/F  



■ 25-pin D-type (male) → 25-pin D-type (female) Shield Cable (1.8m)
RSS-25M/F  





■ 25-pin D-type (male) → 9-pin D-type (female) Shield Cable (1.8m)
RSS-25M/9F  





■ 25-pin D-type (female) → 9-pin D-type (male) Shield Cable (1.8m)
RSS-25F/9M  



RS-232C Cross Cable

■ 9-pin D-type (female) → 9-pin D-type (female) Shield Cable (1.8m)
RSC-9F  



■ 25-pin D-type (female) → 25-pin D-type (female) Shield Cable (1.8m)
RSC-25F  



■ 25-pin D-type (female) → 9-pin D-type (female) Shield Cable (1.8m)
RSC-25F/9F  



: Double shield cable

: UL Mark

Cable & Accessories

GPIB Cable

PCN-02 2m
PCN-04 4m

High noise eliminate
and high reliable
GPIB cable



GPIB Connector Adapter

CN-GP

The connector
adapter is useful
when slot is tough
to insert board.

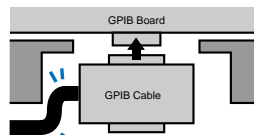

When a GPIB cable conflicts
With a case, please use a CN-GP.

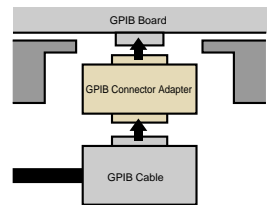

Counter & Motor Controller

4 Channel 24-Bit Up/Down Counter

CNT24-4(PC)



- FEATURES**
- 24-bit up/down counter
 - Counts two phase signals from devices like a rotary encoder or a linear gauge
 - Opto-isolated input or TTL level input for each channel

SPECIFICATIONS

Channels	4ch
Counting system	Up/Down
Input type	Single-phase input /Two-phase input
Response frequency	Opto-isolated : 500 KHz (Duty: 50%) TTL: 1 MHz (Duty: 50%)
Timer	1msec - 120sec
Max. count	24-bit binary
Input specification	Opto-isolated : 220Ω TTL : One TTL load
Interrupt	IRQ 3-7, 9-12, 14 and 15
I/O address/Expansion function	Any 2-byte boundary / Digital filter
Power consumption (Max.)	+5VDC 300mA

Bus/Dimension (mm)	AT Bus / 163.0(L)x122.0(H)
Connector	Opto-isolated : 37-pin Female D-type TTL : 30-pin header (Male)
Option	
Software	API-PAC(W32), SUPPORT-PAC(PC)502, DDE SERVER(W32)
Accessories	DTP-3(PC), DTP-4(PC), EPD-37**
Cables/Connector	PCA37P, PCB37P, PCA37PS, PCB37PS, DT/O, DT/B2

*1:Option cable of PCB37P or PCB37PS is required.

32 Channel 16-Bit Intelligent Counter

CNT16-32S(PC)

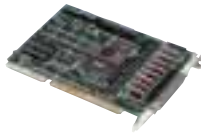

- FEATURES**
- 32 Channel 16-bit counters
 - On board CPU for solving complex timing problems
 - Operating mode of each channel is software selectable

SPECIFICATIONS

Channels	32ch
Counting system	Single phase input
Input type	Opto-isolated
Response frequency	200Hz/30Hz
Timer	2 - 7 x 10 ⁷ μsec
Max. count	16-bit binary
Input specification	Opto-Isolated Input
Interrupt	IRQ3-7, 9-12, 14 and 15 (jumper selectable)
I/O address/Expansion function	Any 16-byte boundary / Digital filter

Power consumption (Max.)	+5VDC 700mA
Bus/Dimension (mm)	AT Bus /163.0(L)x122.0(H)
Connector	37-pin female D-type
Option	
Software	-
Accessories	DTP-3(PC), DTP-4(PC), EPD-37**
Cables/Connector	PCA37P, PCB37P, PCA37PS, PCB37PS

*1:Option cable of PCB37P or PCB37PS is required.

3 Axis Stepper Motor Controller

SMC-3(PC)



- FEATURES**
- Three LSI MPG 1020 pulse generator chips from MYCOM provide output speeds up to 6M pps.
 - Four internal interrupt request channels available, one for each MPG when pulse output is completed and one channel for all three MPGs
 - All channels, besides the pulse output channels, are opto-isolated from the outside source

SPECIFICATIONS

Channels	3ch
Pulse output type	Open collector output(Software selectable logic, positive or negative)
Output signal	CW/CCW or pulse/direction
Pulse rate [pps]	92-6Mpps
Limit signal	
Signal	4 signals/ch (ORG, +LIM, -LIM, Slow-Down)
Signal type	Opto-isolated input : 12-24VDC
Input resistance	3.3KΩ
General Purpose Input	
Signal	2 inputs per MPG Emergency stop option (jumper selectable) 2 outputs per MPG
Signal type	Opto-isolated input : 12-24VDC
Input resistance	3.3KΩ

*1:Option cable of PCB37P or PCB37PS is required.

General Purpose Output	
Signal	2 channels/ch
Signal type	Opto-Isolated Open Collector Output
Output rating	+35VDC, 200mA(Max.)
Controller chip	MPG1020x3(MYCOM)
Interrupt	IRQ 3-7, 9-12, 14 and 15
I/O address	4 port occupation
Power consumption (Max.)	+5VDC 600mA
Connector	37-pin female D-type
Bus/Dimension (mm)	AT Bus /163.0(L)x122.0(H)
Option	
Software	API-PAC(W32)
Accessories	DTP-3(PC), DTP-4(PC), EPD-37**
Cables/Connector	PCA37P, PCB37P, PCA37PS, PCB37PS

High speed 2 Axis Stepper Motor Controller STP-2M(PC)

FEATURES

- 2 axes stepper motion control
- Signal format: CW/CCW or pulse/direction
- Pulse output rate up to 245,730Hz

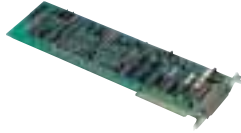

Non Isolated

SPECIFICATIONS

Channels	2ch
Pulse output type	Open collector output(+30VDC 100mA)
Output signal	CW/CCW or pulse/direction
Pulse rate [pps]	1-8191pps(x1), 30-245730pps(x30)
Limit signal	
Signal	5/ch (ORG, +LIM, -LIM)
Signal type	Opto-Isolated Input(+12 - 24VDC)
Input resistance	2KΩ
General Purpose Input	
Signal	8 channels
Signal type	Opto-Isolated Input
Input resistance	2KΩ
General Purpose Output	
Signal	8 channels
Signal type	Opto-Isolated Open Collector Output
Output rating	+35VDC, 200mA(Max.)

Controller chip	PLC-240K [NPM]
Interrupt	IRQ 3-7, 9
I/O address	Any 32-byte boundary
Power consumption (Max.)	+5VDC 850mA
Connector	Pulse output : 37-pin female D-type General purpose Digital I/O : 30-pin header (Male)
Bus/Dimension (mm)	XT Bus /340.5(L)x107.0(H)
Option	
Software	-
Accessories	DTP-3(PC), DTP-4(PC), EPD-37*
Cables/Connector	PCA37P, PCB37P, PCA37PS, PCB37PS, DT/O

*:General Purpose I/O cable is attached.
*1.Option cable of PCB37P or PCB37PS is required.

Counter Board Accessories & Cable

Terminal Unit (32ch I/O)

EPD-37

35mm DIN-Rail mountable
Compatible Boards : 32ch I/O Boards
Terminal pace 10mm

*:Cable is option

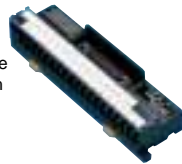

DTP-3(PC)



*:Cable(1m)attached

DTP-4(PC)

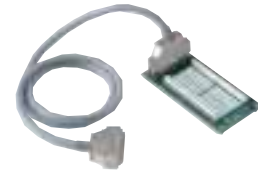

*:Cable(1m)attached

Cables/Connector

37-pin D-type → 37-pin D-type Shield Cables

PCB37PS-0.5P	0.5m
PCB37PS-1.5P	1.5m
PCB37PS-3P	3.0m
PCB37PS-5P	5.0m



37-pin D-type → 37-pin D-type Flat Cables

PCB37P-1.5	1.5m
PCB37P-3.0	3.0m
PCB37P-5.0	5.0m



37-pin D-type → 37 wires (Pitch 1.27mm) Shield Cables

PCA37PS-0.5P	0.5m
PCA37PS-1.5P	1.5m
PCA37PS-3P	3.0m
PCA37PS-5P	5.0m



37-pin D-type → 37 wires (Pitch 1.27mm) Flat Cables

PCA37P-1.5	1.5m
PCA37P-3	3.0m
PCA37P-5	5.0m

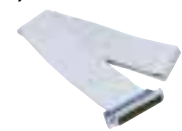

37-pin D-type (male) Connector 5pcs

CN5-D37M

- Easy soldering